



POLARIS®

RZR®



**2018
OWNER'S MANUAL**

**RZR® 570
RZR® 570 EPS**

⚠ WARNING

Read, understand, and follow all of the instructions and safety precautions in this manual and on all product labels.

Failure to follow the safety precautions could result in serious injury or death.

⚠ WARNING

The engine exhaust from this product contains chemicals known to the State of California to cause cancer, birth defects or other reproductive harm.



For videos and more information about a safe riding experience with your Polaris vehicle, scan this QR code with your smartphone.

WELCOME

Thank you for purchasing a POLARIS vehicle, and welcome to our world-wide family of POLARIS enthusiasts. Be sure to visit us online at www.polaris.com for the latest news, new product introductions, upcoming events, career opportunities and more.

Here at POLARIS we proudly produce an exciting line of utility and recreational products.

- Snowmobiles
- All-terrain vehicles (ATVs)
- Low emission vehicles (LEVs)
- *RANGER*® utility vehicles
- BRUTUS® work vehicles
- SLINGSHOT® three wheel motorcycles
- *RZR*® sport vehicles
- GEM® electric vehicles
- VICTORY® motorcycles
- INDIAN® motorcycles
- POLARIS POWER® generators
- POLARIS DEFENSE® combat vehicles

We believe POLARIS sets a standard of excellence for all utility and recreational vehicles manufactured in the world today. Many years of experience have gone into the engineering, design, and development of your POLARIS vehicle, making it the finest machine we've ever produced.

For safe and enjoyable operation of your vehicle, be sure to follow the instructions and recommendations in this owner's manual. Review the safety DVD that came with your vehicle. Polaris also recommends that all drivers take the ROHVA safety e-course and a ROHVA hands-on safety training course (www.rohva.org).

Your manual contains instructions for minor maintenance, but information about major repairs is outlined in the POLARIS Service Manual and can be performed by a factory certified Master Service Dealer® (MSD) Technician.

Your POLARIS dealer knows your vehicle best and is interested in your total satisfaction. Your POLARIS dealership can provide for all of your service needs during, and after, the warranty period.



POLARIS®

POLARIS® and RZR® are trademarks of POLARIS Industries Inc.

Copyright 2017 POLARIS Industries Inc. All information contained within this publication is based on the latest product information at the time of publication. Due to constant improvements in the design and quality of production components, some minor discrepancies may result between the actual vehicle and the information presented in this publication. Depictions and/or procedures in this publication are intended for reference use only. No liability can be accepted for omissions or inaccuracies. Any reprinting or reuse of the depictions and/or procedures contained within, whether whole or in part, is expressly prohibited.

The original instructions for this vehicle are in English. Other languages are provided as translations of the original instructions.

Printed in U.S.A.

2018 RZR 570/RZR 570 EPS Owner's Manual

P/N 9928359

TABLE OF CONTENTS

Introduction	4
Safety	7
Features and Controls	24
Operation	52
Winch Guide	71
Emission Control Systems	82
Maintenance	83
Specifications	132
POLARIS Products	132
Troubleshooting	133
Warranty	137
Maintenance Log	143
Index	144

INTRODUCTION

The RZR is an off-road vehicle. Familiarize yourself with all laws and regulations concerning the operation of this vehicle in your area.

The following signal words and symbols appear throughout this manual and on your vehicle. Your safety is involved when these words and symbols are used. Become familiar with their meanings before reading the manual.



The safety alert symbol indicates a potential personal injury hazard.

DANGER

A DANGER indicates a hazardous situation that, if not avoided, will result in death or serious injury.

WARNING

A WARNING indicates a hazardous situation that, if not avoided, could result in death or serious injury.

CAUTION

A CAUTION indicates a hazardous situation that, if not avoided, could result in minor or moderate injury.

NOTICE

A NOTICE indicates a situation that could result in property damage.



The Prohibition Safety Sign indicates an action NOT to take in order to avoid a hazard.



The Mandatory Action Sign indicates an action that NEEDS to be taken to avoid a hazard.

⚠ WARNING

Failure to heed the warnings and safety precautions contained in this manual can result in severe injury or death. Your POLARIS vehicle is not a toy and can be hazardous to operate. This vehicle handles differently than cars, trucks or other off-road vehicles. A collision or rollover can occur quickly, even during routine maneuvers like turning, or driving on hills or over obstacles, if you fail to take proper precautions.

- Read this owner's manual and review the safety DVD that came with your vehicle. A free extra copy of the DVD can be obtained by contacting your local POLARIS dealer. Understand all safety warnings, precautions and operating procedures before operating the vehicle. Keep this manual with the vehicle.
- This vehicle is an **ADULT VEHICLE ONLY**. You **MUST** be at least age 16 and have a valid driver's license to operate this vehicle.
- All riders must be able to sit with backs against the seat, both feet flat on the floor and both hands on the steering wheel (if driving) or on a passenger hand hold.
- Always use the cab nets (or doors) while riding in this vehicle. Always keep hands, feet and all other body parts inside the vehicle at all times.
- Always wear a helmet, eye protection, gloves, long-sleeve shirt, long pants and over-the-ankle boots.
- Never use this vehicle with drugs or alcohol, as these conditions impair judgment and reduce operator reaction time.
- Complete the New Operator Driving Procedures outlined on pages 58-59. Never allow a guest to operate this vehicle until the guest has completed the New Operator Driving Procedures.

European Vibration and Noise

The driver-perceived noise and hand/arm and whole body vibration levels of this machinery is measured per prEN 15997.

The operating conditions of the machinery during testing:

The vehicles were in like-new condition. The environment was controlled as indicated by the test procedure(s).

The uncertainty of vibration exposure measurement is dependent on many factors, including:

- Instrument and calibration uncertainty
- Variations in the machine such as wear of components
- Variation of machine operators such as experience or physique
- Ability of the worker to reproduce typical work during measurements
- Environmental factors such as ambient noise or temperature

INTRODUCTION

Vehicle Identification Numbers

Record your vehicle's identification numbers and key number in the spaces provided. Remove the spare key and store it in a safe place. An ignition key can be duplicated only by ordering a POLARIS key blank (using your key number) and mating it with one of your existing keys. The ignition switch must be replaced if all keys are lost.



Vehicle Identification Number Stamp (Left Front Frame)

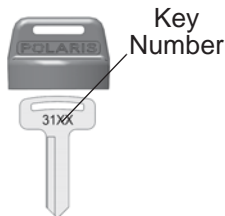

Key Number



Manufacturing Data Label (Right Front Fender Area)



Engine Serial Number

Vehicle Model Number: _____

Vehicle Identification Number: _____

Engine Serial Number: _____

Key Number _____

Safety Training

Safety training is a top priority for POLARIS. POLARIS strongly encourages you and any family members who will be riding this vehicle to take a training course.

Your POLARIS vehicle is considered an off-road vehicle. Familiarize yourself with all laws and regulations concerning the operation of this vehicle in your area.

We strongly advise you to strictly follow the recommended maintenance program outlined in your owner's manual. This preventive maintenance program is designed to ensure that all critical components on your vehicle are thoroughly inspected at specific intervals.

ROHVA (Recreational Off-Highway Vehicle Association) provides both an online safety e-course and a hands-on safety course in some areas. To access this valuable training, visit www.rohva.org.

- For more information about recreational off-road vehicle safety in North America, visit www.rohva.org or call POLARIS at 1-800-342-3764.
- For more information about recreational off-road vehicle safety outside North America, visit www.rohva.org, contact an authorized POLARIS dealer or visit the POLARIS web site at www.polaris.com.

SAFETY

Safe Riding Gear

The driver and all passengers must wear helmet, eye protection, gloves, long-sleeve shirt, long pants, over-the-ankle boots and seat belt at all times. Protective gear reduces the chance of injury.

Helmet

Wearing a helmet can prevent a severe head injury. Whenever riding this POLARIS vehicle, always wear a helmet that meets or exceeds established safety standards.

Approved helmets in the USA and Canada bear a U.S. Department of Transportation (DOT) label.

Approved helmets in Europe, Asia and Oceania bear the ECE 22.05 label. The ECE mark consists of a circle surrounding the letter E, followed by the distinguishing number of the country which has granted approval. The approval number and serial number will also be displayed on the label.

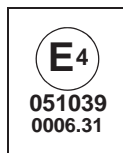

Safe Riding Gear

Eye Protection

Do not depend on eyeglasses or sunglasses for eye protection. Whenever riding this POLARIS vehicle, always wear shatterproof goggles or use a shatterproof helmet face shield. POLARIS recommends wearing approved Personal Protective Equipment (PPE) bearing markings such as VESC 8, V-8, Z87.1, or CE. Make sure protective eye wear is kept clean.

Gloves

Wear gloves for comfort and for protection from sun, cold weather and other elements.

Boots

Wear sturdy over-the-ankle boots for support and protection. Never ride a POLARIS vehicle with bare feet or sandals.

Clothing

Wear long sleeves and long pants to protect arms and legs.

Rider Comfort

Under certain operating conditions, heat generated by the engine and exhaust system can elevate temperatures in the driver and passenger cab area. The condition occurs most frequently when a vehicle is being operated in high ambient temperatures at low speeds and/or high load conditions for an extended period of time. The use of certain windshield, roof and/or cab systems may contribute to this condition by restricting airflow. Any discomfort due to heat buildup in this area can be minimized by wearing proper riding apparel and by varying speeds to increase airflow.

SAFETY

Safety Labels and Locations

Warning labels have been placed on the vehicle for your protection. Read and follow the instructions of the labels on the vehicle carefully. If any of the labels depicted in this manual differ from the labels on your vehicle, always read and follow the instructions of the *labels on the vehicle*.

If an informational or graphic label becomes illegible or comes off, your POLARIS dealer can assist to purchase a replacement. Replacement *safety* labels are provided by POLARIS at no charge. The part number is printed on the label.

Proper Use Warning

WARNING

Require Proper Use of Your Vehicle

Do your part to prevent injuries:

- Do not allow careless or reckless driving.
- Make sure operators are 16 or older with a valid driver's license.
- Do not let people drive or ride after using alcohol or drugs.
- Do not allow operation on public roads (unless designated for off-highway vehicle access) - collisions with cars and trucks can occur.
- Do not exceed seating capacity: 2 occupants.

7179978

Proper Use
Warning



Fuel Transport Warning

WARNING

NEVER carry fuel or other flammable liquids on this vehicle. Failure to follow this instruction could lead to serious burn injuries or death

7185278

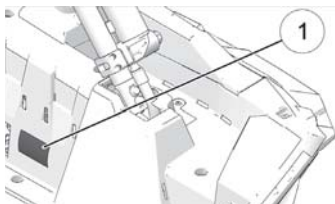

Safety Labels and Locations Seat Belt/Drive Responsibly Warning

WARNING

Improper vehicle use can result in SEVERE INJURY or DEATH

Be Prepared

- Fasten seat belts.
- Wear an approved helmet and protective gear.
- ALWAYS use cab nets and/or doors.
- Each rider must be able to sit with back against seat, feet flat on the floor, and hands on steering wheel or hand holds. Stay completely inside the vehicle.



Seat Belt/Drive Responsibly Warning

Drive Responsibly

Avoid loss of control and rollovers:

- Avoid abrupt maneuvers, sideways sliding, skidding or fishtailing, and never do donuts.
- Slow down before entering a turn.
- Avoid hard acceleration when turning, even from a stop.
- Plan for hills, rough terrain, ruts and other changes in traction and terrain.
- Avoid paved surfaces.
- Avoid sidehilling (riding across slopes).



Rollovers have caused severe injuries and death, even on flat, open areas.

Be Sure Riders Pay Attention and Plan Ahead

If you think or feel the vehicle may tip or roll, reduce your risk of injury:

- Keep a firm grip on the steering wheel or hand holds and brace yourself.
- Do not put any part of your body outside of the vehicle for any reason.

LOCATE AND READ OWNER'S MANUAL. FOLLOW ALL INSTRUCTIONS AND WARNINGS. ALWAYS REVIEW SAFETY VIDEO AND TAKE ROHVA TRAINING (rohva.org).

7179988

SAFETY

Safety Labels and Locations

Load/Passenger/Tire Pressure Warning

WARNING

- Never carry passengers in cargo box.
- Passengers can be thrown off. This can cause serious injury or death.

WARNING

IMPROPER TIRE PRESSURE OR OVERLOADING CAN CAUSE LOSS OF CONTROL RESULTING IN SERIOUS INJURY OR DEATH.

- Reduce speed and allow greater distance for braking when carrying cargo.
- Overloading or carrying tall, off-center, or unsecured loads will increase your risk of losing control. Loads should be centered and carried as low as possible in box.
- For stability on rough or hilly terrain, reduce speed and cargo.

Load/Passenger/Tire Pressure Warning



	RZR 570
MAXIMUM CARGO BOX LOAD	300 lbs. (136 kg)
TIRE PRESSURE IN PSI (KPa)	1 RIDER FRONT 7 (48) REAR 9 (62) 2 RIDERS FRONT 8 (55) REAR 10 (69)
MAXIMUM WEIGHT CAPACITY INCLUDES WEIGHT OF OPERATOR, PASSENGER, CARGO AND ACCESSORIES	740 lbs. (336 kg)
Read Operation and Maintenance Manual for more detailed loading information.	

Fuel Transport Warning

WARNING

NEVER carry fuel or other flammable liquids on this vehicle. Failure to follow this instruction could lead to serious burn injuries or death

7185278

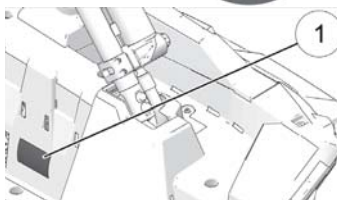

Safety Labels and Locations

Shift Caution

CAUTION

To avoid transmission damage, shift only when vehicle is stationary and at idle. When vehicle is stopped, place shift in the parked position.

APPLY BRAKE TO START

7174843

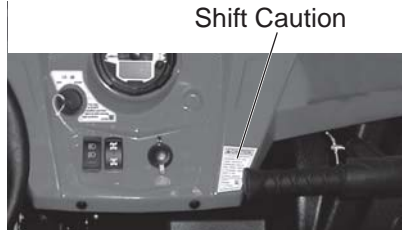

Storage Box Caution (LE Models)

CAUTION

Failure to follow these storage instructions could result in injury or property damage.

Temperatures in this storage box can exceed 150°F (65°C). Items such as lighters, sealed gasses and electronics are heat sensitive.

NEVER store such items in this box.

Storage Box Caution

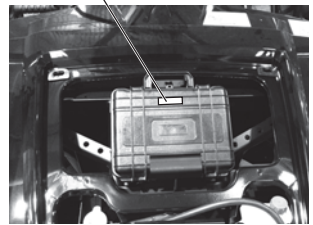

SAFETY

Safety Warnings

⚠ WARNING

Failure to operate this vehicle properly can result in a collision, loss of control, accident or rollover, which may result in serious injury or death. Heed all safety warnings outlined in this section of the owner's manual and in the safety DVD provided with your vehicle. See the OPERATION section of the owner's manual for proper operating procedures.

Operating Without Instruction

Operating this vehicle without proper instruction increases the risk of an accident. The operator must understand how to operate the vehicle properly in different situations and on different types of terrain. Complete the New Operator Driving Procedures outlined on pages 58-59.

All operators must read and understand the owner's manual and all warning and instruction labels before operating the vehicle. Never allow a guest to operate this vehicle until the guest has completed the New Operator Driving Procedures outlined on pages 58-59.

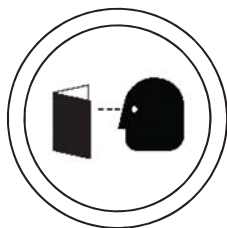

Operator Restrictions/Age Restrictions

This vehicle is an **ADULT VEHICLE ONLY**. Operation is prohibited for anyone under 16 years of age or anyone without a valid driver's license.

All riders must be able to sit with backs against the seat, both feet flat on the floor and both hands on the steering wheel (if driving) or on a passenger hand hold.



Using Alcohol or Drugs

Riding in this vehicle after consuming alcohol or drugs could adversely affect operator judgment, reaction time, balance and perception.

Never consume alcohol or drugs before or while operating or riding in this vehicle.



Safety Warnings

Failure to Inspect Before Operating

Failure to inspect and verify that the vehicle is in safe operating condition before operating increases the risk of an accident.

Always perform the pre-ride inspection before each use of your vehicle to make sure it's in safe operating condition. See page 54.

Always follow the inspection and maintenance procedures and schedules described in this owner's manual. See page 83.

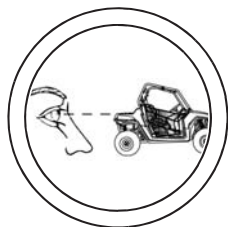

Protective Apparel

Riding in this vehicle without wearing an approved helmet and protective eyewear increases the risk of a serious injuries in the event of an accident.

Always wear a helmet, eye protection, gloves, long-sleeve shirt, long pants and over-the-ankle boots.



Seat Belts

Riding in this vehicle without wearing the seat belt increases the risk of serious injury in the event of rollover, loss of control, other accident or sudden stop. Seat belts may reduce the severity of injury in these circumstances.

All riders *must* wear seat belts at all times.

Cab Nets

Riding in this vehicle without using the cab nets (or doors, if equipped) increases the risk of serious injury or death in the event of an accident or rollover. Always use the cab nets (or doors) while riding in this vehicle. *Always keep hands and feet inside the vehicle at all times.*

SAFETY

Safety Warnings

Carrying Multiple Passengers

Never carry a passenger until you have operated this vehicle for at least two hours and have completed the New Operator Driving Procedures outlined on pages 58-59.

A passenger must always be seated in a passenger seat with seat belt secured. Carrying more than one passenger in a 2-seat vehicle can affect the operator's ability to steer and operate the controls, which increases the risk of loss of control and accident or rollover. Never carry more than one passenger in a 2-seat vehicle.



Operating With a Load on the Vehicle

The weight of both cargo and passengers impacts vehicle operation and stability. For your safety and the safety of others, carefully consider how your vehicle is loaded and how to safely operate the vehicle. Follow the instructions in this manual for loading, tire pressure, gear selection and speed.

- **Do not exceed vehicle weight capacities.** The vehicle's maximum weight capacity is listed in the specifications section of this manual and on a label on the vehicle. When more passenger weight is added, cargo weight may need to be reduced accordingly.
- The recommended tire pressures are listed in the specifications section of this manual and on a label on the vehicle.

Always follow these guidelines:

Under ANY of these conditions:	Do ALL of these steps:
Passenger and/or cargo exceeds half the maximum weight capacity	1. Slow down. 2. Verify tire pressure. 3. Use extra caution when operating.
Operating in rough terrain	
Operating over obstacles	
Climbing an incline	
Towing	

Safety Warnings

Passengers in the Cargo Box

Carrying a passenger in the cargo box could result in a fall from the vehicle or contact with moving components. Never allow a passenger to ride in the cargo box. A passenger must always be seated in a passenger seat with seat belt secured.



Operating on Pavement

This vehicle's tires are designed for off-road use only, not for use on pavement. Operating this vehicle on paved surfaces (including sidewalks, paths, parking lots and driveways) may adversely affect the handling of the vehicle and may increase the risk of loss of control and accident or rollover. Avoid operating the vehicle on pavement. If it's unavoidable, travel slowly, travel short distances and avoid sudden turns or stops.

Operating on Public Roads

Operating this vehicle on public streets, roads or highways could result in a collision with another vehicle. Never operate this vehicle on any public street, road or highway, including dirt and gravel roads (unless designated for off-highway use).

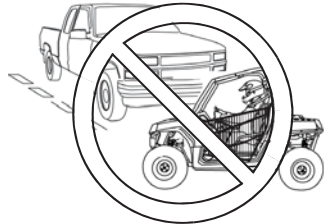

Operating at Excessive Speeds

Operating this vehicle at excessive speeds increases the operator's risk of losing control. Always operate at a speed that's appropriate for the terrain, the visibility and operating conditions, your skills and experience and your passengers' skills and experience.

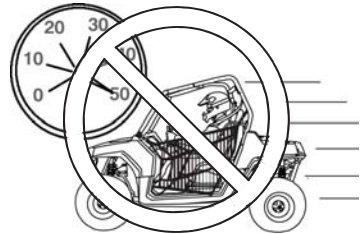

SAFETY

Safety Warnings

Turning Improperly

Turning improperly could cause loss of traction, loss of control, accident or rollover. Always follow proper procedures for turning as described in this owner's manual.

Avoid sharp turns. Never turn while applying heavy throttle. Never make abrupt steering maneuvers. Practice turning at slow speeds before attempting to turn at faster speeds.

Jumps and Stunts

Exhibition driving increases the risk of an accident or rollover. DO NOT do power slides, "donuts", jumps or other driving stunts. Avoid exhibition driving.

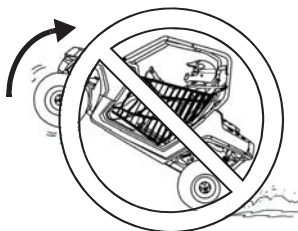

Improper Hill Climbing

Improper hill climbing could cause loss of control or rollover. Use extreme caution when operating on hills. Always follow proper procedures for hill climbing as described in this owner's manual. See page 62.

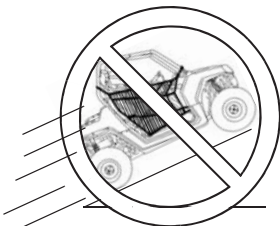

Descending Hills Improperly

Improperly descending a hill could cause loss of control or rollover. Always follow proper procedures for traveling down hills as described in this owner's manual. See page 63.

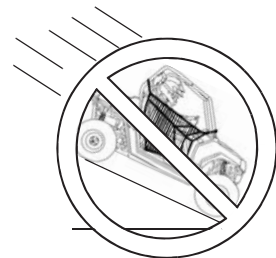

Safety Warnings

Crossing Hillsides

Driving on a sidehill is not recommended. Improper procedure could cause loss of control or rollover. Avoid crossing the side of any hill unless absolutely necessary.

If crossing a hillside is unavoidable, always follow proper procedures as described in this owner's manual. See page 63.

Stalling While Climbing a Hill

Stalling or rolling backwards while climbing a hill could cause a rollover. Maintain a steady speed when climbing a hill.

If you lose all forward speed:

Apply the brakes gradually until the vehicle is fully stopped. Place the transmission in reverse and slowly allow the vehicle to roll straight downhill while applying light brake pressure to control speed.



Operating in Unfamiliar Terrain

Failure to use extra caution when operating on unfamiliar terrain could result in an accident or rollover.

Unfamiliar terrain may contain hidden rocks, bumps, or holes that could cause loss of control or rollover.

Travel slowly and use extra caution when operating on unfamiliar terrain. Always be alert to changing terrain conditions.



SAFETY

Safety Warnings

Operating Improperly in Reverse

Improperly operating in reverse could result in a collision with an obstacle or person. Always follow proper operating procedures as outlined in this manual. See page 66.

Before shifting into reverse gear, always check for obstacles or people behind the vehicle. When it's safe to proceed, back slowly.

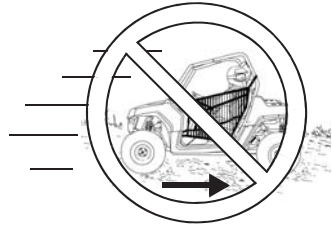

Improper Tire Maintenance

Operating this vehicle with improper tires or with improper or uneven tire pressure could cause loss of control, accident or rollover.

Always use the size and type of tires specified for your vehicle. Always maintain proper tire pressure as described in this owner's manual and on safety labels.

Skidding or Sliding

Failure to use extra caution when operating on excessively rough, slippery or loose terrain could cause loss of traction, loss of control, accident or rollover. Do not operate on excessively slippery surfaces. Always slow down and use additional caution when operating on slippery surfaces.

Skidding or sliding due to loss of traction can cause loss of control or rollover (if tires regain traction unexpectedly). Always follow proper procedures for operating on slippery surfaces as described in this owner's manual. See page 61.

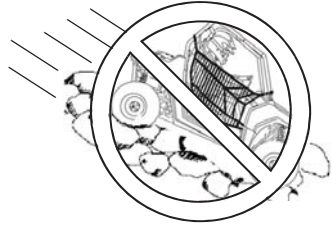

Operating Over Obstacles

Improperly operating over obstacles could cause loss of control or rollover.

Before operating in a new area, check for obstacles. Avoid operating over large obstacles such as large rocks and fallen trees. Always follow the proper procedures outlined in this manual when operating over obstacles. See page 65.



Safety Warnings

Operating Through Water

Operating through deep or fast-flowing water can cause loss of traction, loss of control, rollover or accident. Never operate in fast-flowing water or in water that exceeds the floor level of the vehicle.

Always follow proper procedures for operating in water as described in this owner's manual. See page 64.

Wet brakes may have reduced stopping ability. After leaving water, test the brakes. Apply them lightly several times while driving slowly. The friction will help dry out the pads.



Operating on Frozen Bodies of Water

Severe injury or death can result if the vehicle and/or the operator fall through the ice. Never operate the vehicle on a frozen body of water unless you have first verified that the ice is sufficiently thick to support the weight and moving force of the vehicle, you and your passenger, and your cargo, together with any other vehicles in your party.

Always check with local authorities and residents to confirm ice conditions and thickness over your entire route. Vehicle operators assume all risk associated with ice conditions on frozen bodies of water.



Operating a Damaged Vehicle

Operating a damaged vehicle can result in an accident. After any rollover or other accident, have a qualified service dealer inspect the entire machine for possible damage, including (but not limited to) seat belts, rollover protection devices, brakes, throttle and steering systems.

SAFETY

Safety Warnings

Improper Cargo Loading

Overloading the vehicle or carrying/towing cargo improperly may cause changes in stability and handling, which could cause loss of control or an accident.

- Always follow the instructions in this owner's manual for carrying cargo. See page 68.
- Never exceed the stated load capacity for this vehicle. See page 12.
- Cargo should be properly distributed and securely attached. See page 68.
- Reduce speed when carrying cargo or pulling a trailer. Allow a greater distance for braking.

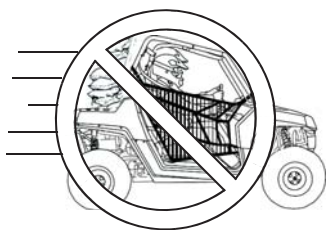

Refueling

Gasoline is highly flammable and explosive under certain conditions.

- Always exercise extreme caution whenever handling gasoline.
- Always turn off the engine when refueling.
- Always refuel outdoors or in a well ventilated area free of any source of flame or sparks.
- Always use an approved gasoline container to store fuel and remove the container from the vehicle before filling to avoid fuel ignition due to electrical static discharge.
- Do not smoke or allow open flames or sparks in or near the area where refueling is performed or where gasoline is stored.
- Do not overfill the tank. Do not fill the tank neck.
- If gasoline spills on your skin or clothing, immediately wash it off with soap and water and change clothing.

Safety Warnings

Exposure to Exhaust

Engine exhaust fumes are poisonous and can cause loss of consciousness or death in a short time. Never start the engine or let it run in an enclosed area.

Operate this vehicle only outdoors or in well-ventilated areas.

Hot Exhaust Systems

Exhaust system components are very hot during and after use of the vehicle. Hot components can cause burns and fire. Do not touch hot exhaust system components. Always keep combustible materials away from the exhaust system. Use caution when traveling through tall grass, especially dry grass, to avoid debris build-up around the exhaust system.

Unauthorized Use of the Vehicle

Leaving the keys in the ignition can lead to unauthorized use of the vehicle by someone under the age of 16, without a drivers license, or without proper training. This could result in an accident or rollover. Always remove the ignition key when the vehicle is not in use.

Equipment Modifications

Your POLARIS vehicle is designed to provide safe operation when used as directed. Modifications to your vehicle may negatively impact vehicle stability. Failure of critical machine components may result from operation with any modifications, especially those that increase speed or power. This vehicle may become less stable at speeds higher than those for which it is designed. Loss of control may occur at higher speeds.

Do not install any non-POLARIS-approved accessory or modify the vehicle for the purpose of increasing speed or power. Any modifications or installation of non-POLARIS-approved accessories could create a substantial safety hazard and increase the risk of bodily injury.

The POLARIS limited warranty on your POLARIS vehicle will be terminated if any non-POLARIS-approved equipment and/or modifications have been added to the vehicle that increase speed or power.

The addition of certain accessories, including (but not limited to) mowers, blades, tires, sprayers, or large racks, may change the handling characteristics of the vehicle. Use only POLARIS-approved accessories, and familiarize yourself with their function and effect on the vehicle.

FEATURES AND CONTROLS

Component Locations

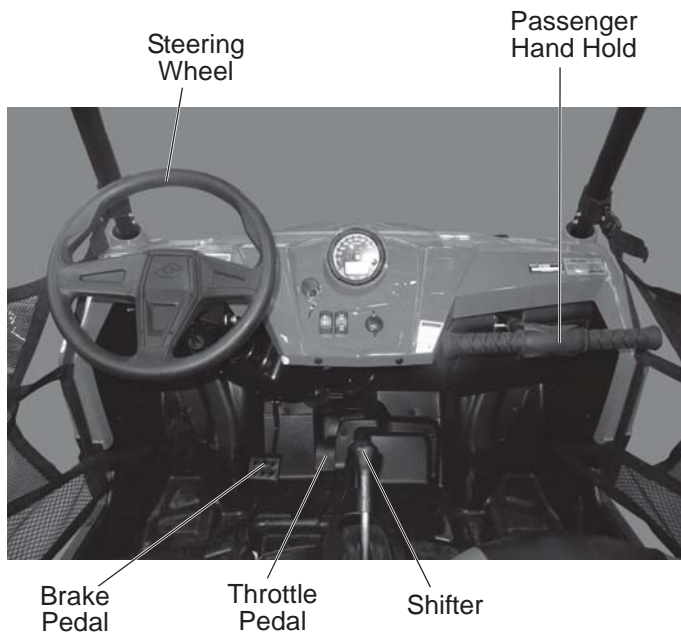
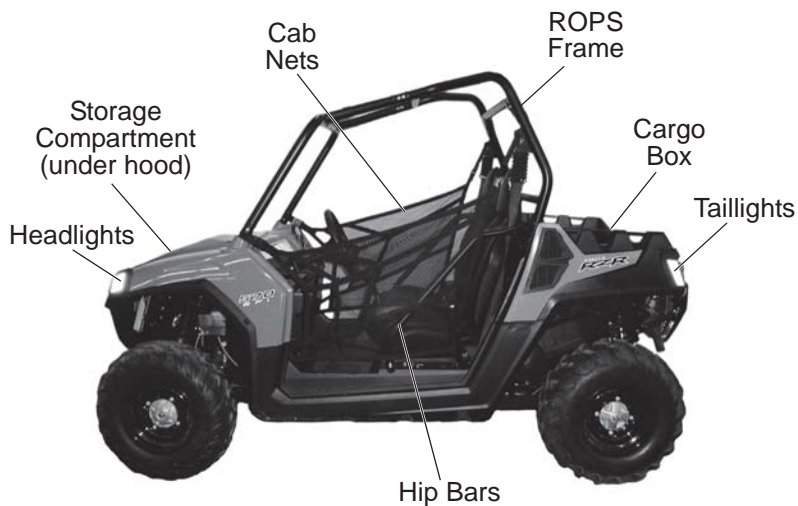

FEATURES AND CONTROLS

Component Locations



Trailer Receiver Hitch Bracket

This vehicle is equipped with a receiver hitch bracket for a trailer hitch. Trailer towing equipment is not supplied with this vehicle.

To avoid injury and property damage, always heed the warnings and towing capacities outlined on pages 68-70.

Radiator Access/Grill Removal

The front grill can be removed to clean debris from the radiator. Push down on the two tabs and pivot the grill outward to remove it.

Service Access Panels

The engine access panel is located behind the seats on the frame of the vehicle. Remove the seats and remove the access panel to reach some serviceable engine components

The rear access panel is located in the bed of the cargo box. Remove this access panel to access the air box and spark plug.

FEATURES AND CONTROLS

Steering Wheel

The steering wheel can be tilted upward or downward for rider preference.

Lift and hold the steering wheel adjustment lever while moving the steering wheel upward or downward. Release the lever when the steering wheel is at the desired position.



Adjustment Lever

Passenger Hand Hold

Always adjust the hand hold to a comfortable position for your passenger before operating. Make sure the adjustment pin and retainer are securely installed after making adjustments.

1. Remove the retainer from the end of the adjustment pin.
2. Remove the pin from the post.
3. Slide the post inward or outward to the desired position.
4. Reinstall the pin through the post mounting hole, adapter bushing hole, both post adjustment holes and lastly through the remaining bushing hole and post mounting hole.
5. Reinstall the retainer to the pin.

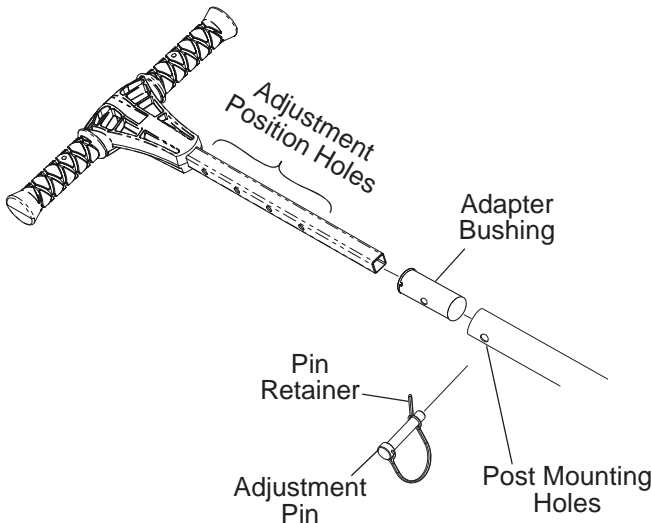

FEATURES AND CONTROLS

Hood

Remove the hood to access the radiator cap, coolant overflow bottle and sealed storage box (LE model).

1. Turn the hood fasteners 1/4 turn.
2. Grasp the upper hood edge and pull upward to disengage the hood from the vehicle.
3. Pivot the hood forward and lift upward to disengage the lower hood hooks.
4. Lift the hood away from the vehicle.

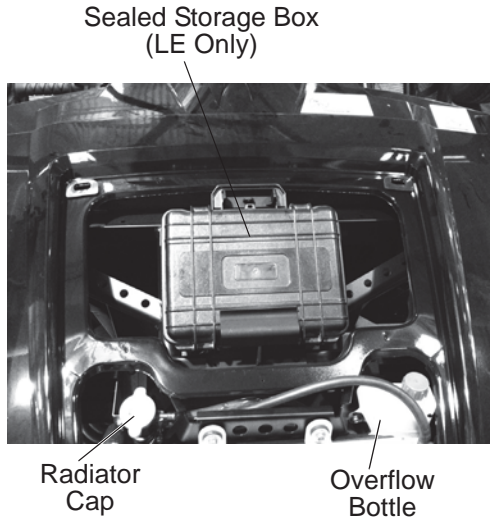

Cab Nets

All RZR models are equipped with cab nets, which may differ slightly in appearance from those shown.

Riding in this vehicle without using the cab nets (or doors, if equipped) increases the risk of serious injury or death in the event of an accident or rollover. Cab nets (or doors) must be used by both operator and passengers at all times. Make sure all latches are secure before operating the vehicle.



Always inspect cab nets and latches for tightness, wear and damage before each use of the vehicle. Use the strap adjusters to tighten any loose straps. Promptly replace worn or damaged cab nets and latches with new cab nets and latches.

FEATURES AND CONTROLS

Fuel Cap

The fuel tank filler cap is located on the right side of the vehicle near the passenger seat. When refueling, always use either leaded or unleaded gasoline with a minimum pump octane number of 87 R+M/2 octane. *Do not use fuel with ethanol content greater than 10 percent, such as E-85 fuel.*

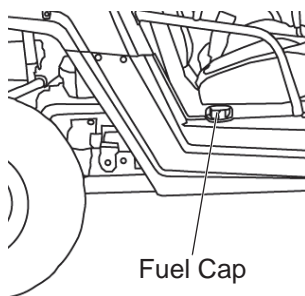

Seats

Before operating the vehicle, always push down on all seat backs to ensure the latches are secure.

Seat Adjustments

Loosen (do not remove) the four screws located on the seat bottom. Slide the seat forward or rearward to the desired position. Tighten the screws to 4 ft. lbs. (5.4 Nm). Do not overtighten.

Seat Removal

1. Pull up on the seat latch lever located under the rear edge of the seat.
2. Tilt the seat forward.
3. Lift the seat upward to remove it from the vehicle.
4. Reverse this procedure to reinstall the seat. Make sure the seat tabs at the front edge of the seat slide under the seat retainer bar.
5. Press down firmly at the rear of the seat to engage the rear latch.

Seat Latch



FEATURES AND CONTROLS

Seat Belts

This POLARIS vehicle is equipped with seat belts for all riders. Always make sure the seat belts are secured for the operator and passenger before riding. The driver's seat belt is equipped with a seat belt interlock. Vehicle speed will be limited to 15 MPH (24 km/h) if the seat belt is not secured.

3-Point Seat Belt

To wear the 3-point seat belt properly, follow this procedure:

1. Pull the seat belt latch downward and across your chest toward the buckle at the inner edge of the seat. The belt should fit snugly across your hips and diagonally across your chest. Make sure the belt is not twisted.
2. Push the latch plate into the buckle until it clicks. Pull up on the strap to tighten.
3. Press the red release latch on the buckle to release the seat belt.

Seat Belt Height Adjuster (if equipped)

A breakthrough in comfort, the seat belt height adjuster reduces neck rub and works as a shock absorber for your shoulder. The height adjuster consists of an adjuster (1) and a rail (2). (3) designates the adjustment zone.

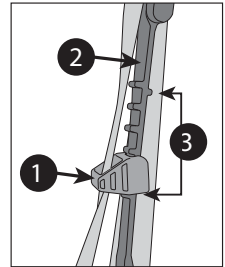

HOW TO ADJUST THE HEIGHT OF YOUR SEAT BELT FOR DESIRED COMFORT AND PROPER FIT

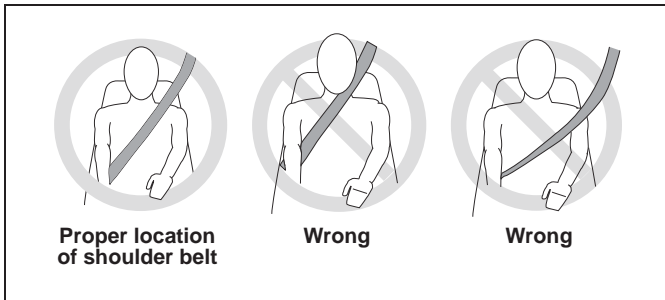

continued on next page

FEATURES AND CONTROLS

Seat Belts

Seat Belt Height Adjuster (if equipped)

STEP 1

Stretch the seat belt height adjuster toward the front of the vehicle.

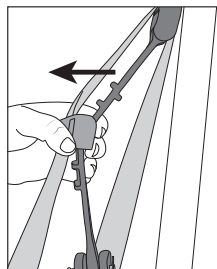

STEP 1

STEP 2

While continuing to stretch the seat belt height adjuster, slide the adjuster up or down, rocking it side to side if necessary, until you reach the desired height. This may require both hands. Do not attempt to adjust while vehicle is in motion.

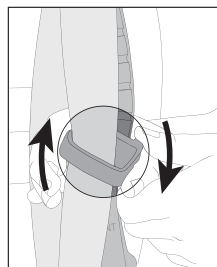

STEP 2

NOTE: Adjustment becomes easier with repeated use.

CLEANING INSTRUCTIONS: The seat belt height adjuster can be cleaned with water.

FEATURES AND CONTROLS

Seat Belts

Seat Belt Inspection

Inspect all seat belts for proper operation before each use of the vehicle.

1. Push the latch plate into the buckle until it clicks. The latch plate must slide smoothly into the buckle. A click indicates that it's securely latched.
2. Push the red release latch in the middle of the buckle to make sure it releases freely.
3. Pull each seat belt completely out and inspect the full length for any damage, including cuts, wear, fraying or stiffness. If any damage is found, or if the seat belt does not operate properly, have the seat belt system checked and/or replaced. Your authorized POLARIS dealer can assist.
4. To clean dirt or debris from the seat belts, sponge the straps with mild soap and water. Do not use bleach, dye or household detergents. Use a garden hose to flush out the retractor and latch housings regularly.



Latch Housings



Retractor
Housing

FEATURES AND CONTROLS

Switches

Ignition Switch
Light Switch (Base Model)

Instrument Cluster

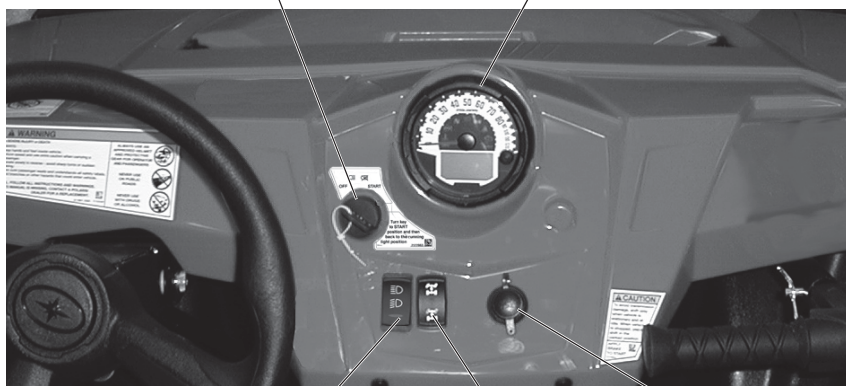

Light Switch
(LE Model)

AWD
Switch

12V Accessory
Outlet

Auxiliary Outlet

The vehicle is equipped with a 12-volt accessory outlet on the dash. Use the outlet to power an auxiliary light or other optional accessories or lights. For service, the dash outlet connection is under the dash.

FEATURES AND CONTROLS

Switches

Ignition Switch/Light Switch (Base Model)

Use the ignition switch to start the engine and to turn the lights on or off. The key can be removed from the switch when it is in the OFF position.

OFF	Turn the key to the OFF position to stop the engine. Electrical circuits are off.
LIGHTS ON	Electrical circuits are on. Electrical equipment can be used.
LIGHTS OFF	Electrical circuits are on. Electrical equipment can be used.
START	Turn the key to the START position to engage the electric starter. See page 56 for starting procedures.

Ignition Switch (LE Model)

The ignition switch is a three-position, key-operated switch. The key can be removed from the switch when it is in the OFF position.

OFF	The engine is off. Electrical circuits are off, except Acc, 12V.
ON	Electrical circuits are on. Electrical equipment can be used.
START	Turn the key to the START position to engage the electric starter. The key returns to the ON position when released.

Light Switch (LE Model)

The ignition switch key must be in the ON/RUN position to operate the headlights. Press the top of the rocker switch toward the dash to place the headlights on high beam. Move the rocker switch to the center position to place the headlights on low beam. Press the bottom of the rocker switch to turn off the headlights.

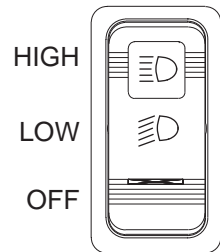

FEATURES AND CONTROLS

Switches

All Wheel Drive (AWD) Switch (if equipped)

The AWD Switch has two positions:

- All Wheel Drive (AWD)
- Two Wheel Drive (2WD).

Press the top of the rocker switch to engage All Wheel Drive. Press the bottom of the switch to operate in two wheel drive.

See page 40 for AWD operating instructions.

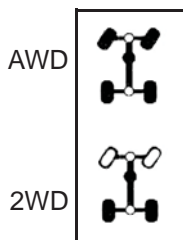

AWD/Differential Lock Switch (if equipped)

The AWD/Differential Switch has three positions:

- All Wheel Drive (AWD)
- Differential Lock (2WD)
- Differential Unlock (TURF mode)

Press the top of the rocker switch to engage All Wheel Drive (AWD). See page 42 for operating instructions.

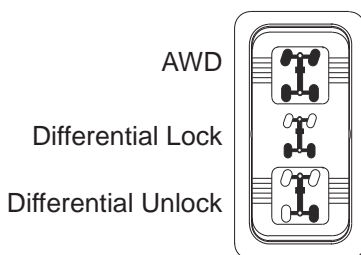

Move the rocker switch to the center position to lock the differential and operate in rear wheel drive. Press the bottom of the switch to unlock the differential and allow the two rear drive wheels to operate independently. See page 42 for differential lock operating instructions.

WARNING! Never operate in TURF mode (if equipped) while operating on a hill or other irregular terrain. Always move the AWD switch to AWD before ascending or descending a hill. See page 43.

FEATURES AND CONTROLS

Gear Selector

P: Park

R: Reverse

N: Neutral

L: Low Gear

H: High Gear

To change gears, stop the vehicle, and with the engine idling, move the lever to the desired gear. Do not attempt to shift gears with engine speed above idle or while the vehicle is moving.



Gear Selector

Tip: Maintaining shift linkage adjustment is important to assure proper transmission function. Your POLARIS dealer can assist in resolving any shifting problems.

NOTICE: Do not attempt to shift the transmission while the vehicle is moving or damage to the transmission could result. Always shift when the vehicle is stationary and the engine is at idle.

Using Low Range

Always shift into low gear for any of the following conditions.

- Operating in rough terrain or over obstacles
- Loading the vehicle onto a trailer
- Towing heavy loads

FEATURES AND CONTROLS

Brake Pedal

Depress the brake pedal to slow or stop the vehicle. Apply the brakes while starting the engine.

Throttle Pedal

Push the pedal down to increase engine speed. Spring pressure returns the pedal to the rest position when released. Always check that the throttle pedal returns normally before starting the engine.

Tip: If the throttle pedal and brake pedal are applied simultaneously, engine power may be limited.

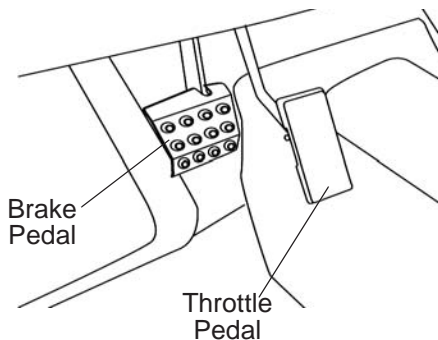

FEATURES AND CONTROLS

Park Brake Lever (if equipped)

Always apply the service brakes before engaging or releasing the park brake. To help prevent the vehicle from rolling, set the park brake when parking the vehicle. When the park brake is set and the park brake indicator is illuminated, engine speed is limited. If the accelerator is applied, this limiting feature prevents operation, which protects the park brake pads from excessive wear.

Tip: This feature will not operate properly if the park brake connector or switch (under the hood) malfunctions or becomes disconnected, or if the switch has moved. Check for disconnection, then see your dealer or other qualified service person promptly if this feature fails to operate properly.

1. To set the park brake, apply the brakes.
2. Pull the park brake lever upward as far as possible.
3. To release the park brake, apply the brakes. Press the park brake release inward and move the lever downward as far as possible.

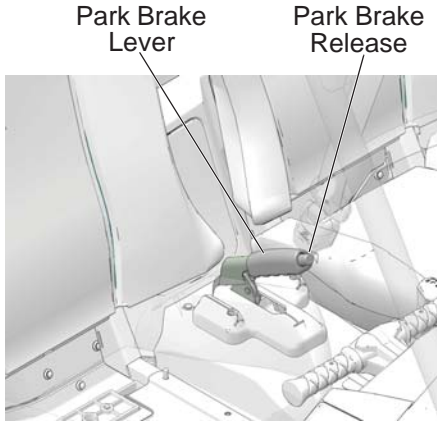

FEATURES AND CONTROLS

Rollover Protective Structure (ROPS)

The Rollover Protective Structure (ROPS) on this vehicle meets OSHA 1928.53 rollover performance requirements. Always have authorized service personnel or your POLARIS dealer thoroughly inspect the ROPS if it ever becomes damaged in any way.

No device can assure occupant protection in the event of a rollover. When used with seat belts and cab nets, the ROPS helps prevent occupants from being ejected from the vehicle. Always follow all safe operating practices outlined in this manual to avoid vehicle rollover.

WARNING! Vehicle rollover could cause severe injury or death. Always avoid operating in a manner that could result in vehicle rollover.

ROPS Label



FEATURES AND CONTROLS

Electronic Power Steering (EPS)

Electronic power steering (if equipped) engages when the ignition key is turned to the ON position. EPS remains engaged whether the vehicle is moving or idle.

The EPS warning indicator briefly illuminates when the key is turned to the ON position. See page 45.

To conserve battery power, the EPS will shut down 5 minutes after the engine is stopped if the key remains in the ON position. The EPS warning indicator will illuminate to indicate the EPS has shut down.

If the light remains on after starting the engine, the EPS system is inoperative. Your POLARIS dealer can assist.



Power Steering Unit
(under cover)

FEATURES AND CONTROLS

All Wheel Drive (AWD) System

For models equipped with a rear differential, refer to the All Wheel Drive/Rear Differential section beginning on page 41.

On models not equipped with a rear differential, the All Wheel Drive system is controlled by the AWD switch. When the switch is on 2X4, the vehicle is in two-wheel drive at all times. When the switch is on AWD, the vehicle is in all wheel drive and the 4X4 indicator in the instrument cluster will be on.

When in AWD, the demand drive unit will automatically engage any time the rear wheels lose traction. When the rear wheels regain traction, the demand drive unit will automatically disengage.

There is no limit to the length of time the vehicle may remain in AWD.

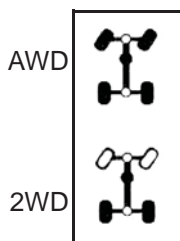

Engaging AWD

The AWD switch may be turned on or off while the vehicle is moving. Initially, the vehicle's electronic system will not enable the AWD until the engine RPM is below 3100. Once enabled, the AWD remains enabled until the AWD switch is turned off. If the switch is turned off while the demand drive unit is moving, it will not disengage until the rear wheels regain traction.

Engage the AWD switch before getting into conditions where front wheel drive may be needed. If the rear wheels are spinning, release the throttle before switching to AWD.

NOTICE: Switching to AWD while the rear wheels are spinning or slipping may cause severe drive shaft and gearcase damage. Always switch to AWD while the rear wheels have traction or are at rest.

FEATURES AND CONTROLS

All Wheel Drive/Rear Differential System

Engaging AWD

Press the top of the switch to engage All Wheel Drive (AWD). The 4X4 indicator illuminates in the rider information center to indicate that the vehicle is in AWD. See page 47.

When the AWD switch is on, the front wheels will automatically engage any time the rear wheels lose traction. When the rear wheels regain traction, the front wheels will automatically disengage. There is no limit to the length of time the vehicle may remain in AWD.

Tip: The AWD switch may be turned on or off while the vehicle is moving.

Engage the AWD before getting into conditions where front wheel drive may be needed. If the rear wheels are spinning, release the throttle before switching to AWD.

NOTICE: Switching to AWD while the rear wheels are spinning may cause severe drive shaft and clutch damage. Always switch to AWD while the rear wheels have traction or are at rest.

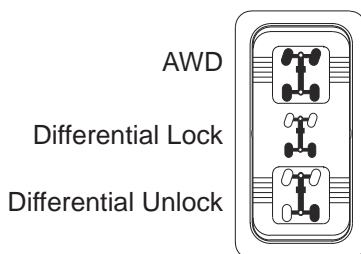

FEATURES AND CONTROLS

All Wheel Drive/Rear Differential System

Disengaging AWD

Move the AWD switch to the center or bottom position to disengage AWD. If the switch is turned off while the front hubs are driving, they will not release until the rear wheels regain traction.

In some situations, the front gearcase may remain locked after turning the AWD switch off. If this occurs, you may notice increased steering effort and some vehicle speed restriction. Perform the following procedure to unlock the front gearcase.

1. Stop the vehicle.
2. Operate in reverse for at least 10 feet (3 m).
3. Stop completely.
4. Shift into low gear and drive forward.
5. If the front gearcase remains locked after following these instructions, see your dealer for service.

Locking the Differential

NOTICE: Damage to the differential can occur if it is engaged while the vehicle is traveling at high speeds or while the rear wheels are spinning. Slow the vehicle to nearly stopped before engaging the differential.

Locking the differential in slippery or low traction conditions helps improve traction. Move the rocker switch to the center position (2WD) to lock the differential and operate in rear wheel drive. See illustration below.

FEATURES AND CONTROLS

All Wheel Drive/Rear Differential System

Unlocking the Differential/TURF Mode (LE Models Only)

When operating in TURF mode, the inside rear wheel will rotate independently from the outside wheel during turns. *Operate in TURF mode only as needed* to protect smooth, level surfaces from tire damage. **DO NOT** operate in TURF mode when climbing or descending hills, when sidehilling, or when operating on uneven, loose, or slippery terrain such as sand, gravel, ice, snow, obstacles, and water crossings. Always operate in AWD on these types of terrain.

WARNING! Operating in TURF mode (if equipped) when on sloped, uneven, or loose terrain could cause loss of control and result in serious injury or death. One rear wheel may slip and lose traction or may lift up and grab when it touches the ground again.

Press the bottom of the switch to unlock the differential and allow the rear drive wheels to operate independently. This mode of operation is well suited to turf driving or whenever aggressive traction is not required.

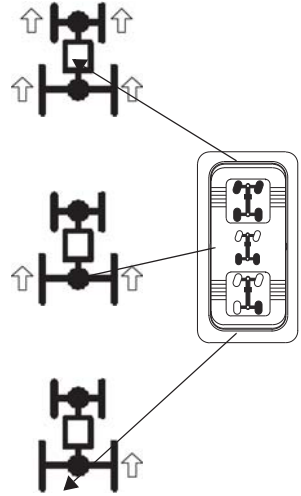

Extreme Use Battery

An optional extreme use battery may be available for your model. If the performance of the factory-installed battery is inadequate due to operation in extreme cold or due to extended use of multiple electrical accessories, your POLARIS dealer can assist. Ask your dealer to provide any installation procedures that may differ for an extreme use battery.

FEATURES AND CONTROLS

Instrument Cluster

High water pressure may damage components. Wash the vehicle by hand or with a garden hose using mild soap. Do not use alcohol to clean the instrument cluster. Do not allow insect sprays to contact the lens.

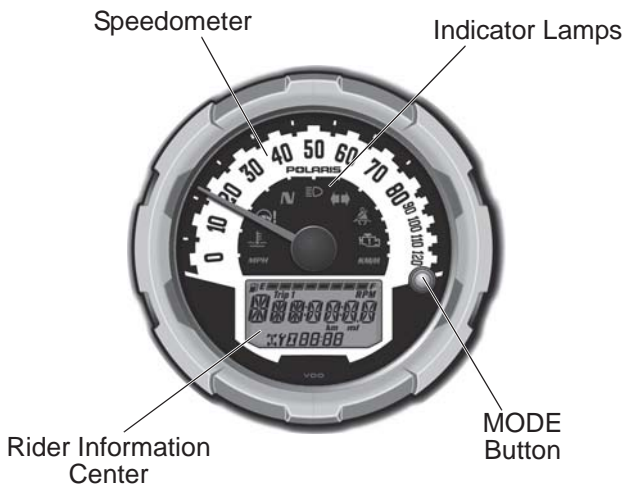

Speedometer

The speedometer displays vehicle speed in either miles per hour (MPH) or kilometers per hour (km/h). See page 48.





Mode Button

Use the MODE button to toggle through mode options. See page 48 for operation of the modes.

FEATURES AND CONTROLS

Instrument Cluster

Indicator Lamps

Lamp	Indicates	Condition
<i>MPH</i>	Vehicle Speed	When standard mode is selected, speed displays in miles per hour.
<i>KMH</i>		When metric mode is selected, speed displays in kilometers per hour.
	Over Temperature	This lamp illuminates to indicate an overheated engine. If the indicator flashes, the overheating condition remains, and the system will automatically reduce engine power.
	EPS Warning (if equipped)	This indicator illuminates briefly when the key is turned to the ON position. If the light remains on, the EPS system is inoperative. Your POLARIS dealer can assist.
<i>N</i>	Neutral	This lamp illuminates when the transmission is in neutral and the ignition key is in the ON position.
	High Beam (if equipped)	This lamp illuminates when the headlamp switch is set to high beam.
	Helmet/Seat Belt	This lamp flashes for several seconds when the key is turned to the ON position. The lamp is a reminder to the operator to ensure all riders are wearing helmets and seat belts before operating.
	Check Engine	This indicator appears if an EFI-related fault occurs. Do not operate the vehicle if this warning appears. Serious engine damage could result. Your POLARIS dealer can assist.

FEATURES AND CONTROLS

Instrument Cluster

Rider Information Center

The rider information center is located in the instrument cluster. All segments will light up for one second at start-up. If the instrument cluster fails to illuminate, a battery over-voltage may have occurred and the instrument cluster may have shut off to protect the electronic speedometer. If this occurs, your POLARIS dealer can provide proper diagnosis.

The information center is set to display standard units of measurement and a 12-hour clock at the factory. To change to metric and/or a 24-hour clock, see page 49.

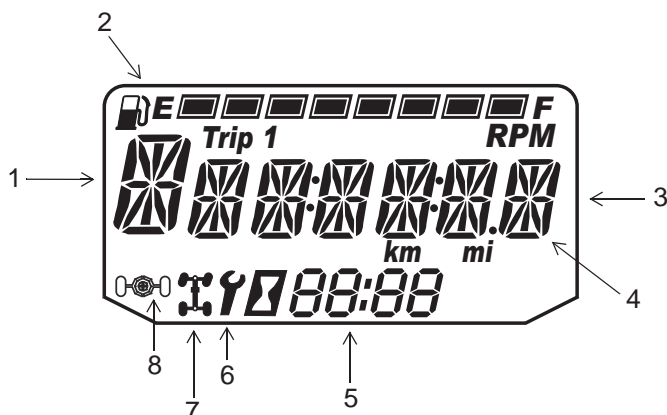

1. **Gear Indicator** - This indicator displays gear shifter position.

H = High Gear

L = Low Gear

N = Neutral

R = Reverse Gear

P = Park

-- = Gear Signal Error (or shifter between gears)

FEATURES AND CONTROLS

Instrument Cluster

Rider Information Center

2. **Fuel Gauge** - The segments of the fuel gauge show the level of fuel in the fuel tank. When the last segment clears, a low fuel warning is activated. All segments including the fuel icon will flash. Refuel immediately.

Tip: If the fuel icon fails to display, an open or short circuit has occurred in the fuel sensor circuit. Your POLARIS dealer can assist.

3. **Information Display Area** - This area displays odometer, trip meter, engine hour meter and programmable service hour interval.
4. **Under / Over Voltage** - This warning usually indicates that the vehicle is operating at an RPM too low to keep the battery charged. It may also occur when the engine is at idle and high electrical load (lights, cooling fan, accessories) is applied. Drive at a higher RPM or recharge the battery to clear the warning.
5. **Clock** - The clock displays time in a 12-hour or 24-hour format. See page 49 for resetting instructions.
6. **Service Indicator** - A flashing wrench symbol alerts the operator that the preset service interval has been reached. Your POLARIS dealer can provide scheduled maintenance. See page 49 for resetting instructions.
7. **4X4 Indicator** - This indicator illuminates when the 4X4 system is engaged (switch is on 4X4).
8. **Turf Mode Indicator (if equipped)** - This indicator illuminates when the operator unlocks the differential. See page 43.

FEATURES AND CONTROLS

Instrument Cluster

Rider Information Center

Use the MODE button to toggle through the information area options.

Display Units (Standard/Metric)

The display can be changed to show either standard or metric units of measurement for each of the following settings.

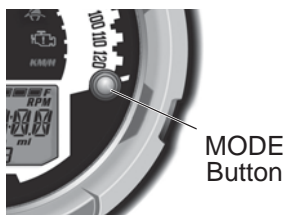

Tip: To exit the set-up mode, turn the key off. Wait 5 seconds, then turn the key on. The gauge display the mode that was displayed prior to setting the units.

	Standard Display	Metric Display
Distance	Miles	Kilometers
Fuel	U.S. Gallons	Liters, Imperial Gallons
Temperature	Fahrenheit	Celsius
Time	12-Hour Clock	24-Hour Clock

1. Turn the key to the OFF position.
2. Press and *hold* the MODE button while turning the key to the ON position.
3. When the display flashes the distance setting, tap the MODE button to advance to the desired setting.
4. Press and *hold* the MODE button to save the setting and advance to the next display option.
5. Repeat the procedure to change remaining display settings.

FEATURES AND CONTROLS

Instrument Cluster

Rider Information Center

Clock Mode

Tip: The clock must be reset any time the battery has been disconnected or discharged.

1. Turn the key to the ON position. Use the MODE button to toggle to the odometer display.
2. Press and *hold* the MODE button until the hour segment flashes. Release the button.
3. With the segment flashing, tap the MODE button to advance to the desired setting.
4. Press and *hold* the MODE button until the next segment flashes. Release the button.
5. Repeat steps 3-4 twice to set the 10-minute and 1-minute segments. After completing the 1-minute segment, step 4 will save the new settings and exit the clock mode.
6. Turn the key to the OFF position.

Odometer Mode

The odometer records and displays the distance traveled by the vehicle.

Trip Meter Mode

The trip meter records the distance traveled by the vehicle if reset before each trip. To reset, select the trip meter mode. Press and hold the MODE button until the meter resets to zero. In the Rider Information Center, the trip meter display contains a decimal point, but the odometer displays without a decimal point.

Hour Meter Mode

This mode logs the total hours the engine has been in operation.

Engine Temperature Mode

This mode displays current temperature of the coolant.

Tachometer Mode

The engine RPM is displayed digitally.

Tip: Small fluctuations in the RPM from day to day may be normal because of changes in humidity, temperature and elevation.

FEATURES AND CONTROLS

Instrument Cluster

Rider Information Center

Programmable Service Interval

When the hours of engine operation equal the programmed service interval setting, the wrench icon will flash for 5 seconds each time the engine is started. When this feature is enabled, it provides a convenient reminder to perform routine maintenance. The service interval is programmed at 50 hours at the factory. Use the following procedure to change the service interval.

1. Press the MODE button until remaining service hours display.
2. Press and hold the MODE button.
3. When the service hours flash, press and release the MODE button to advance the hours to the desired setting (including OFF). Press and hold the MODE button to set the new service hour interval.

Diagnostic Display Mode

The EFI diagnostic display mode is for informational purposes only. Your POLARIS dealer can provide for all major repairs.

The diagnostic mode is accessible only when the check engine warning indicator activates after the key has been turned on. Leave the key on if you want to view the active code (failure code).

The diagnostic mode becomes inaccessible if the key is turned off and on and the warning indicator is no longer active. This allows the determination of persistent as well as intermittent faults.

Inactive codes are stored in the history of the unit.

FEATURES AND CONTROLS

Instrument Cluster

Rider Information Center

Engine Error Codes

The error screen displays only when the CHECK ENGINE light is on or when it goes on and off during one ignition cycle. Error codes are not stored. When the key is turned OFF, the code and message is lost, but will reappear if the fault reoccurs after restarting the engine.

If the CHECK ENGINE light illuminates, retrieve the error codes from the display.

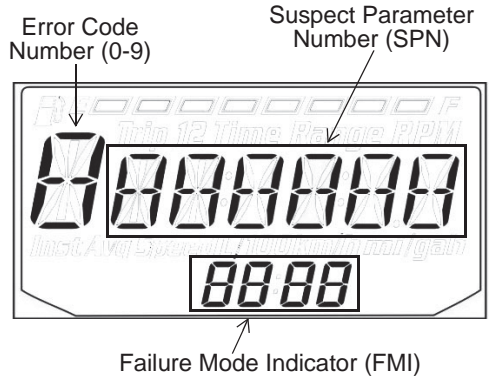

1. If the error codes are not displayed, use the MODE button to toggle until “Ck ENG” displays on the main line of the display.
2. Press and hold the MODE button to enter the diagnostics code menu.
3. Record the three numbers displayed in the gear position, clock and odometer displays.
4. Press the MODE button to advance to the next error code.
5. Press and hold the MODE button to exit the diagnostics code menu.
6. Your authorized POLARIS dealer can provide code details and diagnosis.

OPERATION

WARNING

Failure to operate the vehicle properly can result in a collision, loss of control, accident or rollover, which may result in serious injury or death. Read and understand all safety warnings outlined in the safety section of this owner's manual.

Vehicle Break-in Period

The break-in period for your new POLARIS vehicle is the first 25 hours of operation, or the time it takes to use the first two tanks full of gasoline. No single action on your part is as important as a proper break-in period. Careful treatment of a new engine and drive components will result in more efficient performance and longer life for these components. Perform the following procedures carefully.

NOTICE: Excessive heat build-up during the first three hours of operation will damage close-fitted engine parts and drive components. Do not operate at full throttle or high speeds during the first three hours of use.

Use of any improper oils may cause serious engine damage. POLARIS Premium 4 Synthetic Oil is specifically formulated for your 4-cycle engine.

Engine and Drivetrain Break-in

1. Fill the fuel tank with gasoline. See page 28. Always exercise extreme caution whenever handling gasoline.
2. Check the oil level. See page 91. Add the recommended oil as needed to maintain the oil level in the safe operating range.
3. Complete the New Operator Driving Procedures outlined on pages 58-59.
4. Avoid aggressive use of the brakes. See Brake System Break-in on page 53.
5. Vary throttle positions. Do not operate at sustained idle.
6. Pull only light loads.

Vehicle Break-in Period

Engine and Drivetrain Break-in

7. Perform regular checks on fluid levels, controls and areas outlined on the daily pre-ride inspection checklist. See page 54.
8. During the break-in period, change both the oil and the filter at 25 hours or one month.
9. Check fluid levels of transmission and all gearcases after the first 25 hours of operation and every 100 hours thereafter.

Brake System Break-in

Apply only moderate braking force for the first 50 stops. Aggressive or overly forceful braking when the brake system is new could damage brake pads and rotors.

PVT Break-in (Clutches/Belt)

A proper break-in of the clutches and drive belt will ensure a longer life and better performance. If a belt fails, always clean any debris from the duct and from the engine compartment.

Standard Break-In

Drive at slower speeds for the first 50 miles (80 km) of operation. Carry only light loads. Avoid aggressive acceleration, high-speed operation and prolonged operation at a specific RPM during this period.

Sand/Dune Break-In

Drive in low gear for the first 5 miles (8 km) of operation. Avoid prolonged low speed operation at high throttle. Avoid aggressive acceleration, high-speed operation and prolonged operation at a specific RPM during this period.

OPERATION

Pre-Ride Inspection

Failure to inspect and verify that the vehicle is in safe operating condition before operating increases the risk of an accident. Always inspect the vehicle before each use to make sure it's in safe operating condition.

Item	Remarks	Page
Brake system/pedal travel	Ensure proper operation	36 109
Brake fluid	Ensure proper level	110
Front suspension	Inspect, lubricate if necessary	88
Rear suspension	Inspect, lubricate if necessary	88
Steering	Ensure free operation	111
Tires	Inspect condition and pressure	12 113
Wheels/fasteners	Inspect, ensure fastener tightness	113
Frame nuts, bolts, fasteners	Inspect, ensure tightness	-
Fuel and oil	Ensure proper levels	47 91
Coolant level	Ensure proper level	102 101
Coolant hoses	Inspect for leaks	-
Throttle	Ensure proper operation	36
Indicator lights/switches	Ensure proper operation	33
Air filter, pre-filter	Inspect, clean	106- 107
Intake pre-filters	Inspect, clean	107
Headlamp	Check operation, apply POLARIS dielectric grease when lamp is replaced	115
Brake light/tail lamp	Check operation, apply POLARIS dielectric grease when lamp is replaced	117
Seat Latches	Push down on both seat backs to ensure the latches are secure	28
Seat Belts	Check length of belt for damage, check latches for proper operation	29
Cab Nets	Check for wear or damage, ensure proper installation	27

Safe Operation Practices

1. Visit the Recreational Off-Highway Vehicle Association web site (rohva.org) and take the free on-line training course. Complete the recommended safety training before operating this vehicle.
2. Do not allow anyone under 16 years of age or without a valid driver's license to operate this vehicle.
3. Never carry more one passenger in a 2-seat vehicle. Never allow a passenger to ride in the cargo box.
4. Engine exhaust fumes are poisonous. Never start the engine or let it run in an enclosed area.
5. Never operate with accessories not approved by POLARIS for use on this vehicle.
6. Operate this vehicle off-road only. Never operate the vehicle on pavement or on any public street, road or highway, including dirt and gravel roads.
7. Drive in a manner appropriate for your skills and operating conditions. Never operate at excessive speeds. Never attempt wheelies, jumps, or other stunts. Keep both hands on the steering wheel during operation.
8. Never consume alcohol or drugs before or while operating this vehicle.
9. Always use the size and type of tires specified for your vehicle. Always maintain proper tire pressure.
10. Never operate a damaged vehicle. After any rollover or accident, have a qualified service dealer inspect the entire machine for possible damage.
11. Never operate the vehicle on a frozen body of water unless you have first verified that the ice is sufficiently thick to support the weight and moving force of the vehicle, you and your passenger, and your cargo, together with any other vehicles in your party.
12. Do not touch hot exhaust system components. Always keep combustible materials away from the exhaust system.
13. Always remove the ignition key when the vehicle is not in use to prevent unauthorized use.

OPERATION

Starting the Engine

1. Position the vehicle on a level surface outdoors or in a well-ventilated area.
2. Sit in the driver's seat and fasten the seat belt. Secure the cab nets.
3. Place the transmission in PARK. Engage the park brake (if equipped).
4. Apply the brakes. Do not press the throttle pedal while starting the engine.
5. Turn the ignition key to the START position. Engage the starter for a maximum of five seconds. Release the key when the engine starts.
6. If the engine does not start within five seconds, return the ignition switch to the OFF position and wait five seconds. Repeat steps 5 and 6 until the engine starts.
7. Vary the engine RPM slightly with the throttle to aid in warm up until the engine idles smoothly.

NOTICE: Operating the vehicle immediately after starting could cause engine damage. Allow the engine to warm up for several minutes before operating the vehicle.

8. Release the park brake before driving (if equipped).

Stopping the Engine

1. Release the throttle pedal completely and brake to a complete stop.
2. Place the transmission in PARK.
3. Turn the engine off.
4. Slowly release the brake pedal and make sure the transmission is in PARK before exiting the vehicle.
5. Engage the park brake (if equipped).

WARNING! A rolling vehicle can cause serious injury. Always place the transmission in PARK and engage the park brake (if equipped) when stopping the engine.

Braking

1. Release the throttle pedal completely. (When the throttle pedal is released completely and engine speed slows to near idle, the vehicle has no engine braking.)
2. Press on the brake pedal evenly and firmly. Practice starting and stopping (using the brakes) until you're familiar with the controls.

Parking the Vehicle

1. Stop the vehicle on a level surface. When parking inside a garage or other structure, be sure that the structure is well ventilated and that the vehicle is not close to any source of flame or sparks, including any appliance with pilot lights.
2. Place the transmission in PARK.
3. Turn the engine off.
4. Slowly release the brake pedal and make sure the transmission is in PARK before exiting the vehicle.
5. Engage the park brake (if equipped).
6. Remove the ignition key to prevent unauthorized use.

Know Your Riding Area/Tread Lightly

Familiarize yourself with all laws and regulations concerning the operation of this vehicle in your area. Respect the environment in which you ride your vehicle. Find out where the designated riding areas are by contacting your POLARIS dealer, a local riding club, or local officials.

Help keep our trails open for recreational vehicle use. As an off-road enthusiast, you represent the sport and can set a good example (or a poor example) for others to follow. Tread lightly. Operate with respect for the terrain, avoid littering, and always stay on the designated trails.

Trail Etiquette

Always practice good etiquette when riding. Allow a safe distance between your vehicle and other vehicles operating in the same area. Communicate to oncoming operators by signaling the number of vehicles in your group. When stopping, move your vehicle to the edge of the trail as far as possible to allow others to pass safely.

OPERATION

New Operator Driving Procedures



1. Read and understand the owner's manual and all warning and instruction labels before operating this vehicle.
2. Visit the Recreational Off-Highway Vehicle Association web site (rohva.org) and take the free on-line training course. Hands-on training is also available through ROHVA.
3. Perform the pre-ride inspection. See page 54.
4. Do not carry a passenger until you have at least two hours of driving experience with this vehicle.
5. Do not tow or carry cargo during this period.
6. Select an open area that allows room to familiarize yourself with vehicle operation and handling.
7. The driver and all passengers must wear helmet, eye protection, gloves, long-sleeve shirt, long pants, over-the-ankle boots and seat belt at all times.
8. Sit in the driver's seat and fasten the seat belt.
9. Make sure all passengers secure their seat belts.
10. Make sure all cab nets are properly secured.
11. Place the transmission in PARK. Engage the park brake (if equipped).
12. Start the engine.

New Operator Driving Procedures

13. Apply the brakes and shift into low gear.
14. Check your surroundings and determine your path of travel.
15. Release the park brake (if equipped).
16. Keeping both hands on the steering wheel, slowly release the brakes and depress the throttle with your right foot to begin driving.
17. Drive slowly at first. On level surfaces, practice starting, stopping, turning, maneuvering, using the throttle and brakes and driving in reverse. Learn how the vehicle handles when making both left and right turns at a slow speed.

WARNING! Operating in TURF mode (if equipped) when on sloped, uneven, or loose terrain could cause loss of control and result in serious injury or death. One rear wheel may slip and lose traction or may lift up and grab when it touches the ground again.

18. Increase speed only after mastering all maneuvers at a slow speed.
19. After you become skilled at making turns and begin to operate at faster speeds, follow these precautions:
 - Avoid sharp turns.
 - Never turn while applying heavy throttle.
 - Never make abrupt steering maneuvers.
 - Operate at speeds appropriate for your skills, the conditions and the terrain.
 - DO NOT do power slides, “donuts”, jumps or other driving stunts.

OPERATION

Driving with a Passenger

1. Complete the New Operator Driving Procedures outlined on pages 58-59.
2. Perform the pre-ride inspection. See page 54.
3. Do not carry more than one passenger in a 2-seat vehicle. Additional passengers can affect the operator's ability to steer and operate the controls.
4. All riders must be able to sit with backs against the seat, both feet flat on the floor and both hands on the steering wheel (if driving) or on a passenger hand hold.
5. The driver and all passengers must wear helmet, eye protection, gloves, long-sleeve shirt, long pants, over-the-ankle boots and seat belt at all times. See page 8.
6. Make sure all passengers secure their seat belts.
7. Make sure all cab nets are properly secured.
8. Allow a passenger to ride only in the passenger seat.
9. Slow down. Always travel at a speed appropriate for your skills, your passenger's skills and operating conditions. Avoid unexpected or aggressive maneuvers that could cause discomfort or injury to a passenger.
10. Vehicle handling may change with a passenger and/or cargo on board. Allow more time and distance for braking.
11. Always follow all operating guidelines as outlined on safety labels and in this manual.



Driving on Slippery Surfaces

When driving on slippery surfaces such as wet trails, loose gravel, or ice, be alert for the possibility of skidding and sliding.

Follow these precautions when encountering slippery conditions:

1. Slow down before entering slippery areas.
2. Maintain a high level of alertness, reading the trail and avoiding quick, sharp turns, which can cause skids.
3. Engage all-wheel drive before wheels begin to lose traction.

NOTICE: Severe damage to the drive train may occur if the AWD is engaged while the wheels are spinning. Always allow the wheels to stop spinning before engaging AWD.

4. Correct a skid by turning the steering wheel in the direction of the skid. *Never apply the brakes during a skid.*

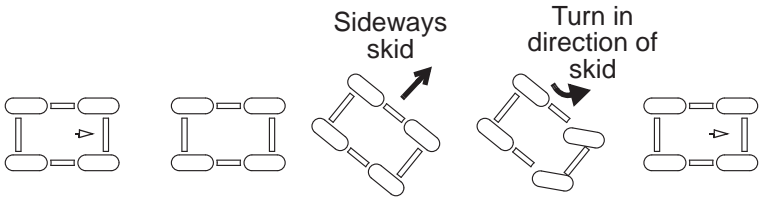

OPERATION

Driving Uphill

Whenever traveling uphill, follow these precautions:

1. Always check the terrain carefully before ascending any hill. Never drive on hills with excessively slippery or loose surfaces.
2. Never operate in TURF mode (if equipped) while operating on a hill or other irregular terrain. Always move the AWD switch to AWD before ascending or descending a hill. See page 43.
3. Avoid excessively steep hills. If ascending a steeper grade is unavoidable, engage all-wheel drive before ascending.
4. Drive straight uphill.
5. Proceed at a steady rate of speed and throttle opening. Never open the throttle suddenly.
6. Avoid unnecessary changes in speed or direction.
7. Never go over the crest of a hill at high speed. An obstacle, a sharp drop, or another vehicle or person could be on the other side of the hill.
8. If the vehicle stalls while climbing a hill, apply the brakes. Place the transmission in reverse and slowly allow the vehicle to roll straight downhill while applying light brake pressure to control speed.

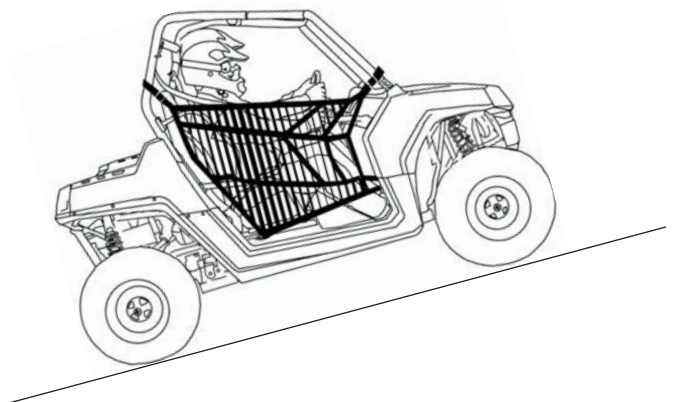

Driving on a Sidehill (Sidehilling)

Driving on a sidehill is not recommended. Improper procedure could cause loss of control or rollover. Avoid crossing the side of any hill unless absolutely necessary.

If crossing a hill is *unavoidable*, follow these precautions:

1. Engage all-wheel drive.
2. Never operate in TURF mode (if equipped) while operating on a hill or other irregular terrain. Always move the AWD switch to AWD before ascending or descending a hill. See page 43.
3. Drive slowly and use extreme caution.
4. If the vehicle begins to overturn, or if it feels as if it may overturn, *immediately* turn downhill.
5. Avoid obstacles and changes in terrain that may lower or raise one side of the vehicle or cause the vehicle to slide.
6. If the vehicle begins to slide downhill, immediately turn downhill to stop the slide, or stop the vehicle and maneuver slowly and carefully until the vehicle can be driven straight downhill.

Driving Downhill

Whenever descending a hill, follow these precautions:

1. Avoid excessively steep hills.
2. Never operate in TURF mode (if equipped) while operating on a hill or other irregular terrain. Always move the AWD switch to AWD before ascending or descending a hill. See page 43.
3. Slow down. Never travel down a hill at high speed.
4. Always check the terrain carefully before descending a hill. Never drive on hills with excessively slippery or loose surfaces.
5. Always descend a hill with the transmission in forward gear. *Never descend a hill with the transmission in neutral.*
6. Avoid traveling down a hill at an angle, which would cause the vehicle to lean sharply to one side. Travel straight downhill.
7. Apply the brakes *lightly* to aid in slowing.

OPERATION

Driving Through Water

Your vehicle can operate through water with a maximum recommended depth equal to floor level. Follow these precautions when operating through water:

1. Determine water depth and current before entering water.
2. Choose a crossing where the water level is lowest and where both banks have gradual inclines. Never operate in water that exceeds the maximum recommended depth.



WARNING! The large tires on your vehicle may cause the vehicle to float in deep or fast-flowing water, which could result in loss of traction, loss of control, rollover or accident.

3. Wet brakes may have reduced stopping ability. After leaving water, test the brakes. Apply them lightly several times while driving slowly. The friction will help dry out the pads.

NOTICE: Major engine damage can result if the vehicle is not thoroughly inspected after operation in water. Perform the services outlined in the maintenance chart. See page 83. Give special attention to engine oil, transmission oil, demand drive fluid, rear gearcase oil (if equipped), and all grease fittings.

If your vehicle becomes immersed or is operated in water that exceeds the floor level, *service is required before starting the engine.* Your POLARIS dealer can provide this service. If it's impossible to bring the vehicle in before starting the engine, perform the service outlined on page 117, and take the vehicle in for service at the first opportunity.

Driving Over Obstacles

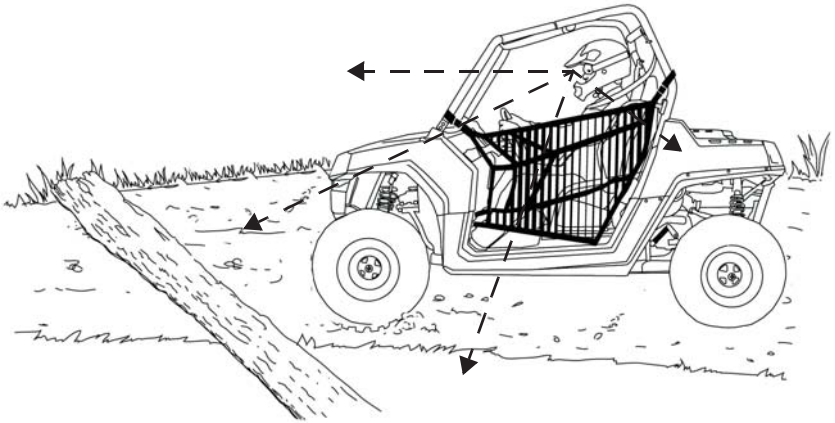

Follow these precautions when operating over obstacles:

1. Always check for obstacles before operating in a new area.
2. Look ahead and learn to read the terrain. Be constantly alert for hazards such as logs, rocks and low hanging branches.
3. Travel slowly and use extra caution when operating on unfamiliar terrain. Not all obstacles are immediately visible.
4. Avoid operating over large obstacles such as large rocks and fallen trees. If unavoidable, use extreme caution and operate slowly.
5. Always have a passenger dismount and move away from the vehicle before operating over an obstacle that could cause a rollover.

OPERATION

Driving in Reverse

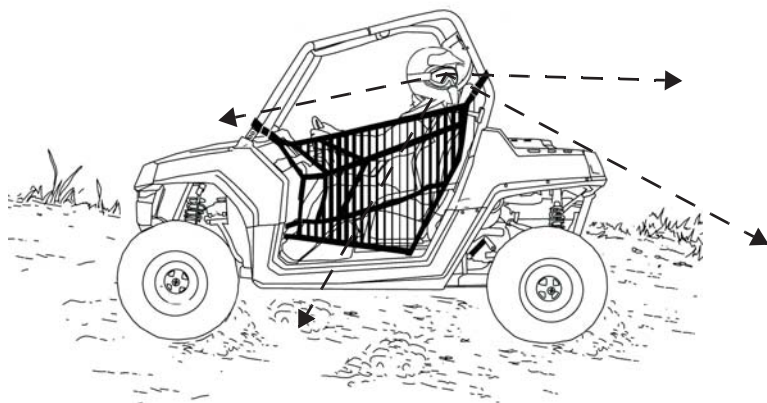

Follow these precautions when operating in reverse:

1. Always check for obstacles or people behind the vehicle.
2. Apply the throttle *lightly*. Never open the throttle suddenly.
3. Back slowly.
4. Apply the brakes *lightly* for stopping.
5. Avoid making sharp turns.

Parking on an Incline

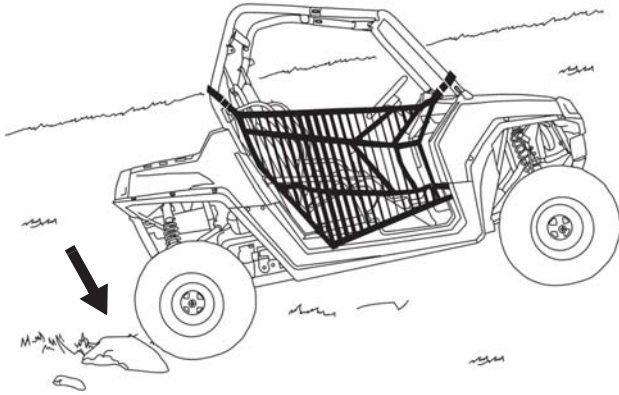

A rolling vehicle can result in serious injury. Avoid parking on an incline. If parking on an incline is *unavoidable*, follow these precautions:

1. Place the transmission in PARK.
2. Turn the engine off.
3. Slowly release the brake pedal and make sure the transmission is in PARK before exiting the vehicle.
4. Engage the park brake (if equipped).
5. Block the rear wheels on the downhill side, or park the vehicle in a sidehill position instead.

OPERATION

Hauling Cargo

⚠ WARNING

Overloading the vehicle or carrying or towing cargo improperly can alter vehicle handling and may cause loss of control or brake instability. Always follow these precautions when hauling cargo:

Never exceed the stated load capacity for this vehicle.

REDUCE SPEED AND ALLOW GREATER DISTANCES FOR BRAKING WHEN HAULING CARGO.

NEVER EXCEED THE MAXIMUM WEIGHT CAPACITY of the vehicle. When determining the weight you are adding to the vehicle, include the weight of the operator, passenger, accessories, loads in the rack or box and the load on the trailer tongue. The combined weight of these items must not exceed the maximum weight capacity.

Always load the cargo box with the load as far forward and as low as possible.

When operating over rough or hilly terrain, reduce speed and cargo to maintain stable driving conditions.

Always operate the vehicle with extreme care when hauling or towing loads. Slow down and drive in the lowest gear available.

SECURE ALL LOADS BEFORE OPERATING. Unsecured loads can create unstable operating conditions, which could result in loss of control of the vehicle.

OPERATE ONLY WITH STABLE AND SAFELY ARRANGED LOADS. When handling off-centered loads that cannot be centered, securely fasten the load and operate with extra caution. Always attach the tow load to the hitch point designated for your vehicle.

HEAVY LOADS CAN CAUSE BRAKING AND CONTROL PROBLEMS. Use extreme caution when applying brakes with a loaded vehicle. Avoid terrain or situations that may require backing downhill.

USE EXTREME CAUTION when operating with loads that extend over the rack sides. Stability and maneuverability may be adversely affected, causing vehicle rollover.

DO NOT TRAVEL FASTER THAN THE RECOMMENDED SPEEDS. Vehicle should never exceed 10 MPH (16 km/h) while towing a load on a level grass surface. Vehicle speed should never exceed 5 MPH (8 km/h) when towing loads in rough terrain, while cornering, or while ascending or descending a hill.

Carrying a passenger in the cargo box could result in a fall from the vehicle or contact with moving components. Never allow a passenger to ride in the cargo box. A passenger must always be seated in the passenger seat with seat belt secured.



Hauling Cargo

Your POLARIS vehicle has been designed to carry or tow specific capacities. Reduce speed and allow a greater distance for braking when carrying cargo.

Loads should be centered and carried as low as possible in the box. For stability on rough or hilly terrain, reduce both speed and cargo. Exercise caution if the cargo load extends over the side of the box.

Always read and understand the load distribution warnings listed on warning labels and in this manual. Never exceed the maximum capacities specified for your vehicle. See page 130.

Belt Life

To extend belt life, use low gear in the following conditions:

- when hauling or towing heavy cargo.
- when consistently operating at speeds less than 35 MPH (56 km/h) in hard-pulling terrain, such as mud, rocks or sand/dune environments.

OPERATION

Towing Loads

WARNING

Towing improperly can alter vehicle handling and may cause loss of control or brake instability.

Always follow these precautions when towing:

1. Never load more than 150 lbs. (68.1 kg) tongue weight on the towing bracket.
2. Towing a trailer increases braking distance. Do not operate the vehicle faster than 10 MPH (16 km/h) when towing.
3. Do not tow more than the recommended weight for the vehicle.
4. Attach a trailer to the trailer hitch bracket only. Do not attach a trailer to any other location, which could result in loss of control of the vehicle.
5. The total load (operator, passenger, accessories, cargo and weight on hitch) must not exceed the maximum weight capacity of the vehicle.

Total Towed Load Weight (Level Ground)	Total Towed Load Weight (15° grade)	Total Hitch Vertical Weight	Maximum Towing Speed
1500 lbs. (681 kg)	850 lbs. (386 kg)	150 lbs. (68.1 kg)	10 MPH (16 km/h)

Towing a RZR

Towing this vehicle is not recommended. Always transport the vehicle on a trailer or flatbed with all four wheels off the ground. See page 129.

If towing a disabled vehicle is unavoidable, place the disabled vehicle's transmission in neutral. Tow the shortest distance possible. Do not operate faster than 10 MPH (16 km/h).

WINCH GUIDE

These safety warnings and instructions apply if your vehicle came equipped with a winch or if you choose to add an accessory winch to your vehicle.

⚠ WARNING

Improper winch use can result in SEVERE INJURY or DEATH. Always follow all winch instructions and warnings in this manual.

Your winch may have a cable made of either wire rope or specially designed synthetic rope. The term “winch cable” will be used for either unless noted otherwise.

Winch Safety Precautions

1. Read all sections of this manual.
2. Never use alcohol or drugs before or while operating the winch.
3. Never allow children under 16 years of age to operate the winch.
4. Always wear eye protection and heavy gloves when operating the winch.
5. Always keep body, hair, clothing and jewelry clear of the winch cable, fairlead and hook when operating winch.
6. Never attempt to “jerk” a load attached to the winch with a moving vehicle. See the *Shock Loading* section on page 80.
7. Always keep the area around the vehicle, winch, winch cable and load clear of people (especially children) and distractions while operating the winch.
8. Always turn the vehicle ignition power OFF when it and the winch are not being used.
9. Always be sure that at least five (5) full turns of winch cable are wrapped around the winch drum at all times. The friction provided by this wrapped cable allows the drum to pull on the winch cable and move the load.

WINCH GUIDE

Winch Safety Precautions

10. Always apply your vehicle's park brake and/or park mechanism to hold the vehicle in place during winching. Use wheel chocks if needed.
11. Always align the vehicle and winch with the load directly in front of the vehicle as much as possible. Avoid winching with the winch cable at an angle to the winching vehicle's centerline whenever possible.
12. If winching at an angle is unavoidable, follow these precautions:
 - A. Look at the winch drum occasionally. Never let the winch cable "stack" or accumulate at one end of the winch drum. Too much winch cable at one end of the winch drum can damage the winch and the winch cable.
 - B. If stacking occurs, stop winching. Follow step 15 on page 78 to feed and rewind the cable evenly before continuing the winch operation.
13. Never winch up or down at sharp angles. This can destabilize the winching vehicle and possibly cause it to move without warning.
14. Never attempt to winch loads that weigh more than the winch's rated capacity.
15. The winch motor may become hot during winch use. If you winch for more than 45 seconds, or if the winch stalls during operation, stop winching and permit the winch to cool down for 10 minutes before using it again.
16. Never touch, push, pull or straddle the winch cable while winching a load.
17. Never let the winch cable run through your hands, even if wearing heavy gloves.

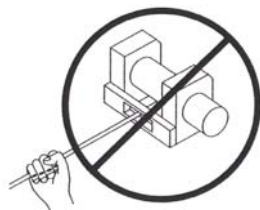

Winch Safety Precautions

18. Never release the clutch on the winch when the winch cable is under load.
19. Never use the winch for lifting or transporting people.
20. Never use the winch to hoist or suspend a vertical load.
21. Never immerse or submerge your winch in water. Your dealer can provide service on your winch if this occurs.
22. Always inspect your winch and winch cable before each use.
23. Never winch the hook fully into the winch. This can cause damage to winch components.
24. Unplug the remote control from the vehicle when the winch is not in use to prevent inadvertent activation and use by unauthorized persons.
25. Never grease or oil the winch cable. This will cause the winch cable to collect debris that will shorten the life of the cable.

WINCH GUIDE

Winch Operation

Read the *Winch Safety Precautions* in the preceding pages before using your winch.

Tip: Consider practicing the operation and use of your winch before you actually need to use it in the field.

⚠ WARNING

Improper winch use can result in SEVERE INJURY or DEATH. Always follow all winch instructions and warnings in this manual.

Each winching situation is unique.

- Take your time to think through the winching you are about to do.
 - Proceed slowly and deliberately.
 - Never hurry or rush during winching.
 - Always pay attention to your surroundings.
 - You may need to change your winching strategy if it is not working.
 - Always remember that your winch is very powerful.
 - There are simply some situations that you and your winch will not be able to deal with. Do not be afraid to ask others to help when this happens.
1. Always inspect the vehicle, winch, winch cable and winch controls for any signs of damage or parts in need of repair or replacement before each use. *Pay particular attention to the first 3 feet (1 meter) of winch cable if the winch is being used (or has been used) for lifting an accessory plow assembly.* Promptly replace any worn or damaged cable.
 2. Never operate a winch or a vehicle in need of repair or service.
 3. Always apply your vehicle's park brake and/or park mechanism to hold the vehicle in place during winching. Use wheel chocks if needed.

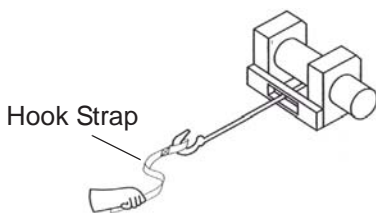

Winch Operation

4. Always use the hook strap when handling the hook.

WARNING! Never put your fingers into the hook. This could lead to SEVERE INJURY.

- A. Attach the hook itself onto the load or use a tow strap or chain to secure the load to the winch cable.



NO



YES

Tip: A “tow strap” is NOT intended to stretch. A “recovery strap” is designed to stretch.

WARNING! Never use a recovery strap when winching due to the excessive energy that can be released if the winch cable breaks. This can result in SEVERE INJURY or DEATH. See the *Shock Loading* section on page 80.

- B. Never hook the winch cable back onto itself. This will damage the winch cable and may result in winch cable failure.

WARNING! Replace the winch cable at the first sign of damage to prevent SEVERE INJURY or DEATH in the event of failure. For your safety, always replace POLARIS winch parts (including the cable) with genuine POLARIS replacement parts available at an authorized dealer.

- C. If possible, keep the winch cable aligned with the centerline of the winching vehicle. This will help the spooling of the winch cable and reduce the load on the fairlead.
- D. If freeing a stuck vehicle by attaching to a tree, use an item such as a tow strap to avoid damaging the tree during winch operation. Sharp cables and chains can damage and even kill trees. Please remember to TreadLightly® (treadlightly.org).
- E. Before operating the winch, be sure that the safety latch on the winch cable hook is fully seated when the load is attached.
- F. Never operate your winch with a damaged hook or latch. Always replace damaged parts before using the winch.



YES



NO

WINCH GUIDE

Winch Operation

5. Never remove the hook strap from the hook.
6. Release the winch clutch and pull out the winch cable.
7. Pulling out as much cable as possible maximizes the winch's pulling capacity. Always be sure that at least five (5) full turns of winch cable are wrapped around the winch drum at all times. The friction provided by this wrapped cable allows the drum to pull on the winch cable and move the load.
8. Read and adhere to the following information for winch damping to ensure safe winch use.
 - A. In order to absorb energy that could be released by a winch cable failure, always place a "damper" on the winch cable. A damper can be a heavy jacket, tarp, or other soft, dense object. A damper can absorb much of the energy released if a winch cable breaks when winching. Even a tree limb can help as a damper if no other items are available to you.
 - B. Lay the damper on top of the mid-point of the winch cable length that is spooled out.
 - C. On a long pull, it may be necessary to stop winching so that the damper can be repositioned to the new mid-point of the winch cable. Always release the tension on the winch cable before repositioning the damper.
 - D. Avoid being directly in line with the winch cable whenever possible. Also, never permit others to stand near or in line with the winch cable during winch operation.
9. Never hook the winch cable back onto itself. This will damage the winch cable and may result in winch cable failure.
10. Never use straps, chains or other rigging items that are damaged or worn.

Winch Operation

11. The **ONLY** time a winch-equipped vehicle should be moving when using the winch is when that vehicle itself is stuck. The winch-equipped vehicle should **NEVER** be in motion to “shock” load the winch cable in an attempt to move a second stuck vehicle. See the *Shock Loading* section on page 80. For your safety, always follow these guidelines when winching a vehicle free:
 - A. Release the winch clutch and spool out the necessary length of winch cable.
 - B. Align the winch cable as close as possible to the winching vehicle's centerline.
 - C. Attach the winch cable hook to the anchor point or the stuck vehicle's frame following instructions in this manual.
 - D. Re-engage the clutch on the winch.
 - E. Slowly winch in the slack in the winch cable.
 - F. Select the proper vehicle gear to propel the stuck vehicle in the direction of winching.
 - G. Shift to the lowest gear available on the stuck vehicle.
 - H. Slowly and carefully apply vehicle throttle and winch together to free the vehicle.
 - I. Stop winching as soon as the stuck vehicle is able to propel itself without the help of the winch.
 - J. Detach the winch cable hook.
 - K. Rewind the winch cable evenly back onto the winch drum following the instructions in this manual.
12. Never attempt to winch another stuck vehicle by attaching the winch cable to a suspension component, brush guard, bumper or cargo rack. Vehicle damage may result. Instead, attach the winch to a strong portion of the vehicle frame or hitch.
13. Extensive winching will run down the battery on the winching vehicle. Let the winching vehicle's engine run while operating the winch to prevent the battery from running low if winching for long periods.

WINCH GUIDE

Winch Operation

14. The winch motor may become hot during winch use. If you winch for more than 45 seconds, or if the winch stalls during operation, stop winching and permit the winch to cool down for 10 minutes before using it again.
15. After winching is complete, especially if winching at an angle, it may be necessary to re-distribute the winch cable across the winch drum. You will need an assistant to perform this task.
 - A. Release the clutch on the winch.
 - B. Feed out the winch cable that is unevenly bunched up in one area.
 - C. Re-engage the winch clutch.
 - D. Have an assistant pull the winch cable tightly with about 100 lbs. (45 kg) of tension using the hook strap.
 - E. Slowly winch the cable in while your assistant moves the end of the winch cable back and forth horizontally to evenly distribute the winch cable on the drum.
 - F. Doing this reduces the chances of the winch cable “wedging” itself between lower layers of winch cable.

Winch Cable Care

For your safety, always replace POLARIS winch parts (including the cable) with genuine POLARIS replacement parts available at an authorized dealer.

WARNING! Use of worn or damaged cable could lead to sudden failure and SEVERE INJURY.

1. Always inspect your winch before each use. Inspect for worn or loose parts including mounting hardware. Never use the winch if any part needs repair or replacement.
2. Always inspect your winch cable before each use. Inspect for worn or kinked winch cable.

A. A kinked winch cable made of wire rope is shown at right. Even after being “straightened out,” this cable has already been permanently and severely damaged. Promptly discontinue use of a winch cable in this condition.



B. A kinked winch cable made of wire rope that has been “straightened out” is shown at right. Even though it may look usable, the cable has been permanently and severely damaged. It can no longer transmit the load that it could prior to kinking. Promptly discontinue use of a winch cable in this condition.



C. A winch cable made of synthetic rope should be inspected for signs of fraying. Replace the cable if fraying is observed (shown at right). Promptly discontinue use of a winch cable in this condition.



D. Also replace the winch cable if there are fused or melted fibers. Such an area of the synthetic rope will be stiff and appear smooth or glazed. Promptly discontinue use of a winch cable in this condition.

WINCH GUIDE

Shock Loading

WARNING! Your winch cable is very strong but it is NOT designed for dynamic, or “shock” loading. Shock loading may tension a winch cable beyond its strength and cause the cable to break. The end of a broken winch cable under such high loading can cause SEVERE INJURY or DEATH to you and other bystanders.

Winch cables are designed to NOT absorb energy. This is true of both wire-rope and synthetic-rope winch cables.

1. Never attempt to “jerk” a load with the winch. For example, never take up slack in the winch cable by moving the winching vehicle in an attempt to move an object. This is a dangerous practice. It generates high winch cable loads that may exceed the strength of the cable. Even a slowly moving vehicle can create large shock loads in a winch cable.

WARNING! SEVERE INJURY or DEATH can result from a broken winch cable.

2. Never quickly turn the winch ON and OFF repeatedly (“jogging”). This puts extra load on the winch, winch cable, and generates excessive heat from the motor. This is a form of shock loading.
3. Never tow a vehicle or other object with your winch. Towing an object with a winch produces shock loading of the cable even when towing at slow speeds. Towing from a winch also positions the towing force high on the vehicle. This can cause instability of the vehicle and possibly lead to an accident.
4. Never use recovery straps with your winch. Recovery straps are designed to stretch and can store energy. This stored energy in the recovery strap is released if a winch cable fails making the event even more hazardous. Similarly, never use elastic “bungie” cords for winching.
5. Never use the winch to tie down a vehicle to a trailer or other transportation vehicle. This type of use also causes shock loading that can cause damage to the winch, winch cable, or vehicles used.

Your winch cable is designed and tested to withstand the loads produced by the winch motor when operated from a stationary vehicle. Always remember that the winch and winch cable are NOT designed for shock loading.

Winch Maintenance and Service Safety

WARNING! Improper or lack of winch maintenance and service could lead to SEVERE INJURY or DEATH. Always follow all winch instructions and warnings in this manual.

1. Always inspect your winch before each use. Inspect for worn or kinked winch cable. Also inspect for worn or loose parts including mounting hardware.
2. Permit your winch motor to cool down prior to servicing your winch.
3. Never work on your winch without first disconnecting the battery connections to prevent accidental activation of the winch.
4. For your safety, always replace POLARIS winch parts (including the cable) with genuine POLARIS replacement parts available at your authorized POLARIS dealer.
5. Some winch models use wire rope as the winch cable. Other winches use a specially designed synthetic rope as the winch cable.
6. Never replace a synthetic-rope winch cable with a consumer-grade polymer rope such as can be purchased in a hardware store. Although they may look similar, they are NOT alike. A polymer rope not designed for winch use will stretch and store excessive energy when winching.

WARNING! Failure of a stretched rope under winching conditions will release all of the stored energy. This will increase the chances of SEVERE INJURY or DEATH.

EMISSION CONTROL SYSTEMS

Noise Emission Control System

Do not modify the engine, intake or exhaust components, as doing so may affect compliance with U.S.A. EPA noise control requirements (40 CFR 205) and local noise level requirements.

Operation on Public Lands in the U.S.A.

Your POLARIS vehicle has a spark arrester that was tested and qualified to be in accordance with the USFS standard 5100-1C. Federal law requires that this spark arrester be installed and functional when the vehicle is operated on public lands.

Operation of off-road vehicles on public lands in the U.S.A. is regulated by 43 CFR 420. Violations are subject to monetary penalties. Federal regulations can be viewed online at www.gpoaccess.gov/ecfr/.

Crankcase Emission Control System

This engine is equipped with a closed crankcase system. Blow-by gases are forced back to the combustion chamber by the intake system. All exhaust gases exit through the exhaust system.

Exhaust Emission Control System

Exhaust emissions are controlled by engine design. An electronic fuel injection (EFI) system controls fuel delivery. The engine and EFI components are set at the factory for optimal performance and are not adjustable.

The emissions label is located on the left front frame tube of the vehicle.

Electromagnetic Interference

This spark ignition system complies with Canadian ICES-002.

This vehicle complies with the EMC requirements of European directives 97/24/EC and 2004/108/EC.

Non-ionizing Radiation: This vehicle emits some electromagnetic energy. People with active or non-active implantable medical devices (such as heart monitoring or controlling devices) should review the limitations of their device and the applicable electromagnetic standards and directives that apply to this vehicle.

Periodic Maintenance Chart

Any qualified repair shop or person may maintain, replace or repair the emission control devices or systems on your vehicle. An authorized POLARIS dealer can perform any service that may be necessary for your vehicle. POLARIS also recommends POLARIS parts for emissions-related service, however equivalent parts can be used.

It is a potential violation of the Clean Air Act if a part supplied by an aftermarket parts manufacturer reduces the effectiveness of the vehicle's emission controls. Tampering with emission controls is prohibited by federal law.

Owners are responsible for performing the scheduled maintenance identified in this owner's manual.

Careful periodic maintenance will help keep your vehicle in the safest, most reliable condition. Inspection, adjustment and lubrication of important components are explained in the periodic maintenance chart.

Inspect, clean, lubricate, adjust and replace parts as necessary. When inspection reveals the need for replacement parts, genuine POLARIS parts are available from your POLARIS dealer. Equivalent parts may be used for emissions-related service.

Service and adjustments are important for proper vehicle operation. If you're not familiar with safe service and adjustment procedures, a qualified dealer can perform these operations.

Vehicles subjected to heavy or severe use patterns must be inspected and serviced more frequently.

Severe Use Definition

- Frequent immersion in mud, water or sand
- Frequent or prolonged operation in dusty environments
- Racing or race-style high RPM use
- Prolonged low speed, heavy load operation
- Extended idle
- Short trip cold weather operation

Pay special attention to the oil level. A rise in oil level during cold weather can indicate contaminants collecting in the oil sump or crankcase. Change oil immediately if the oil level begins to rise. Monitor the oil level, and if it continues to rise, discontinue use and determine the cause. Your POLARIS dealer can assist.

MAINTENANCE

Periodic Maintenance Chart

Maintenance Chart Key

Symbol	Description
XU	Perform these operations more often for vehicles subjected to severe use.
D	Have an authorized POLARIS dealer or other qualified person perform these services.

WARNING! Improperly performing the procedures marked with a “D” could result in component failure and lead to serious injury or death. Have an authorized POLARIS dealer or other qualified person perform these services.

MAINTENANCE

Periodic Maintenance Chart

Perform all services at whichever maintenance interval is reached first. Record maintenance and service in the Maintenance Log beginning on page 143.

Item		Maintenance Interval (whichever comes first)			Remarks
		Hours	Calendar	Miles (Km)	
	Steering		Pre-Ride		Inspect and make adjustments as need ed. See Pre-Ride Checklist on page 54.
	Front suspension				
	Rear suspension				
	Tires				
	Brake fluid level				
	Brake pedal travel				
	Brake system				
	Wheels/fasteners				
	Frame fasteners				
	Engine oil level				
	Intake pre-filters				
	Coolant	-	Daily	-	Check level
XU	Power steering unit (if equipped)	-	Daily	-	Inspect daily; clean often
	Headlamp/tail lamp	-	Daily	-	Check operation; apply dielectric grease if replacing
XU	Air filter, main element	-	Weekly	-	Inspect; replace as needed
XU D	Brake pad wear	10 H	Monthly	100 (160)	Inspect periodically
XU	Engine breather	25 H	Monthly	150 (250)	Inspect; replace if necessary
	Fuel System	25 H	Monthly	150 (250)	Inspect; cycle key to pressurize fuel pump; check lines and fittings for leaks and abrasion
	Battery	25 H	Monthly	250 (400)	Check terminals; clean; test
XU	Engine oil change	25 H	1 M	-	Break-in oil and filter change
XU	Demand drive fluid	25 H	1 M	-	Break-in oil level check
XU	Transmission oil (main gearcase)	25 H	1 M	-	Break-in oil level check

XU Perform these procedures more often for vehicles subjected to severe use.

D Have an authorized POLARIS dealer or other qualified person perform these services.

MAINTENANCE

Periodic Maintenance Chart

Item		Maintenance Interval (whichever comes first)			Remarks
		Hours	Calendar	Miles (Km)	
	Throttle body air intake ducts/flange	50 H	6 M	300 (500)	Inspect duct for proper sealing/air leaks
XU	General lubrication	50 H	3 M	500 (800)	Lubricate all fittings, pivots, cables, etc.
XU	Oil lines, fasteners (if equipped)	50 H	6 M	500 (800)	Inspect for leaks and loose fittings
	Shift Linkage	50 H	6 M	500 (800)	Inspect, lubricate, adjust
D	Steering	50 H	6 M	500 (800)	Lubricate
XU	Front Suspension	50 H	6 M	500 (800)	Lubricate
XU	Rear Suspension	50 H	6 M	500 (800)	Lubricate
	Cooling system	50 H	6 M	500 (800)	Inspect coolant strength seasonally; pressure test system yearly
XU	Engine oil change	100 H	6 M	1000 (1600)	Change the oil and filter
D	Fuel system	100 H	12 M	600 (1000)	Cycle key to pressurize fuel pump; check for leaks at fill cap, fuel lines/rail and fuel pump; replace lines every two years
XU	Spark plug	100 H	12 M	600 (1000)	Inspect; replace as needed
XU	Demand drive fluid	100 H	12 M	-	Change fluid
XU	Transmission oil (main gearcase)	100 H	12 M	-	Change fluid

XU Perform these procedures more often for vehicles subjected to severe use.

D Have an authorized POLARIS dealer or other qualified person perform these services.

MAINTENANCE

Periodic Maintenance Chart

Item		Maintenance Interval (whichever comes first)			Remarks
		Hours	Calendar	Miles (Km)	
XU	Radiator	100 H	12 M	1000 (1600)	Inspect; clean external surfaces
XU	Cooling Hoses	100 H	12 M	1000 (1600)	Inspect for leaks
XU	Engine mounts	100 H	12 M	1000 (1600)	Inspect
	Exhaust muffler/ pipe	100 H	12 M	1000 (1600)	Inspect
XU	Wiring	100 H	12 M	1000 (1600)	Inspect for wear, routing, security; apply dielectric grease to connectors subjected to water, mud, etc.
D	Clutches (drive and driven)	100 H	12 M	1000 (1600)	Inspect; clean; replace worn parts
	Drive belt	100 H	12 M	1000 (1600)	Inspect; replace as needed
D	Front wheel bearings	100 H	12 M	1000 (1600)	Inspect; replace as needed
D	Brake fluid	200 H	24 M	2000 (3200)	Change every two years
	Suspension bushings	250 H	24 M	2000 (3200)	Inspect; replace if necessary
	Spark arrester	200 H	24 M	2000 (3200)	Clean daily when driving in mud and water; replace a cracked or damaged arrester before operating (see page 108)
XU	Coolant	-	60 M	-	Replace coolant
XU	Valve clearance	500 H	-	5000 (8000)	Inspect; adjust as needed
D	Toe adjustment	-			Inspect periodically; adjust when parts are replaced
	Headlight aim	-			Adjust as needed

UX Perform these procedures more often for vehicles subjected to severe use.

D Have an authorized POLARIS dealer or other qualified person perform these services.

MAINTENANCE

Lubrication Recommendations

Check and lubricate all components at the intervals outlined in the Periodic Maintenance Chart beginning on page 83, or more often under severe use, such as wet or dusty conditions. Items not listed in the chart should be lubricated at the general lubrication interval.

Item	Lube	Method
Engine Oil	PS-4 5W-50 4-Cycle Oil	Add to proper level on dipstick. See page 91.
Brake Fluid	DOT 4 Brake Fluid	Maintain level between fill lines. See page 110.
Transmission Oil (Main Gearcase)	AGL Gearcase Lubricant & Transmission Fluid	See page 95.
Demand Drive Fluid (Front Gearcase)	Demand Drive Fluid	See page 94.
Prop Shaft	U-Joint Grease	Locate fittings and grease.
Control Arm Pivot Bushings, Front/Rear	All Season Grease or grease conforming to NLGI No. 2	Locate fittings and grease.
Stabilizer Bar Bushings	All Season Grease or grease conforming to NLGI No. 2	Locate fittings and grease.

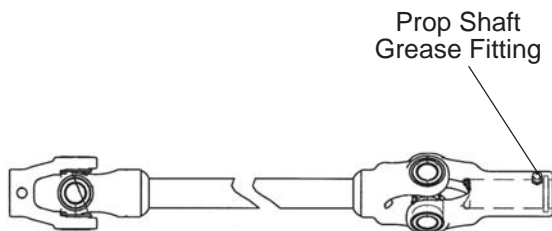

MAINTENANCE

Lubrication Recommendations

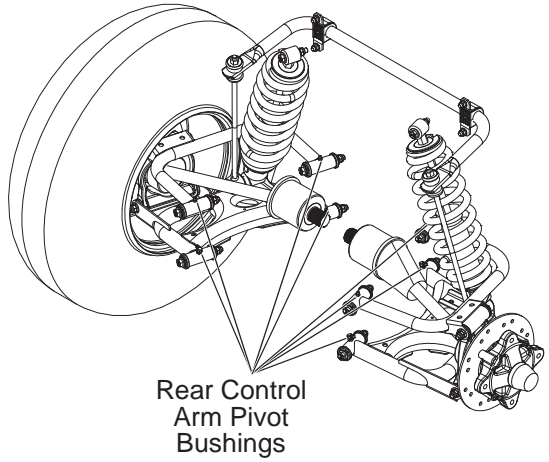

Front Stabilizer Bar Bushings

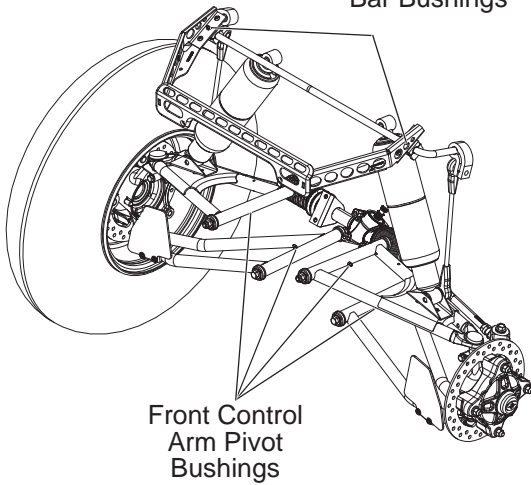

MAINTENANCE

Engine Oil

Oil Recommendations

POLARIS recommends the use of POLARIS PS-4 Full Synthetic 5W-50 4-cycle oil for this engine.

WARNING! Vehicle operation with insufficient, deteriorated, or contaminated engine oil will cause accelerated wear and may result in engine seizure, accident, and injury. Always perform the maintenance procedures as outlined in the Periodic Maintenance Chart.

Oil may need to be changed more frequently if POLARIS PS-4 engine oil is not used. Follow the manufacturer's recommendations for ambient temperature operation. See page 132 for the part numbers of POLARIS products.

NOTICE: Mixing brands or using a non-recommended oil may cause serious engine damage. Always use the recommended oil. Never substitute or mix oil brands.

Engine Oil

Always check and change the oil at the intervals outlined in the Periodic Maintenance Chart beginning on page 83. Always use the recommended engine oil.

NOTICE: Allowing dirt or debris to enter the engine can result in serious engine damage. Always clean away all dirt and debris from the dipstick area before removing the dipstick.

Oil Check

The oil dipstick and fill tube is located on the engine, behind the passenger seat. Access the dipstick through the right rear wheel well.

1. Position the vehicle on a level surface.
2. Place the transmission in PARK.
3. Always clean away all dirt and debris from the dipstick area before removing the dipstick. Remove the dipstick. Wipe it dry with a clean cloth.
4. Reinstall and tighten the dipstick.
5. Remove the dipstick and check the oil level.
6. Add the recommended fluid as needed. Maintain the oil level in the safe range between the FULL and ADD marks. Do not overfill.
7. Reinstall and tighten the dipstick.



Dipstick

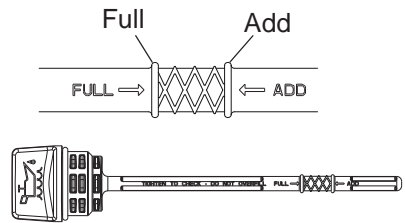

MAINTENANCE

Engine Oil

Oil and Filter Change

Always check and change the oil at the intervals outlined in the Periodic Maintenance Chart beginning on page 83. Always change the oil filter whenever changing oil.

The engine drain plug is located on the bottom of the crankcase.

1. Position the vehicle on a level surface. Place the transmission in PARK. Apply the brakes.
2. Start the engine. Allow it to idle for two to three minutes. Stop the engine.
3. Clean the area around the drain plug.

CAUTION! Hot oil can cause burns to skin. Do not allow hot oil to contact skin.

4. Place a drain pan beneath engine crankcase and remove the drain plug.
5. Allow the oil to drain completely.
6. Reinstall the sealing washer on the drain plug.

Tip: The sealing surfaces on drain plug and crankcase should be clean and free of burrs, nicks or scratches.

7. Reinstall the drain plug. Torque to 12 ft. lbs. (16 Nm).



Drain Plug Access

Engine Oil Oil and Filter Change

8. Using a cap-style oil filter wrench, turn the filter counter-clockwise to remove it.
9. Using a clean dry cloth, clean the filter sealing surface on the crankcase. Make sure the old filter o-ring is completely removed.
10. Lubricate the o-ring on the new filter with a film of fresh engine oil. Check to make sure the o-ring is in good condition.
11. Install the new filter and rotate it clockwise by hand until the filter gasket contacts the sealing surface, then turn it an additional $\frac{3}{4}$ turn.
12. Always clean away all dirt and debris from the dipstick area before removing the dipstick. Remove the dipstick and fill the sump with two quarts (1.9 l) of recommended oil.
13. Reinstall and tighten the dipstick.
14. Make sure the transmission is in PARK. Apply the brakes.
15. Start the engine. Allow it to idle for one to two minutes.
16. Stop the engine. Inspect for leaks.
17. Re-check the oil level on the dipstick and add oil as necessary to bring the level to the upper mark on the dipstick.
18. Dispose of used filter and oil properly.

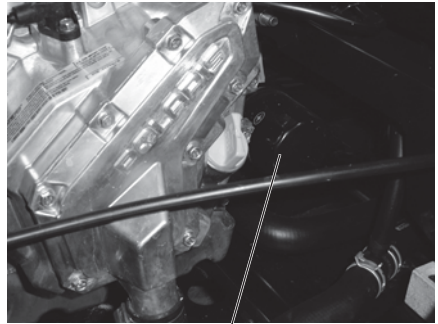

Oil Filter

MAINTENANCE

Gearcases

Demand Drive Unit (Front Gearcase)

Always check and change the fluid at the intervals outlined in the Periodic Maintenance Chart beginning on page 83. Refer to the Gearcase Specifications Chart on page 96 for recommended lubricants, capacities and torque specifications.

Fluid Check

The fill plug is located on the bottom right side of the demand drive unit. Maintain the fluid level even with the bottom thread of the fill plug hole.

1. Position the vehicle on a level surface.
2. Remove the fill plug. Check the fluid level.
3. Add the recommended fluid to the bottom thread of the fill plug hole.
4. Reinstall the fill plug. Torque to specification.

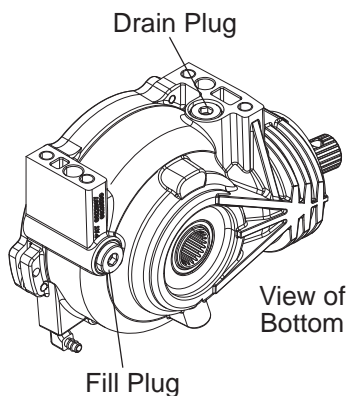

Fluid Change

The drain plug is located on the bottom of the gearcase.

1. Remove the fill plug.
2. Place a drain pan under the drain plug.
3. Remove the drain plug. Allow the fluid to drain completely.
4. Clean the drain plug. If the o-ring is damaged, install a new o-ring.
5. Reinstall the drain plug. Torque to specification.
6. Add the recommended fluid to the bottom thread of the fill plug hole.
7. Reinstall the fill plug. Torque to specification.
8. Check for leaks. Discard used fluid properly.

Gearcases

Transmission (Main Gearcase)

Always check and change the fluid at the intervals outlined in the Periodic Maintenance Chart beginning on page 83. Refer to the Gearcase Specifications Chart on page 96 for recommended lubricants, capacities and torque specifications.

Fluid Check

The fill plug is located on the rear of the gearcase. Maintain the fluid level at the bottom of the fill plug hole.

1. Position the vehicle on a level surface.
2. Remove the fill plug.
3. Check the fluid level.
4. Add the recommended fluid to the bottom of the fill plug hole. Do not overfill.
5. Reinstall the fill plug. Torque to specification.



Fill Plug

Fluid Change

The drain plug is located on the bottom of the gearcase. Access the drain plug through the drain hole in the skid plate.

1. Remove the fill plug.
2. Place a drain pan under the drain plug.
3. Remove the drain plug. Allow the fluid to drain completely.
4. Clean the drain plug.
5. Reinstall the drain plug. Torque to specification.
6. Add the recommended fluid to the bottom of the fill plug hole. Do not overfill.
7. Reinstall the fill plug. Torque to specification.
8. Check for leaks. Discard used fluid properly.

MAINTENANCE

Gearcases

Gearcase Specification Chart

Use of other fluids may result in improper operation of components. See page 132 for the part numbers of POLARIS products.

Gearcase	Lubricant	Capacity	Fill Plug Torque	Drain Plug/Level Check Plug Torque
Transmission (Main Gearcase)	AGL Gearcase Lubricant & Transmission Fluid	Standard Models 44 oz. (1300 ml) LE/INTL Models 41 oz. (1200 ml)	10-14 ft. lbs. (14-19 Nm)	10-14 ft. lbs. (14-19 Nm)
Demand Drive Unit (Front Gearcase)	Demand Drive Fluid	6.75 oz. (200 ml)	8-10 ft. lbs. (11-13.6 Nm)	11 ft. lbs. (15 Nm)

Spark Plug

Spark Plug Gap/Torque

Electrode Gap	New Plug Torque	Used Plug Torque
0.7-0.8 mm	7.5 ft. lbs. (10 Nm)	7.5 ft. lbs. (10 Nm)

NOTICE: Using non-recommended spark plugs can result in serious engine damage. Always use POLARIS-recommended spark plugs or their equivalent. Refer to the specifications section beginning on page 130.

Spark plug condition is indicative of engine operation. The spark plug firing end condition should be read after the engine is warmed up and the vehicle is driven at higher speeds. Immediately check the spark plug for correct color. See page 97.

CAUTION! A hot exhaust system and engine can cause burns. Wear protective gloves when removing a spark plug for inspection.

Spark Plug

Spark Plug Removal and Replacement

1. Remove the rear access panel in the cargo box.
2. Remove the spark plug cap.
3. Using the spark plug wrench provided in the tool kit, remove the plug by rotating it counter-clockwise.
4. Reverse the procedure for spark plug installation. Torque to specification. See page 96.

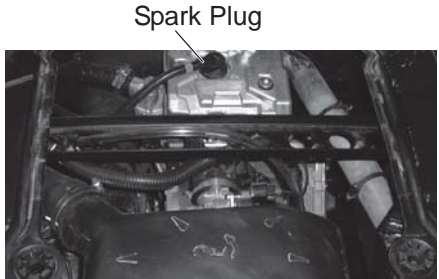

Spark Plug Condition

Normal Plug

The normal insulator tip is gray, tan or light brown. There will be few combustion deposits. The electrodes are not burned or eroded. This indicates the proper type and heat range for the engine and the service.

Wet Fouled Plug

The wet fouled insulator tip is black. A damp oil film covers the firing end. There may be a carbon layer over the entire nose. Generally, the electrodes are not worn. General causes of fouling are excessive oil, use of non-recommended injection oil or incorrect throttle body adjustments.

MAINTENANCE

Fuses

If the engine stops or will not start, if the power steering stops working (if equipped), or if you experience other electrical failures, a fuse may need replacement. Locate and correct any short circuits that may have caused the blown fuse, then replace the fuse.

Main Fuse	Feature Supported
20A	Lights: Headlights, Taillights
10A	Drive: AWD
20A	Accessory: Winch Switch, 12V Power Receptacle
10A	Fuel Pump
20A	Electronic Engine Control, Starting
Power Fuse	Feature Supported
30A	Engine Control
30A	Lights, Drive, Accessories
30A	Power Steering (if equipped)

The main fuse box is located under the dash, above the brake and throttle pedals. Spare fuses are provided in the fuse box.

The power fuse box is located under the driver's seat. Remove the engine access panel to access the fuse box.



Main Fuse Box



Power Fuse Box

Fuses

Main Fuse Box

1. From the left side of the vehicle, reach in and lift up on the two fuse box tabs.
2. Slide the fuse box slightly toward the right side of the vehicle to disengage it from the mount.
3. Remove the fuse box cover.
4. Remove the suspect fuse from the fuse panel. If the fuse is blown, install a new fuse with the same amperage rating.

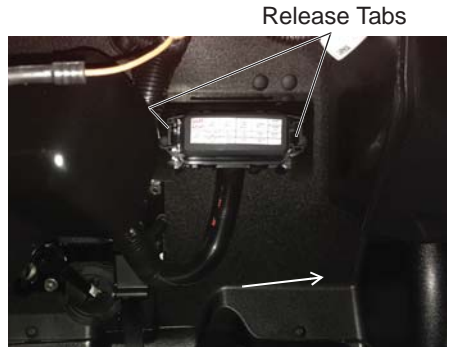

Slide right to disengage

5. Reinstall the fuse box cover. Reinstall the fuse box over the mount and slide it toward the left to engage the tabs. Be sure the fuse box is securely mounted.

MAINTENANCE

Cooling System

Operation

The engine coolant level is controlled or maintained by the recovery system. The recovery system components are the overflow bottle, radiator filler neck, radiator pressure cap and connecting hose.

As coolant operating temperature increases, the expanding (heated) excess coolant is forced out of the radiator, past the pressure cap, and into the overflow bottle. As engine coolant temperature decreases, the contracting (cooled) coolant is drawn back up from the tank, past the pressure cap, and into the radiator.

Tip: Some coolant level drop on new vehicles is normal as the system is purging itself of trapped air. Observe coolant levels and maintain as recommended by adding coolant to the overflow bottle.

Adding or Changing Coolant

POLARIS recommends the use of POLARIS Antifreeze 50/50 Premix. This antifreeze is already premixed and ready to use. Do not dilute with water. See page 132 for the part numbers of POLARIS products.

To ensure that the coolant maintains its ability to protect the engine, we recommend that the system be completely drained every five (5) years and fresh Antifreeze 50/50 Premix added.

Any time the cooling system has been drained for maintenance or repair, replace the coolant with fresh Antifreeze 50/50 Premix.

Cooling System

Radiator and Cooling Fan

Always check and clean the screen and radiator fins at the intervals outlined in the Periodic Maintenance Chart beginning on page 83. Do not obstruct or deflect air flow through the radiator by installing unauthorized accessories in front of the radiator or behind the cooling fan. Interference with the radiator air flow can lead to overheating and consequent engine damage.

NOTICE: Washing the vehicle with a high-pressure hose could damage the radiator fins and impair the radiator's effectiveness. Using a high-pressure system is not recommended.

Radiator Coolant Level

This procedure is required only if the cooling system has been drained for maintenance and/or repair. But if the overflow bottle has run dry, the level in the radiator should also be inspected.

CAUTION! Escaping steam can cause burns. Never remove the pressure cap while the engine is warm or hot. Always allow the engine to cool before removing the pressure cap.

1. Remove the hood. See page 27.
2. Slowly remove the radiator cap.
3. View the coolant level through the opening.
4. Use a funnel and slowly add coolant as needed.

Tip: Use of a non-standard pressure cap will not allow the recovery system to function properly. Your POLARIS dealer can provide the correct replacement part.

MAINTENANCE

Cooling System

Coolant Level

Always check and change the coolant at the intervals outlined in the Periodic Maintenance Chart beginning on page 83. Maintain the coolant level between the minimum and maximum marks on the bottle (when the fluid is cool).

LE Model Shown

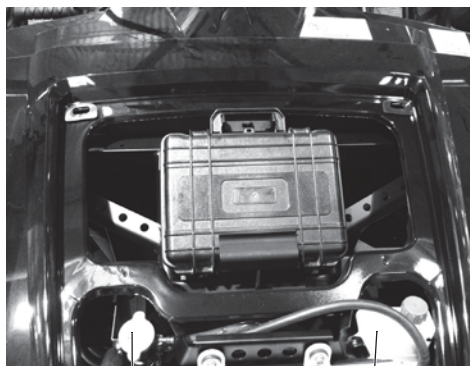

Radiator
Cap

Overflow
Bottle

1. Position the vehicle on a level surface.
2. Remove the hood. See page 27.
3. View the coolant level in the overflow bottle.
4. If the coolant level is below the safe operating range, remove the cap and use a funnel to add coolant through the opening. Reinstall the cap.

Tip: If coolant must be added often, or if the overflow bottle runs completely dry, there may be a leak in the system. Your POLARIS dealer can inspect the cooling system.

MAINTENANCE

POLARIS Variable Transmission (PVT) System

WARNING

Failure to comply with the instructions in this warning can result in severe injury or death.

Do not modify any component of the PVT system. Doing so may reduce its strength so that a failure may occur at a high speed. The PVT system has been precision balanced. Any modification will cause the system to be out of balance, creating vibration and additional loads on components.

The PVT system rotates at high speeds, creating large amounts of force on clutch components. As the owner, you have the following responsibilities for your own safety and the safety of others:

- Always follow all recommended maintenance procedures. Always look for and remove debris inside and around the clutch and vent system when replacing the belt.
- See your POLARIS dealer or other qualified service person as outlined in the owner's manual.
- This PVT system is intended for use on POLARIS products only. Do not install it in any other product.
- Always make sure the PVT housing is securely in place during operation.

Belt slip is responsible for creating excessive heat that destroys belts, wears clutch components and causes outer clutch covers to fail. Switch to low range while operating at slower speeds to extend the life of the PVT components (belt, cover, etc.).

MAINTENANCE

POLARIS Variable Transmission (PVT) System Belt Replacement/Debris Removal

If a belt fails, always clean any debris from the PVT intake and outlet duct and from the clutch and engine compartments when replacing the belt.

WARNING! Failure to remove ALL debris when replacing the belt could result in vehicle damage, loss of control and severe injury or death.

1. Allow hot components to cool before performing this procedure.
2. Remove the clutch cover screws and open the clutch cover. Remove all debris wrapped in and around the PVT system.
3. Remove all debris from the entire clutch air duct passage.
4. Check for signs of damage to seals on the transmission and engine. If any seals appear to be damaged, your vehicle requires prompt service. Your POLARIS dealer can assist.

Tip: Belt slip is responsible for creating excessive heat that destroys belts, wears clutch components and causes outer clutch covers to fail. Switch to low range while operating at slower speeds to extend the life of the PVT components (belt, cover, etc.).

MAINTENANCE

POLARIS Variable Transmission (PVT) System PVT Drying

There may be some instances when water is accidentally ingested into the PVT system. Use the following instructions to dry it out before operating.

NOTICE: When washing the vehicle, always avoid spraying water directly toward the PVT intake duct. See page 124 for recommended washing procedures.

1. Remove the drain plug from the bottom of the clutch box. Allow the water to drain. Reinstall the drain plug securely.
2. Place the transmission in PARK. Apply the brakes. Start the engine.
3. Apply varying throttle for 10-15 seconds to expel the moisture and air-dry the belt and clutches. Do not hold the throttle wide open for more than 10 seconds.
4. Allow the engine RPM to settle to idle speed. Apply the brakes. Shift the transmission to the lowest available range.
5. Test for belt slippage. If the belt slips, repeat the process.
6. Your vehicle requires service as soon as possible. Your POLARIS dealer can assist.

MAINTENANCE

Air Filter

Always clean all dirt and debris away from the air box area before servicing the air filter. Always change the air filter at the intervals outlined in the Periodic Maintenance Chart beginning on page 83.

1. Remove the rear access panel in the cargo box.
2. Clean all dirt and debris from the air box area.
3. Loosen the hose clamp and remove the intake hose from the air box cover before unlatching the cover clips.
4. Unlatch the cover clips and carefully remove the air box cover. Do not allow the air box cover to contact the air filter during removal.

NOTICE: Dirt or debris in the air box could result in severe engine damage. Always clean all dirt and debris from the air box before installing the filter.

5. Inspect the air box for dirt, debris, oil or water. Clean the air box thoroughly and wipe it well with a clean, dry cloth.

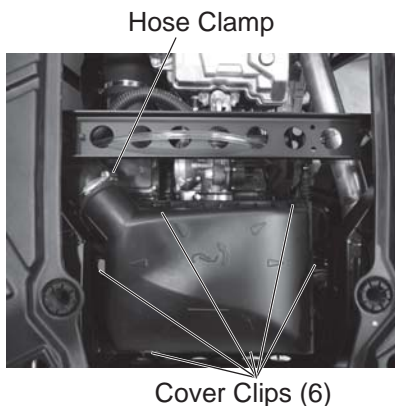

Air Filter

6. Install a new filter if needed. Do not attempt to clean the air filter. Install the air filter with the pleats facing upward.
7. Reinstall the air box cover and secure the cover clips. Do not allow the air box cover to contact the air filter during installation.
8. Reinstall the intake hose and tighten the clamp securely.
9. Reinstall the access panel.

Intake Pre-Filters

The engine and PVT intake pre-filters are located on the left side of the cargo box. Inspect both pre-filters before each use of the vehicle to ensure adequate air flow. If necessary, remove the pre-filters and clean with soapy water. Dry with low pressure compressed air.

NOTICE: When washing the vehicle, always avoid spraying water directly toward the PVT intake duct. See page 124 for recommended washing procedures.

Engine Intake Pre-Filter



PVT Intake Pre-Filter

MAINTENANCE

Spark Arrester

⚠ WARNING

Failure to heed the following warnings while servicing the spark arrester could result in serious injury or death.

- Do not perform clean-out immediately after the engine has been run, as the exhaust system becomes very hot. Serious burns could result from contact with the exhaust components. Allow components to cool sufficiently before proceeding.
- Wear eye protection and gloves.
- Never operate without the spark arrester.
- Never run the engine in an enclosed area. Exhaust contains poisonous carbon monoxide gas that can cause loss of consciousness or death in a very short time.

Periodically clean the spark arrester to remove accumulated carbon.

1. Remove the retaining nut. Remove the arrester from the end of the muffler.
2. Use a non-synthetic brush to clean the arrester screen. A synthetic brush may melt if components are warm. If necessary, blow debris from the screen with compressed air.
3. Inspect the screen for wear and damage. Replace a worn or damaged screen.
4. Reinstall the arrester. Torque the nut to 7-9 ft. lbs. (10-12 Nm).

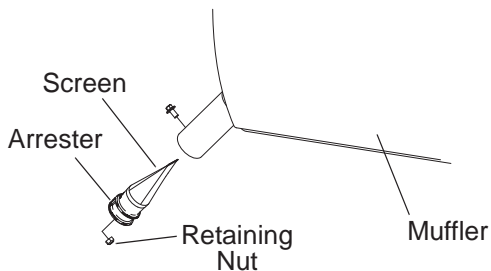

Brakes

The front and rear brakes are hydraulic disc type brakes activated by the brake pedal. See page 36.

Always check brake pedal travel and the brake fluid reservoir level before each use of the vehicle. When applied, the brake pedal should feel firm. Any sponginess would indicate a possible fluid leak or low brake fluid level, which must be corrected before riding. See page 110 for brake fluid information.

If you discover any irregularities in brake system operation, including excessive pedal travel, contact your POLARIS dealer or other qualified personnel for proper diagnosis and repairs.

WARNING! Operating the vehicle with a spongy brake pedal can result in loss of braking, which could cause an accident resulting in severe injury or death. Never operate the vehicle with a spongy-feeling brake pedal.

MAINTENANCE

Brakes

Brake Fluid

Inspect the level of the brake fluid before each operation. If the fluid level is low add DOT 4 brake fluid only. See page 132 for the part numbers of POLARIS products.

WARNING! After opening a bottle of brake fluid, always discard any unused portion. Never store or use a partial bottle. Brake fluid is hygroscopic, meaning it rapidly absorbs moisture from the air. The moisture causes the boiling temperature of the brake fluid to drop, which can lead to early brake fade and the possibility of accident or severe injury.

Change the brake fluid every two years and any time the fluid becomes contaminated, the fluid level is below the minimum, or if the type and brand of the fluid in the reservoir are unknown.

Access the brake fluid reservoir through the left front wheel well.

1. Position the vehicle on a level surface.
2. Place the transmission in **PARK**.
3. View the brake fluid level in the reservoir. The level should be between the maximum and minimum level lines.
4. If the fluid level is lower than the lower level line, add brake fluid to the upper line.
5. Apply the brake forcefully for a few seconds and check for fluid leakage around the fittings.



Brakes

Brake Inspection

1. Check the brake system for fluid leaks.
2. Check the brake pedal for excessive travel or a spongy feel.
3. Check the friction pads for wear, damage and looseness.
4. Check brake discs for signs of cracks, excessive corrosion, warping or other damage. Clean any grease using an approved brake cleaner or alcohol.

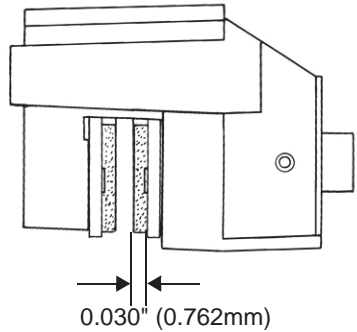

WARNING! Do not apply WD-40 or any petroleum product to brake discs. These types of products are flammable and may also reduce the friction between the brake pad and caliper.

5. Inspect the brake disc spline and pad wear surface for excessive wear. Change pads when worn to 0.030" (0.762 mm).

Steering Wheel Inspection

Check the steering wheel for specified freeplay and smooth operation at the intervals outlined in the Periodic Maintenance Chart beginning on page 83.

1. Position the vehicle on level ground.
2. Lightly turn the steering wheel left and right.
3. There should be 0.8"-1.0" (20-25 mm) of freeplay.
4. If there is excessive freeplay or strange noises, or the steering feels rough or "catchy," have the steering system inspected by an authorized POLARIS dealer or other qualified personnel.

MAINTENANCE

Suspension Settings

The front and rear suspensions are preload adjustable, with five settings on each axle.

The suspensions are set on the lowest (softest) setting at the factory. This setting is appropriate for nearly all riding conditions. Since the vehicle is equipped with full skid plates, suspension adjustment is not necessary.

If desired, the suspension may be adjusted to maintain vehicle clearance height when carrying loads. Your POLARIS dealer can provide the tool required to make suspension adjustments. Elevate the vehicle slightly for easier adjustment.

Always heed the following rules if you make adjustments to this suspension.

- Always return the suspension to the lowest (softest) setting after the load is removed from the vehicle. The increased suspension height will negatively impact vehicle stability when operating without a load.
- Always apply the same adjustment setting to *all four wheels*.
- Never operate the vehicle on the highest (stiffest) or second highest preload settings without a total combined payload in the vehicle of 450 lbs. (204 kg) or more. Payload includes the driver, passenger, POLARIS-approved accessories and cargo. Never exceed the stated load capacity for this vehicle. See page 130.

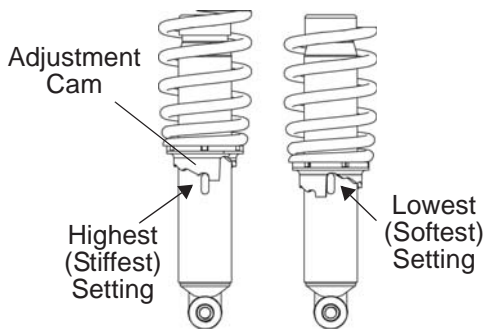

Tires

⚠ WARNING

Operating your vehicle with worn tires will increase the possibility of skidding, loss of control and an accident, which could result in serious injury or death. Always replace tires when the tread depth measures 1/8" (3 mm) or less.

Improper tire inflation or the use of non-standard size or type of tires may adversely affect vehicle handling, which could result in vehicle damage or personal injury. Always maintain proper tire pressure.. Always use POLARIS-approved size and type of tires for this vehicle when replacing tires.

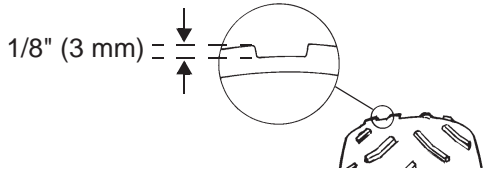

Tire Tread Depth

Always replace tires when tread depth is worn to 1/8" (3 mm) or less.



Axle and Wheel Nut Torque Specifications

Inspect the following items occasionally for tightness, and if they've been loosened for maintenance service. *Do not lubricate the stud or the lug nut.*

Lug Nut (Aluminum Wheels)		Front and Rear	30 ft. lbs. (41 Nm) PLUS 1/4 TURN or 90 degrees
2-Piece Flange Nut (Steel Wheels)		Front and Rear	27 ft. lbs. (37 Nm)
Hub Retaining Nut		Front and Rear	80 ft. lbs. (108 Nm)

MAINTENANCE

Tires

Wheel Removal

1. Position the vehicle on a level surface.
2. Place the transmission in PARK. Stop the engine.
3. Loosen the wheel nuts slightly.
4. Elevate the side of the vehicle by placing a suitable stand under the frame.
5. Remove the wheel nuts and washers. Remove the wheel.

Wheel Installation

1. Place the transmission in PARK.
2. Place the wheel in the correct position on the wheel hub. Be sure the valve stem is toward the outside and rotation arrows on the tire point toward forward rotation.

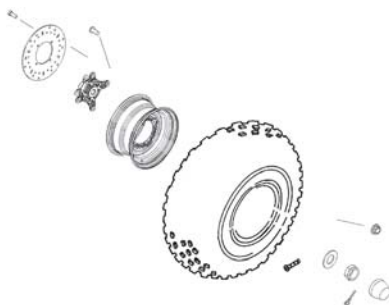

WARNING! Improperly installed wheels can adversely affect tire wear and vehicle handling, which can result in serious injury or death. Always ensure that all nuts are torqued to specification. Do not service axle nuts that have a cotter pin installed. Your POLARIS dealer can assist.

3. Attach the wheel nuts and washers and finger tighten.
4. Carefully lower the vehicle to the ground.
5. Torque the wheel nuts to specification. See page 113.

Lights

Headlight and taillight lenses become dirty during normal operation. Clean all lights frequently to ensure a clear field of vision as well as visibility to other vehicles.

When servicing a halogen lamp, don't touch the lamp with bare fingers. Oil from your skin leaves a residue, causing a hot spot that will shorten the life of the lamp.

LED Headlamps (if equipped)

If a headlight becomes damaged or inoperable, the entire headlight assembly must be replaced.

Tip: If an LED headlamp has moisture or fogging inside, disconnect the wiring harness from the headlamp(s) for a few days to allow the moisture to clear out. Do not operate the vehicle at night or in low light conditions without properly working headlights.

Headlight Lamp Replacement

Do not service the headlamps until they've cooled sufficiently.

1. Unplug the headlamp from the wiring harness. Be sure to pull on the connector, not on the wiring.
2. Turn the lamp counter-clockwise to remove it.
3. Install the new lamp. Make sure the tab on the lamp locates properly in the housing.
4. Reinstall the harness assembly into the headlight assembly.

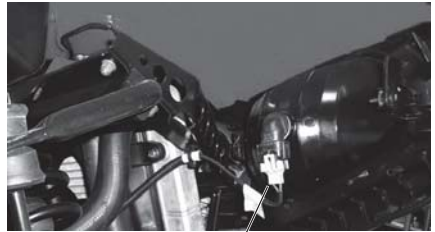

Wiring Harness

MAINTENANCE

Lights

Headlight Beam Adjustment

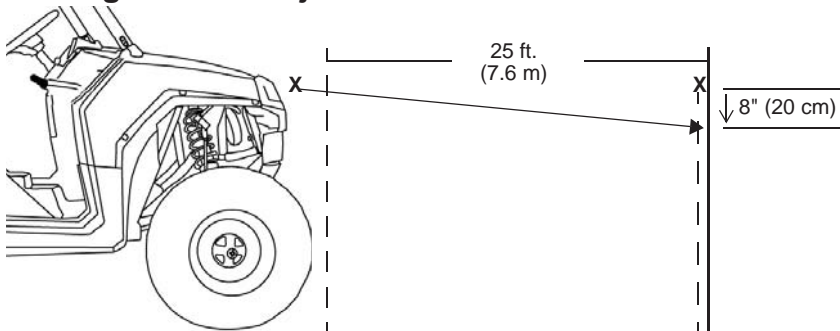

1. Place the vehicle on a level surface with the headlight approximately 25 ft. (7.6 m) from a wall. Place the transmission in PARK.
2. Measure the distance from the floor to the center of the headlight and make a mark on the wall at the same height.
3. Apply the brakes. Turn the ignition switch to the LIGHTS ON position.
4. Observe the headlight aim. The most intense part of the headlight beam should be aimed 8" (20 cm) below the mark placed on the wall in step 2. Include the weight of a rider on the seat while performing this step.
5. If adjustment is necessary, turn the headlight adjustment screw to adjust the beam.
6. Repeat steps 4-5 until the beam is properly adjusted.

Lights

Brake Lights

When the brake pedal is depressed, the brake light comes on. Check the brake light before each ride.

1. Turn the ignition switch to the LIGHTS ON position.
2. Apply the brakes. The brake light should come on after about 10 mm (0.4 in.) of pedal travel. If the light doesn't come on, check the bulb.

Vehicle Immersion

NOTICE: If your vehicle becomes immersed, major engine damage can result if the machine is not thoroughly inspected. Take the vehicle in for service before starting the engine. Your POLARIS dealer can provide this service.

If it's impossible to take your vehicle to a dealer before starting it, follow the steps outlined below.

1. Move the vehicle to dry land.
2. Check the air box. If water is present, dry the air box and replace the filter with a new filter. Thoroughly dry the air pre-filter. See pages 106-107.
3. Remove the spark plug.
4. Turn the engine over several times.
5. Dry the spark plug and reinstall it, or install a new plug.
6. Attempt to start the engine. If necessary, repeat the drying procedure.
7. Take the vehicle in for service as soon as possible, whether you succeed in starting it or not. Your POLARIS dealer can provide the required service.
8. If water has been ingested into the PVT follow the procedure on page 105 for drying.

MAINTENANCE

Battery

WARNING

Battery electrolyte is poisonous. It contains sulfuric acid. Serious burns can result from contact with skin, eyes or clothing.

Antidote:

External: Flush with water.

Internal: Drink large quantities of water or milk. Follow with milk of magnesia, beaten egg, or vegetable oil. Call physician immediately.

Eyes: Flush with water for 15 minutes and get prompt medical attention.

Batteries produce explosive gases. Keep sparks, flame, cigarettes, etc. away. Ventilate when charging or using in an enclosed space. Always shield eyes when working near batteries. KEEP OUT OF REACH OF CHILDREN.

Your vehicle may have either a sealed battery, which requires little maintenance, or a conventional battery. A sealed battery can be identified by its flat covers on the top of the battery. A conventional battery has six filler caps on the top of the battery.

Always keep battery terminals and connections free of corrosion. If cleaning is necessary, remove the corrosion with a stiff wire brush. Wash with a solution of one tablespoon baking soda and one cup water. Rinse well with tap water and dry off with clean shop towels. Coat the terminals with dielectric grease or petroleum jelly. Be careful not to allow cleaning solution or tap water into a conventional battery.

Battery

⚠ WARNING

Improperly connecting or disconnecting battery cables can result in an explosion and cause serious injury or death. When removing the battery, always disconnect the negative (black) cable first. When reinstalling the battery, always connect the negative (black) cable last.

Battery Removal

1. Remove the driver's seat. See page 28.
2. On conventional batteries, remove the battery vent tube.
3. Disconnect the black (negative) battery cable first.
4. Disconnect the red (positive) battery cable last.
5. Lift the battery out of the vehicle. Be careful not to tip a conventional battery sideways, which could spill electrolyte.



NOTICE: If electrolyte spills, immediately wash it off with a solution of one tablespoon baking soda and one cup water to prevent damage to the vehicle.

MAINTENANCE

Battery

Battery Installation

Using a new battery that has not been fully charged can damage the battery and result in a shorter life. It can also hinder vehicle performance. Follow the battery charging instructions on page 122 before installing the battery.

An optional extreme use battery may be available for your model. If the performance of the factory-installed battery is inadequate due to operation in extreme cold or due to extended use of multiple electrical accessories, please see your POLARIS dealer or other qualified personnel. Ask your dealer to provide any installation procedures that may differ for an extreme use battery.

1. Ensure that the battery is fully charged.
2. Place the battery in the battery holder.
3. On conventional batteries, install the battery vent tube (sealed batteries do not have a vent tube). The vent tube must be free of obstructions and securely installed. Route the tube away from the frame and vehicle body to prevent contact with electrolyte.

WARNING! Battery gases could accumulate in an improperly installed vent tube and cause an explosion, resulting in serious injury or death. Always ensure that the vent tube is free of obstructions and is securely installed as recommended.

4. Coat the terminals with dielectric grease or petroleum jelly.
5. Connect and tighten the red (positive) cable first.
6. Connect and tighten the black (negative) cable last.
7. Verify that cables are properly routed.
8. Reinstall the driver's seat.

Battery

Battery Storage

Whenever the vehicle is not used for a period of three months or more, remove the battery from the vehicle, ensure that it's fully charged, and store it out of the sun in a cool, dry place. Check battery voltage each month during storage and recharge as needed to maintain a full charge. See page 122.

Tip: Battery charge can be maintained by using a POLARIS Battery Tender charger or by charging about once a month to make up for normal self-discharge. Battery Tender can be left connected during the storage period, and will automatically charge the battery if the voltage drops below a pre-determined point. See page 132 for the part numbers of POLARIS products.

Battery Fluid (Conventional Battery)

A poorly maintained battery will deteriorate rapidly. Check the battery fluid level often. Maintain the fluid level between the upper and lower level marks.

Add only distilled water. Tap water contains minerals that are harmful to a battery.

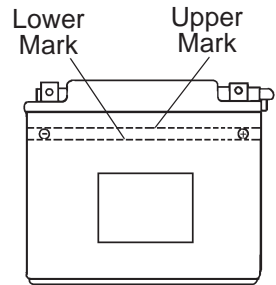

MAINTENANCE

Battery

Battery Charging (Conventional Battery)

1. Remove the battery from the vehicle to prevent damage from leaking or spilled electrolyte during charging. See page 119.
2. Charge the battery with a charging output no larger than 1/10 of the battery's amp/hr rating. Charge as needed to raise the specific gravity to 1.270 or greater.
3. Reinstall the battery. See page 120. Make sure the positive terminal is toward the front of the vehicle.

Battery Charging (Sealed Battery)

The following battery charging instructions apply only to the installation of a sealed battery. Read all instructions before proceeding with the installation of this battery.

The sealed battery is already filled with electrolyte and has been sealed and *fully charged* at the factory. *Never* pry the sealing strip off or add any other fluid to this battery.

The single most important thing about maintaining a sealed battery is to keep it fully charged. Since the battery is sealed and the sealing strip cannot be removed, you must use a voltmeter or multimeter to measure DC voltage.

WARNING! An overheated battery may explode, causing severe injury or death. Always watch charging times carefully. Stop charging if the battery becomes very warm to the touch. Allow it to cool before resuming charging.

For a refresh charge, follow all instructions carefully.

1. Check the battery voltage with a voltmeter or multimeter. A fully charged battery will register 12.8 V or higher.
2. If the voltage is less than 12.8 volts, recharge the battery at 1.2 amps or less until battery voltage is 12.8 or greater.

Tip: When using an automatic charger, refer to the charger manufacturer's instructions for recharging. When using a constant current charger, use the guidelines on the next page for recharging.

Battery

Battery Charging (Sealed Battery)

Always verify battery condition before and 1-2 hours after the end of charging.

State of Charge	Voltage	Action	Charge Time (Using constant current charger @ standard amps specified on top of battery)
100%	12.8-13.0 volts	None, check at 3 mos. from date of manufacture	None required
75%-100%	12.5-12.8 volts	May need slight charge, if no charge given, check in 3 months	3-6 hours
50%-75%	12.0-12.5 volts	Needs charge	5-11 hours
25%-50%	11.5-12.0 volts	Needs charge	At least 13 hours, verify state of charge
0%-25%	11.5 volts or less	Needs charge with desulfating charger	At least 20 hours

MAINTENANCE

Cleaning and Storage

Washing the Vehicle

Keeping your POLARIS vehicle clean will not only improve its appearance but it can also extend the life of various components.

NOTICE: High water pressure may damage components. POLARIS recommends washing the vehicle by hand or with a garden hose, using mild soap.

Certain products, including insect repellents and chemicals, will damage plastic surfaces. Do not allow these types of products to contact the vehicle.

The best and safest way to clean your POLARIS vehicle is with a garden hose and a pail of mild soap and water.

1. Use a professional-type washing cloth, cleaning the upper body first and the lower parts last.
2. Rinse with clean water frequently.
3. Dry surfaces with a chamois to prevent water spots.

Washing Tips

- Avoid the use of harsh cleaners, which can scratch the finish.
- Do not use a power washer to clean the vehicle.
- Do not use medium to heavy duty compounds on the finish.
- Always use clean cloths and pads for cleaning and polishing. Old or reused cloths and pads may contain dirt particles that will scratch the finish.

Cleaning and Storage

Washing the Vehicle

If a high pressure water system is used for cleaning (not recommended), exercise extreme caution. The water may damage components and could remove paint and labels. Avoid directing the water stream at the following items:

- Wheel bearings
- Radiator
- Transmission seals
- Brakes
- Cab and body panels
- Labels and decals
- Electrical components and wiring

If warning and safety labels are damaged, contact your POLARIS dealer for free replacement.

Grease all zerk fittings immediately after washing. Allow the engine to run for a while to evaporate any water that may have entered the engine or exhaust system.

Polishing the Vehicle

POLARIS recommends the use of common household aerosol furniture polish for polishing the finish on your POLARIS vehicle. Follow the instructions on the container.

Polishing Tips

- Avoid the use of automotive products, some of which can scratch the finish of your vehicle.
- Always use clean cloths and pads for cleaning and polishing. Old or reused cloths and pads may contain dirt particles that will scratch the finish.

MAINTENANCE

Cleaning and Storage

Chrome Wheel Care (if equipped)

Proper maintenance will protect chrome wheels from corrosion, preserve wheel life and ensure a “like new” appearance for many years.

Tip: Chrome wheels exposed to road salt (or salt in the air in coastal areas) are more susceptible to corrosion if not properly cleaned. Clean chrome wheels more often if they're exposed to salt or other corrosive elements.

1. Wash chrome wheels frequently. Use a mild detergent. Never use abrasive cleaners on plated or painted surfaces.
2. Rinse well with clear water. Soap, detergents, salt, dirt, mud and other elements can cause corrosion.
3. Polish the clean chrome wheels periodically. Use an automotive grade chrome polish.
4. Routinely and liberally apply a weather resistant wax to each polished chrome wheel. Choose a product suitable for chrome finishes. Read and follow the product labels and instructions.

Removing Corrosion

If light rust is found on the chrome finish, use steel wool (#0000-OTT grade) to remove it. Gently rub the affected areas with the steel wool until the corrosion has been removed. Clean and polish the wheel as outlined above.

Cleaning and Storage

Storage Tips

NOTICE: Starting the engine during the storage period will disturb the protective film created by fogging and damage could occur. Never start the engine during the storage period.

Clean the Exterior

Make any necessary repairs and clean the vehicle as recommended. See page 124.

Stabilize the Fuel

1. Fill the fuel tank.
2. Add POLARIS Carbon Clean Fuel Treatment or POLARIS Fuel Stabilizer or equivalent fuel treatments or stabilizers. Follow the instructions on the container for the recommended amount. Carbon Clean removes water from fuel systems, stabilizes fuel and removes carbon deposits from pistons, rings, valves and exhaust systems.
3. Allow the engine to run for 15-20 minutes to allow the stabilizer to disperse through the entire fuel delivery system.

Oil and Filter

Change the oil and filter. See page 92.

Air Filter / Air Box

Inspect and clean or replace the pre-filter and air filter. Clean the air box. See pages 106-107.

Fluid Levels

Inspect the fluid levels. Add or change fluids as recommended in the Periodic Maintenance Chart beginning on page 83.

- Demand drive fluid (front gearcase)
- Rear gearcase fluid (if equipped)
- Transmission fluid
- Brake fluid (change every two years and any time the fluid looks dark or contaminated)
- Coolant (test strength/fill)

MAINTENANCE

Cleaning and Storage

Storage Tips

Inspect and Lubricate

Inspect all cables and lubricate all areas of the vehicle as recommended in the Periodic Maintenance Chart beginning on page 83.

Fog the Engine

1. Add POLARIS Carbon Clean or other equivalent fuel treatment. Follow the instructions on the container. Start the engine. Allow it to idle for several minutes so the Carbon Clean reaches the injectors. Stop the engine.
2. Remove the spark plug and add 2-3 tablespoons of engine oil. To access the plug holes, use a section of clear 1/4" hose and a small plastic squeeze bottle filled with the pre-measured amount of oil. *Do this carefully! If you miss the plug holes, oil will drain from the spark plug cavities into the hole at the front of the cylinder head, and appear to be an oil leak.*
3. Reinstall the spark plug. Torque to specification. See page 97.
4. Apply dielectric grease to the inside of each spark plug cap. *Do not reinstall the cap onto the plug at this step.*
5. Turn the engine over several times. Oil will be forced in and around the piston rings and ring lands, coating the cylinder with a protective film of fresh oil.
6. If POLARIS fuel system additive is not used, fuel tank, fuel lines, and injectors should be completely drained of gasoline.
7. Reinstall the spark plug cap to the spark plug.

Battery Maintenance

See pages 121-123 for storage and charging procedures.

Storage Area/Covers

Be sure the storage area is well ventilated. Cover the vehicle with a genuine POLARIS cover. Do not use plastic or coated materials. They do not allow enough ventilation to prevent condensation, and may promote corrosion and oxidation.

Cleaning and Storage

Removal from Storage

1. Check the battery electrolyte level and charge the battery if necessary. Install it in the vehicle. Make sure the battery vent hose is routed properly and that it's not pinched or restricted in any way.
2. Make sure the spark plug is tight.
3. Fill the fuel tank with fuel.
4. Check all the points listed in the Daily Pre-Ride Inspection section on page 54. Tightness of the bolts, nuts and other fasteners should be checked by an authorized POLARIS dealer or other qualified service facility.
5. Lubricate at the intervals outlined in the Periodic Maintenance Chart beginning on page 83.

WARNING! Engine exhaust contains poisonous carbon monoxide and can cause loss of consciousness or death. Never run an engine in an enclosed area.

Transporting the Vehicle

Follow these procedures when transporting the vehicle.

1. Place the transmission in PARK.
2. Stop the engine.
3. Slowly release the brake pedal and make sure the transmission is in PARK before exiting the vehicle.
4. Engage the park brake (if equipped).
5. Remove the key to prevent loss during transporting.
6. Secure the fuel cap and seats. Ensure that the seats are attached correctly and are not loose.

WARNING! Cargo and other loose vehicle parts may fly off while transporting this vehicle. Secure or remove all cargo, and inspect the unit for loose parts prior to transport.

7. Always tie the frame of the POLARIS vehicle to the transporting unit securely with suitable straps or rope. Do not attach tie straps to the front control arm bolt pockets.

SPECIFICATIONS

RZR 570 / 570 EPS

Gross Vehicle Weight	1800 lbs. (816.5 kg) Base Model 1876 lbs. (851 kg) LE Model
Estimated Dry Weight	996 lbs. (452 kg) Base Model 1077 lbs. (488.5 kg) LE Model
Test GVW - Rollover Protection System (ROPS)	1745 lbs. (791.5 kg) Per OSHA 29 CFR 1928.53
Rear Cargo Box Capacity	300 lbs. (136 kg)
Maximum Weight Capacity (Payload)	740 lbs. (336.4 kg) (riders/cargo/accessories/trailer tongue weight)
Receiver Hitch Tongue Capacity	150 lbs. (68 kg)
Receiver Hitch Towing Capacity	1500 lbs. (680 kg)
Fuel Capacity	7 gal. (26.5 l)
Engine Oil Capacity	2 qts. (1.9 l)
Coolant System Capacity	4 qts. (3.76 l) excluding coolant bottle
Coolant Bottle Capacity	8 oz. (237 ml)
Demand Drive Fluid Capacity	6.75 oz. (200 ml)
Transmission Oil Capacity	Standard Models 44 oz. (1300 ml) LE/INTL Models 41 oz. (1200 ml)
Overall Length/Width/Height	107.5/50/69 in. (273/127/175.3 cm)
Wheelbase	77 in. (196 cm)
Ground Clearance	10 in. (25.4 cm)
Engine	Dual overhead cam, 4 valve 4 stroke single cylinder
Displacement	567 cc
Bore x Stroke	99mm x 73.6mm
Alternator Output	650 W @ 7000 RPM
Compression Ratio	10:1
Starting System	Electric
Fuel System	Electronic fuel injection
Ignition System	ECU
Spark Plug / Gap	MR7F / 0.7-0.8 mm
Front Suspension	Independent double a-arm with 9 in. (23 cm) travel
Rear Suspension	Independent double a-arm with 9.5 in. (24 cm) travel

SPECIFICATIONS

RZR 570 / 570 EPS

Lubrication System	Wet Sump
Engine Oil	PS-4 PLUS
Driving System Type	Automatic POLARIS Variable Transmission
Shift Type	Dual Range P/R/N/L/H
Gear Reduction - Low	25.59:1
Gear Reduction - Reverse	22.92:1
Gear Reduction - High	12.05:1
Drive Ratio - Front	3.818:1
Tire Size - Front	25x8-12
Tire Size - Rear	25x10-12
Tire Pressure - ONE RIDER	Front: 7 psi (48 KPa) Rear: 9 psi (62 KPa)
Tire Pressure - TWO RIDERS	Front: 8 psi (55 KPa) Rear: 10 psi (69 KPa)
Brakes, Front/Rear	Foot Activated, 4-wheel hydraulic disc
Headlights (Base Model)	2 single beam, 55W halogen
Headlights (LE Model)	2 dual beam, 6-LED cluster, 40w High / 27w Low
Taillights	2 single beam, 6W
Brake Lights	2 single beam, 27W
Instrument Cluster	LCD
Auxiliary DC Outlet	12V

Clutching (Base Model)

Altitude		Shift Weight	Drive Clutch Spring	Driven Clutch Spring
Meters (Feet)	0-1500 (0-5000)	25-52 PN 5632409	Black PN 7043594	Red/White PN 7044015
	1500-3700 (5000-12000)	25-48 PN 5633217	Black PN 7043594	Red/White PN 7044015

Clutching (LE Model)

Altitude		Shift Weight	Drive Clutch Spring	Driven Clutch Spring
Meters (Feet)	0-1500 (0-5000)	25-52 PN 5632409	Black PN 7043594	Red PN 3234452
	1500-3700 (5000-12000)	25-48 PN 5633217	Black PN 7043594	Red PN 3234452

POLARIS PRODUCTS

Part Number	Description
Engine Lubricant	
2870791	Fogging Oil (12 oz./355 ml Aerosol)
2876244	PS-4 Full Synthetic 5W-50 4-Cycle Oil (qt./.95 l)
2876245	PS-4 Full Synthetic 5W-50 4-Cycle Oil (gal./3.8 l)
Gearcase / Transmission Lubricants	
2878068	AGL Full Synthetic Gearcase Lubricant & Transmission Fluid (qt./.95 l)
2878069	AGL Full Synthetic Gearcase Lubricant & Transmission Fluid (gal./3.8 l)
2870465	Pump for Gallon (3.8 l) Jug
2877922	Demand Drive Fluid (qt./.95 l)
2877923	Demand Drive Fluid (gal./3.8 l)
Coolant	
2880514	Antifreeze 50/50 Premix (qt./.95 l)
2880513	Antifreeze 50/50 Premix (gal./3.8 l)
Grease / Specialized Lubricants	
2871312	Grease Gun Kit, Premium All Season
2871322	All Season Grease (3 oz./89 ml cartridge)
2871423	All Season Grease (14 oz./414 ml cartridge)
2871460	Premium Starter Grease
2871515	U-Joint Grease (3 oz./89 ml cartridge)
2871551	U-Joint Grease (14 oz./414 ml cartridge)
2871329	Dielectric Grease (Nyogel™)
Additives / Miscellaneous	
2871326	Carbon Clean
2870652	Fuel Stabilizer
2872189	DOT 4 Brake Fluid
2871956	Loctite™ 565 Thread Sealant
2859044	POLARIS Battery Tender™ Charger

TROUBLESHOOTING

Drive Belt Wear/Burn

Possible Cause	Solution
Driving onto a pickup or tall trailer in high range	Use low range during loading.
Starting out going up a steep incline	Use low range. See warnings on page 62.
Driving at low RPM or ground speed (3-7 MPH)	Drive at a higher speed or use low range more frequently.
Insufficient warm-up at low ambient temperatures	Warm the engine at least 5 minutes. With the transmission in neutral, advance the throttle to about 1/8 throttle in short bursts, 5 to 7 times. The belt will become more flexible and prevent belt burning.
Slow/easy clutch engagement	Use the throttle quickly and effectively.
Towing/pushing at low RPM/low ground speed	Use low range only.
Utility use/plowing	Use low range only.
Stuck in mud or snow	Shift the transmission to low range and carefully use fast, aggressive throttle application to engage clutch. WARNING: Excessive throttle may cause loss of control and vehicle rollover.
Climbing over large objects from a stopped position	Shift the transmission to low range and carefully use fast, brief, aggressive throttle application to engage clutch. WARNING: Excessive throttle may cause loss of control and vehicle rollover.
Belt slippage from water or snow ingestion into the PVT system	Dry out the PVT (see page 105). Prevent water from entering the PVT intake duct (see page 107). Inspect clutch seals for damage if repeated leaking occurs.
Clutch malfunction	Your POLARIS dealer can assist.
Poor engine performance	Check for fouled plug or foreign material in gas tank or fuel lines. Your POLARIS dealer can assist.
Slippage from failure to warm up belt	Always warm up the belt by operating below 30 mph for one mile (5 miles or more when temperature is below freezing).
Wrong or missing belt	Install the recommended belt.
Improper break-in	Always break in a new belt and/or clutch. See page 52.

TROUBLESHOOTING

Engine Doesn't Turn Over

Possible Cause	Solution
Low battery voltage	Recharge the battery to 12.8 VDC
Loose battery connections	Check all connections and tighten
Loose solenoid connections	Check all connections and tighten
Loose electronic control box connections	Inspect, clean, reinstall connectors

Engine Turns Over, Fails to Start

Possible Cause	Solution
Out of fuel	Refuel
Clogged fuel filter	Your POLARIS dealer can assist.
Water is present in fuel	Drain the fuel system and refuel
Old or non-recommended fuel	Replace with fresh recommended fuel
Fouled or defective spark plug	Inspect plug and replace if necessary
No spark to spark plug	Inspect plug and replace if necessary
Water or fuel in crankcase	Your POLARIS dealer can assist.
Low battery voltage	Recharge the battery to 12.8 VDC
Mechanical failure	Your POLARIS dealer can assist.

Engine Backfires

Possible Cause	Solution
Weak spark from spark plug	Inspect, clean and/or replace spark plug
Incorrect spark plug gap or heat range	Set gap to specs or replace plug
Old or non-recommended fuel	Replace with fresh recommended fuel
Incorrectly installed spark plug wires	Your POLARIS dealer can assist.
Incorrect ignition timing	Your POLARIS dealer can assist.
Mechanical failure	Your POLARIS dealer can assist.
Loose ignition connections	Check all connections and tighten
Water present in fuel	Replace with fresh recommended fuel

TROUBLESHOOTING

Engine Pings or Knocks

Possible Cause	Solution
Poor quality or low octane fuel	Replace with recommended fuel
Incorrect ignition timing	Your POLARIS dealer can assist.
Incorrect spark plug gap or heat range	Set gap to specs or replace plug

Engine Runs Irregularly, Stalls or Misfires

Possible Cause	Solution
Fouled or defective spark plug	Inspect, clean and/or replace spark plug
Worn or defective spark plug wires	Your POLARIS dealer can assist.
Incorrect spark plug gap or heat range	Set gap to specs or replace plug
Loose ignition connections	Check all connections and tighten
Water present in fuel	Replace with new fuel
Low battery voltage	Recharge battery to 12.8 VDC
Kinked or plugged fuel tank vent line	Inspect and replace
Incorrect fuel	Replace with recommended fuel
Clogged air filter	Inspect and clean or replace
Low fuel pressure	Your POLARIS dealer can assist.
Other mechanical failure	Your POLARIS dealer can assist.

Possible Lean Fuel Cause	Solution
Low or contaminated fuel	Add or change fuel, clean the fuel system
Low octane fuel	Replace with recommended fuel
Clogged fuel filter	Your POLARIS dealer can assist.

Possible Rich Fuel Cause	Solution
Fuel is very high octane	Replace with lower octane fuel

TROUBLESHOOTING

Engine Stops or Loses Power

Possible Cause	Solution
Out of fuel	Refuel
Kinked or plugged fuel vent line	Inspect and replace
Water is present in fuel	Replace with new fuel
Fouled or defective spark plug	Inspect, clean and/or replace spark plug
Worn or defective spark plug wires	Your POLARIS dealer can assist.
Incorrect spark plug gap or heat range	Set gap to specs or replace plug
Loose ignition connections	Check all connections and tighten
Low battery voltage	Recharge the battery to 12.8 VDC
Incorrect fuel	Replace with fresh recommended fuel
Clogged air filter	Inspect and clean or replace
Other mechanical failure	Your POLARIS dealer can assist.
Overheated engine	Clean radiator screen and core, clean engine exterior, check coolant level. Your POLARIS dealer can assist.

WARRANTY

Limited Warranty

POLARIS Industries Inc., 2100 Highway 55, Medina, MN 55340 (POLARIS) gives a SIX MONTH LIMITED WARRANTY on all components of your POLARIS vehicle against defects in material or workmanship. POLARIS further warrants that the spark arrester in this product will meet the efficiency requirements of USFS standard 5100-1C for at least 1000 hours when subjected to normal use and when maintenance and installation are in accordance with POLARIS recommendations.

This warranty covers parts and labor charges for repair or replacement of defective parts and begins on the date of purchase by the original retail purchaser. This warranty is transferable to another owner during the warranty period through a POLARIS dealer, but any such transfer will not extend the original term of the warranty. The duration of this warranty may vary by international region based upon local laws and regulations.

Registration

At the time of sale, the Warranty Registration Form must be completed by your dealer and submitted to POLARIS within ten days of purchase. Upon receipt of this registration, POLARIS will record the registration for warranty. No verification of registration will be sent to the purchaser as the copy of the Warranty Registration Form will be your proof of warranty coverage. If you have not signed the original registration and received the customer copy, please contact your dealer immediately. **NO WARRANTY COVERAGE WILL BE ALLOWED UNLESS YOUR VEHICLE IS REGISTERED WITH POLARIS.** Initial dealer preparation and set-up of your vehicle is very important in ensuring trouble-free operation. Purchasing a machine in the crate or without proper dealer set-up will void your warranty coverage.

Warranty Coverage And Exclusions:

Limitations Of Warranties And Remedies

This POLARIS limited warranty excludes any failures that are not caused by a defect in material or workmanship. **THIS WARRANTY DOES NOT COVER CLAIMS OF DEFECTIVE DESIGN.** This warranty also does not cover acts of God, accidental damage, normal wear and tear, abuse or improper handling. This warranty also does not cover any vehicle, component, or part that has been altered structurally, modified, neglected, improperly maintained or used for racing, competition or purposes other than for which it was designed.

This warranty excludes damages or failures resulting from improper lubrication; improper engine timing; improper fuel; surface imperfections caused by external stress, heat, cold or contamination; operator error or abuse; improper component alignment, tension, adjustment or altitude compensation; snow, water, dirt or other foreign substance ingestion/contamination; improper maintenance; modified components; use of aftermarket or unapproved components, accessories, or attachments; unauthorized repairs; or repairs made after the warranty period expires or by an unauthorized repair center.

WARRANTY

Warranty Coverage And Exclusions: Limitations Of Warranties And Remedies

This warranty excludes damages or failures caused by abuse, accident, fire, or any other cause other than a defect in materials or workmanship and provides no coverage for consumable components, general wear items, or any parts exposed to friction surfaces, stresses, environmental conditions and/or contamination for which they were not designed or not intended, including but not limited to the following items:

- Wheels and tires
- Suspension components
- Brake components
- Seat components
- Clutches and components
- Steering components
- Batteries
- Light bulbs/Sealed beam lamps
- Filters
- Lubricants
- Bushings
- Finished and unfinished surfaces
- Carburetor/Throttle body components
- Engine components
- Drive belts
- Hydraulic components and fluids
- Circuit breakers/Fuses
- Electronic components
- Spark plugs
- Sealants
- Coolants
- Bearings

Lubricants and Fluids

1. Mixing oil brands or using non-recommended oil may cause engine damage. We recommend the use of POLARIS engine oil.
2. Damage or failure resulting from the use of non-recommended lubricants or fluids is not covered by this warranty.

This warranty provides no coverage for personal loss or expense, including mileage, transportation costs, hotels, meals, shipping or handling fees, product pick-up or delivery, replacement rentals, loss of product use, loss of profits, or loss of vacation or personal time.

THE EXCLUSIVE REMEDY FOR BREACH OF THIS WARRANTY SHALL BE, AT POLARIS' OPTION, REPAIR OR REPLACEMENT OF ANY DEFECTIVE MATERIALS, COMPONENTS, OR PRODUCTS. THE REMEDIES SET FORTH IN THIS WARRANTY ARE THE ONLY REMEDIES AVAILABLE TO ANY PERSON FOR BREACH OF THIS WARRANTY. POLARIS SHALL HAVE NO LIABILITY TO ANY PERSON FOR INCIDENTAL, CONSEQUENTIAL OR SPECIAL DAMAGES OF ANY DESCRIPTION, WHETHER ARISING OUT OF EXPRESS OR IMPLIED WARRANTY OR ANY OTHER CONTRACT, NEGLIGENCE, OR OTHER TORT OR OTHERWISE. THIS EXCLUSION OF CONSEQUENTIAL, INCIDENTAL, AND SPECIAL DAMAGES IS INDEPENDENT FROM AND SHALL SURVIVE ANY FINDING THAT THE EXCLUSIVE REMEDY FAILED OF ITS ESSENTIAL PURPOSE.

THE IMPLIED WARRANTY OF FITNESS FOR A PARTICULAR PURPOSE IS EXCLUDED FROM THIS LIMITED WARRANTY. ALL OTHER IMPLIED WARRANTIES (INCLUDING BUT NOT LIMITED TO THE IMPLIED WARRANTY OF MERCHANTABILITY) ARE LIMITED IN DURATION TO THE ABOVE SIX MONTH WARRANTY PERIOD. POLARIS DISCLAIMS ALL EXPRESS WARRANTIES NOT STATED IN THIS WARRANTY. SOME STATES DO NOT PERMIT THE EXCLUSION OR LIMITATION OF INCIDENTAL OR CONSEQUENTIAL DAMAGES OR ALLOW LIMITATIONS ON THE DURATION OF IMPLIED WARRANTIES, SO THE ABOVE LIMITATIONS MAY NOT APPLY TO YOU IF INCONSISTENT WITH CONTROLLING STATE LAW.

WARRANTY

How To Obtain Warranty Service

If your vehicle requires warranty service, you must take it to a POLARIS Servicing Dealer. When requesting warranty service you must present your copy of the Warranty Registration Form to the dealer. (THE COST OF TRANSPORTATION TO AND FROM THE DEALER IS YOUR RESPONSIBILITY.) POLARIS suggests that you use your original selling dealer; however, you may use any POLARIS Servicing Dealer to perform warranty service.

In the Country where your product was purchased:

Warranty or Service Bulletin repairs must be done by an authorized POLARIS dealer. If you move or are traveling within the country where your product was purchased, Warranty and Service Bulletin repairs may be requested from any authorized POLARIS dealer that sells the same line as your product.

Outside the Country where your product was purchased:

If you are traveling temporarily outside the country where your product was purchased, you should take your product to an authorized POLARIS dealer. You must show the dealer photo identification from the country of the selling dealer's authorized location as proof of residence. Upon residence verification, the servicing dealer will be authorized to perform the warranty repair.

If you move:

If you move to another country, be sure to contact POLARIS Customer Assistance and the customs department of the destination country before you move. Product importation rules vary considerably from country to country. You may be required to present documentation of your move to POLARIS in order to continue your warranty coverage. You may also be required to obtain documentation from POLARIS in order to register your product in your new country. You should warranty register your product at a local POLARIS dealer in your new country immediately after you move to continue your warranty coverage and to ensure that you receive information and notices regarding your vehicle.

If you purchase from a private party:

If you purchase a POLARIS product from a private party, to be kept and used outside of the country in which the product was originally purchased, all warranty coverage will be denied. You must nonetheless register your product under your name and address with a local POLARIS dealer in your country to ensure that you receive safety information and notices regarding your product.

Exported Products

EXCEPT WHERE SPECIFICALLY REQUIRED BY LAW, THERE IS NO WARRANTY OR SERVICE BULLETIN COVERAGE ON THIS PRODUCT IF IT IS SOLD OUTSIDE THE COUNTRY OF THE SELLING DEALER'S AUTHORIZED LOCATION. This policy does not apply to products that have received authorization for export from POLARIS. Dealers may not give authorization for export. You should consult an authorized dealer to determine this product's warranty or service coverage if you have any questions. This policy does not apply to products registered to government officials or military personnel on assignment outside the country of the selling dealer's authorized location. This policy does not apply to Safety Bulletins.

WARRANTY

Notice

If your product is registered outside of the country where it was purchased and you have not followed the procedure set above, your product will no longer be eligible for warranty or service bulletin coverage of any kind, other than safety bulletins. Products registered to government officials or military personnel on assignment outside of the country where the product was purchased will continue to be covered by the Limited Warranty.

Please work with your dealer to resolve any warranty issues. Should your dealer require any additional assistance, they will contact the appropriate person at POLARIS.

This warranty gives you specific legal rights, and you may also have other rights which vary from state to state or in different countries. If any of the above terms are void because of federal, state, local law, all other warranty terms will remain in effect.

For questions call POLARIS Customer Assistance:

United States & Canada: 1-800-POLARIS (1-800-765-2747)

French: 1-800-268-6334

U.S.A. EPA Emissions Limited Warranty

This emissions limited warranty is in addition to the POLARIS standard limited warranty for your vehicle. POLARIS Industries Inc. warrants that at the time it is first purchased, this emissions-certified vehicle is designed, built and equipped so it conforms with applicable U.S. Environmental Protection Agency emission regulations. POLARIS warrants that the vehicle is free from defects in materials and workmanship that would cause it to fail to meet these regulations.

The warranty period for off road vehicles 100cc or greater emissions-certified vehicles starts on the date of purchase by original retail purchaser and continues for a period of 500 hours of engine operation, 5000 kilometers (3100 miles) of vehicle travel, or 30 calendar months from the date of purchase, whichever comes first. The warranty period for ATVs less than 100cc emissions-certified vehicles starts on the date of purchase by original retail purchaser and continues for a period of 250 hours of engine operation, 2500 kilometers (1550 miles) of vehicle travel, or 30 calendar months from the date of purchase, whichever comes first. This EPA emissions warranty period is extended for at least as long as the standard factory warranty that Polaris provides on the vehicle as a whole. The EPA emissions warranty period does not further extend if you purchase additional warranty coverage in the form of a service contract or other paid warranty extension, but emission-related parts may be covered subject to the terms of any such paid service contract or paid warranty extension.

This emissions limited warranty covers components whose failure increases the vehicle's regulated emissions, and it covers components of systems whose only purpose is to control emissions. Repairing or replacing other components not covered by this warranty is the responsibility of the vehicle owner. This emissions limited warranty does not cover components whose failure does not increase the vehicle's regulated emissions.

For exhaust emissions, emission-related components include any engine parts related to the following systems:

- Air-induction system
- Fuel system
- Ignition system
- Exhaust gas recirculation systems

The following parts are also considered emission-related components for exhaust emissions:

- Aftertreatment devices
- Crankcase ventilation valves
- Sensors
- Electronic control units

WARRANTY

U.S.A. EPA Emissions Limited Warranty

The following parts are considered emission-related components for evaporative emissions:

- Fuel Tank
- Fuel Cap
- Fuel Line
- Fuel Line Fittings
- Clamps*
- Pressure Relief Valves*
- Control Valves*
- Control Solenoids*
- Electronic Controls*
- Vacuum Control Diaphragms*
- Control Cables*
- Control Linkages*
- Purge Valves
- Vapor Hoses
- Liquid/Vapor Separator
- Carbon Canister
- Canister Mounting Brackets
- Carburetor Purge Port Connector

*As related to the evaporative emission control system.

Emission-related components also include any other part whose only purpose is to reduce emissions or whose failure will increase emissions without significantly degrading engine/equipment performance. The exclusive remedy for breach of this limited warranty shall be, at the exclusive option of POLARIS, repair or replacement of any defective materials, components or products. THE REMEDIES SET FORTH IN THIS LIMITED WARRANTY ARE THE ONLY REMEDIES AVAILABLE TO ANY PERSON FOR BREACH OF THIS WARRANTY. POLARIS SHALL HAVE NO LIABILITY TO ANY PERSON FOR INCIDENTAL, CONSEQUENTIAL OR SPECIAL DAMAGES OF ANY DESCRIPTION, WHETHER ARISING OUT OF EXPRESS OR IMPLIED WARRANTY OR ANY OTHER CONTRACT, NEGLIGENCE OR OTHER TORT OR OTHERWISE. THIS EXCLUSION OF CONSEQUENTIAL, INCIDENTAL, AND SPECIAL DAMAGES IS INDEPENDENT FROM AND SHALL SURVIVE ANY FINDING THAT THE EXCLUSIVE REMEDY FAILED OF ITS ESSENTIAL PURPOSE.

ALL IMPLIED WARRANTIES (INCLUDING BUT NOT LIMITED TO ANY IMPLIED WARRANTIES OF MERCHANTABILITY AND FITNESS FOR A PARTICULAR PURPOSE) ARE LIMITED IN DURATION TO THE WARRANTY PERIOD DESCRIBED HEREIN. POLARIS DISCLAIMS ALL EXPRESS WARRANTIES NOT STATED IN THIS WARRANTY. Some states do not allow limitations on how long an implied warranty lasts, so the above limitation may not apply if it is inconsistent with the controlling state law.

This limited warranty excludes failures not caused by a defect in material or workmanship. This limited warranty does not cover damage due to accidents, abuse or improper handling, maintenance or use. This limited warranty also does not cover any engine that has been structurally altered, or when the vehicle has been used in racing competition. This limited warranty also does not cover physical damage, corrosion or defects caused by fire, explosions or other similar causes beyond the control of POLARIS.

WARRANTY

U.S.A. EPA Emissions Limited Warranty

Owners are responsible for performing the scheduled maintenance identified in the owner's manual. POLARIS may deny warranty claims for failures that have been caused by the owner's or operator's improper maintenance or use, by accidents for which POLARIS has no responsibility, or by acts of God.

Any qualified repair shop or person may maintain, replace, or repair the emission control devices or systems on your vehicle. An authorized POLARIS dealer can perform any service that may be necessary for your vehicle. POLARIS also recommends POLARIS parts, however equivalent parts may be used for such service. It is a potential violation of the Clean Air Act if a part supplied by an aftermarket parts manufacturer reduces the effectiveness of the vehicle's emission controls. Tampering with emission controls is prohibited by federal law.

California Residents

Certain POLARIS Off-Road Vehicles are available in 49-state and 50-state versions. Only the 50-state models are certified for sale in California. The 50-state models available for sale in California are identified by the letter "B" in the ninth position of the model number (e.g., R16RTE87B). The POLARIS 50-state models are designed and built with features such as a reduced cargo box capacity. Any modifications to these features may be a violation of the applicable California regulations and may void this limited emissions warranty offered by the manufacturer.

If you have any questions regarding your warranty rights and responsibilities, please contact POLARIS Customer Assistance:

United States & Canada: 1-800-POLARIS (1-800-765-2747)

French: 1-800-268-6334

INDEX

A

- Access Panels 25
- Accessory Outlet 32
- Adding Coolant 100
- Adjustment**
 - Hand Hold 26
 - Seat 28
 - Steering Wheel. 26
- Adjustment, Headlight Beam. 116
- Age Restrictions. 14
- Air Filter 106-107
- Air Filter Cleaning 106-107
- All Wheel Drive**
 - Disengaging AWD. 42
 - Engaging AWD 41
 - Locking the Differential 42
- All Wheel Drive Switch. 34
- All Wheel Drive System 40
- Arrester, Spark, Warning. 108
- Auxiliary Outlet. 32
- AWD Switch 34, 40
- AWD System. 40
- AWD/Rear Differential System. . . 41-43
- Axle Nut Torque 113

B

- Battery 118-123**
 - Charging 122
 - Charging (Sealed Battery) 122-123
 - Extreme Use. 43
 - Fluid Replenishment 121
 - Installation 120
 - Removal. 119
 - Storage 121
- Before Riding. 54
- Belt Burning. 133
- Belt Life. 69
- Belt Replacement. 104
- Belt Wear. 133
- Belts, Seat 29-31
- Boots 9
- Brake Fluid 110
- Brake Inspection 111
- Brake Lever, Park 37
- Brake Lights. 117
- Brake Pedal 36
- Brake System Break-in 53
- Brakes 109-111
- Braking 56
- Break-In Period 52-53
- Burning Belts 133

C

- Cab Frame, ROPS 38
- Cab Nets 27
- Cap, Fuel 28
- Cargo 68-69
- Changing Coolant 100
- Changing Gears 35
- Chart, Periodic Maintenance 83-87
- Check Engine Indicator 51
- Chrome Wheel Care 126
- Cleaning and Storage. 124-129
- Cleaning the Air Filter. 106-107
- Cleaning the Exhaust System 108
- Cleaning the Spark Arrester 108
- Clothing 9
- Clutching 131
- Component Locations 24-25
- Condition, Spark Plugs 97
- Coolant Level 102
- Coolant Level, Radiator. 101
- Coolant, Adding or Changing 100
- Cooling Fan 101
- Cooling System 101-102
- Cooling System Operation. 100
- Corrosion Removal, Chrome. 126
- Cover for Storage. 128
- Crankcase Emission Control System. 82

D

- Demand Drive Fluid 94
- Differential**
 - Locking 42
- Differential Lock Switch 34
- Disengaging AWD 42
- Display Units, Standard/Metric 48
- Drive Belt Wear. 133
- Drivetrain Break-In 52-53
- Driving Downhill. 63
- Driving in Reverse. 66
- Driving on a Sidehill 63
- Driving on Slippery Surfaces 61
- Driving Over Obstacles 65
- Driving Procedures 58-59
- Driving Through Water 64
- Driving Uphill 62
- Driving with a Passenger. 60
- Driving, After Driving in Water 105
- Drying the Transmission 105

E

Electromagnetic Interference	82
Electronic Power Steering	39
Emission Control, Crankcase	82
Emission Control, Exhaust	82
Emission Control, Noise	82
Emissions Limited Warranty	140-142
Engaging AWD	40-41
Engine Break-In	52-53
Engine Fogging	128
Engine Intake Pre-Filter	107
Engine Oil	90-93
Engine Starting	56
Engine Stopping	56
EPS	39
Equipment Modifications	23
Error Codes, Engine	51
Etiquette, Trail Riding	57
Exhaust Cleaning	108
Exhaust Emission Control System	82
Exhaust System Warning	108
Extreme Use Battery	43
Eye Protection	9

F

Fan, Cooling	101
Filling the Battery	121
Filter Care During Storage	127
Filter Cleaning, Air	106-107
Filter, Air	106-107
Fluid	
Demand Drive	94
Front Gearcase	94
Main Gearcase	95
Transmission	95
Fluid Change	
Demand Drive	94
Front Gearcase	94
Main Gearcase	95
Transmission	95
Fluid Check	
Coolant Bottle	102
Demand Drive	94
Front Gearcase	94
Main Gearcase	95
Radiator Coolant	101
Transmission	95
Fluid Levels During Storage	127
Fluid Recommendations, Gearcase	96
Fluid, Battery	121
Fluid, Brake	110
Fogging the Engine	128
Fouled Plugs	97
Freeplay, Steering Wheel	111

Fuel Cap	28
Fuel Safety	22
Fuel Stabilizer	127
Fuel Tank Filler Cap	28
Fuses	98-99

G

Gap, Spark Plug	96
Gasoline Handling	22
Gear Selector	35
Gearcase Capacities	96
Gearcase Oil	
Demand Drive	94
Front	94
Main	95
Gearcase Specifications	96
Gearcases	94-96
Demand Drive	94
Front Gearcase	94
Main Gearcase	95
Specification Chart	96
Transmission	95
Gears, shifting	35
Gloves	9
Grill Removal	25

H

Hand Hold, Passenger	26
Hauling a Load	68-69
Hauling Cargo	68-69
Headlight Beam Adjustment	116
Headlight Lamp Replacement	115
Helmet	8
Hitch	25
Hitch Weight	70
Hood Removal	27

I

Ignition Switch	33
Indicator Lamps	45
Inspection, Axle Nuts	113
Inspection, Brakes	111
Inspection, Pre-Ride	54
Inspection, Steering Wheel	111
Inspection, Wheel Nuts	113
Installation, Battery	120
Installation, Wheels	114
Instrument Cluster	44-51
Interference, Electromagnetic	82

INDEX

K

Key, Periodic Maintenance Chart . . . 84

L

Light Switch 33

Lights **115-117**

Beam Adjustment 116

Brake Lights 117

Headlight Lamp Replacement 115

Loads, Towing 70

Lubricant Part Numbers 132

Lubrication for Storage 128

Lubrication Recommendations . . 88-89

M

Maintenance Log 143

Maintenance, Periodic 83-87

Metric Display 48

Mode Button 44

N

Nets, Cab 27

New Operator Driving Procedure . . 58

New Operator Driving Procedures . . 59

Noise Emission Control System . . . 82

O

Obstacles 65

Oil

Demand Drive 94

Engine 90-93

Front Gearcase 94

Main Gearcase 95

Transmission 95

Oil and Filter Care During Storage 127

Oil Change

Demand Drive 94

Engine 93

Engine Oil 92

Front Gearcase 94

Main Gearcase 95

Transmission 95

Oil Check

Demand Drive 94

Engine Oil 91

Front Gearcase 94

Main Gearcase 95

Transmission 95

Oil Recommendations 90

Operation on Public Lands 82

Operation, Cooling System 100

Operation, Transmission 103-105

Operator Restrictions 14

P

Park Brake Lever 37

Parking on an Incline 67

Parking the Vehicle 57

Passenger Hand Hold Adjustment . . 26

Periodic Maintenance Chart 83-87

Plug Condition 97

Plug Gap 96

Plug Torque 96

Plug, Accessory 32

Plug, Spark 96-97

Plugs, Fouled 97

Polaris Products 132

Polishing the Vehicle 125

Power Steering 39

Pre-Filters, Intake 107

Pre-Ride Inspection 54

Public Lands 82

PVT Break-In 53

PVT Drying 105

PVT Intake Pre-Filter 107

PVT System Operation 103-105

PVT, Cleaning Debris 104

R

Radiator 101

Radiator Access 25

Radiator Coolant Level 101

Receiver Hitch 25

Refueling Safety 22

Registration, Warranty 137

Removal, Battery 119

Removal, Seat 28

Removal, Wheels 114

Removing the Vehicle from Storage 129

Restrictions, Age 14

Reverse 66

Rider Information Center 46-51

Riding Area 57

Riding Gear 8-9

Rollover Protective Structure 38

ROPS Cab Frame 38

INDEX

S

Safe Operation Practices	55
Safety Labels	10-13
Safety Symbols	4
Safety Training	7
Safety Training, ROHVA	55, 58
Safety Warnings	14-23
Safety, Winch Maintenance	81
Seat Adjustment	28
Seat Belts	29-31
Seat Removal	28
Selector, Gear	35
Service Panels	25
Severe Use Definition	83
Shifting Gears	35
Shock Loading the Winch	80
Signal Words	4
Spark Arrester Cleaning	108
Spark Arrester Warning	108
Spark Plug	96-97
Spark Plug Condition	97
Spark Plug Gap	96
Spark Plug Removal	97
Spark Plug Torque	96
Spark Plugs, Fouled	97
Specifications	130
Specifications, Gearcase	96
Speed, Towing	70
Speedometer	44
Spring Preload	112
Stabilizing the Fuel	127
Starting the Engine	56
Steering Wheel Adjustment	26
Steering Wheel Inspection	111
Stopping the Engine	56
Storage	124-129
Storage and Inspection	128
Storage and Lubrication	128
Storage Area	128
Storage, Battery	121
Storage, Covers	128
Storage, Fluid Levels	127
Storage, Oil and Filter	127
Storage, Removal	129
Suspension Settings	112
Switches	32-34
AWD Switch	34, 40
Differential Lock Switch	34
Ignition	33
Light	33
Light Switch	33
Mode Button	44

T

Tachometer	49
Throttle Pedal	36
Tire Tread Depth	113
Tires	113-114
Torque, Axle Nuts	113
Torque, Spark Plug	96
Torque, Wheel Nut	113
Towing a RZR	70
Towing Loads	70
Towing Speed	70
Trail Etiquette	57
Trailer Hitch	25
Training	7
Transmission Oil	95
Transmission Operation	103-105
Transmission, Drying	105
Transporting the Vehicle	129
Tread Depth, Tire	113
Tread Lightly	57

V

Vehicle Identification Numbers	6
Vehicle Immersion	117
Vehicle Transport	129

W

Warning Symbols	4
Washing the Vehicle	124-125
Water, Immersion of Vehicle	117
Wear, Drive Belt	133
Weight, Hitch	70
Wheel Installation	114
Wheel Nut Torque	113
Wheel Removal	114
Winch Cable Care	79
Winch Maintenance/Service Safety	81
Winch Operation	74-78
Winch Safety Precautions	71-73
Winch Shock Loading	80



*For your nearest Polaris dealer,
call 1-800-POLARIS (765-2747)
or visit www.polaris.com*

*Polaris Industries Inc.
2100 Highway 55
Medina, MN 55340*

*Part No. 9928359 Rev 01
Printed in USA*

