



POLARIS®

GENERAL™

★★★★★



2018 OWNER'S MANUAL

**GENERAL 1000 EPS
GENERAL 1000 EPS Deluxe**

⚠ WARNING

Read, understand, and follow all of the instructions and safety precautions in this manual and on all product labels.

Failure to follow the safety precautions could result in serious injury or death.

⚠ WARNING

The engine exhaust from this product contains chemicals known to the State of California to cause cancer, birth defects or other reproductive harm.



For videos and more information about a safe riding experience with your Polaris vehicle, scan this QR code with your smartphone.



2018 Owner's Manual

POLARIS GENERAL 1000

POLARIS® and POLARIS GENERAL™ are trademarks of POLARIS Industries Inc.

Copyright 2016 Polaris Industries Inc. All information contained within this publication is based on the latest product information at the time of publication. Due to constant improvements in the design and quality of production components, some minor discrepancies may result between the actual vehicle and the information presented in this publication. Depictions and/or procedures in this publication are intended for reference use only. No liability can be accepted for omissions or inaccuracies. Any reprinting or reuse of the depictions and/or procedures contained within, whether whole or in part, is expressly prohibited.

The original instructions for this vehicle are in English. Other languages are provided as translations of the original instructions.
Printed in U.S.A.

2018 POLARIS GENERAL 1000 Owner's Manual
9928288

Thank you for purchasing a POLARIS vehicle, and welcome to our world-wide family of POLARIS enthusiasts. Be sure to visit us online at www.polaris.com for the latest news, new product introductions, upcoming events, career opportunities and more.

Here at POLARIS we proudly produce an exciting line of utility and recreational products.

- Snowmobiles
- All-terrain vehicles (ATVs)
- Low emission vehicles (LEVs)
- *RANGER*® utility vehicles
- BRUTUS® work vehicles
- SLINGSHOT® three wheel motorcycles
- RZR® sport vehicles
- GEM® vehicles
- VICTORY® motorcycles
- INDIAN® motorcycles
- POLARIS POWER® generators
- POLARIS DEFENSE® combat vehicles

We believe POLARIS sets a standard of excellence for all utility and recreational vehicles manufactured in the world today. Many years of experience have gone into the engineering, design, and development of your POLARIS vehicle, making it the finest machine we've ever produced.

For safe and enjoyable operation of your vehicle, be sure to follow the instructions and recommendations in this owner's manual.

Your manual contains instructions for minor maintenance, but information about major repairs is outlined in the POLARIS Service Manual and can be performed by a factory certified Master Service Dealer® (MSD) Technician.

Your POLARIS dealer knows your vehicle best and is interested in your total satisfaction. Your POLARIS dealership can perform all of your service needs during, and after, the warranty period.

WELCOME

Introduction	7
Safety	11
Features and Controls	25
Operation	45
Winch Guide.	59
Emission Control Systems	71
Maintenance	73
Specifications	105
POLARIS Products	107
Troubleshooting	109
Warranty	113
Maintenance Log	121

INTRODUCTION

This POLARIS vehicle is an off-road vehicle. Familiarize yourself with all laws and regulations concerning the operation of this vehicle in your area.

The following signal words and symbols appear throughout this manual and on your vehicle. Your safety is involved when these words and symbols are used. Become familiar with their meanings before reading the manual.

WARNING

WARNING indicates a hazardous situation that, if not avoided, may result in death to the operator, bystanders or person(s) inspecting or servicing the vehicle.

CAUTION

CAUTION indicates special precautions that must be taken to avoid vehicle damage or property damage.

CAUTION

SAFETY ALERT CAUTION indicates a potential hazard that may result in minor personal injury or damage to the vehicle.

IMPORTANT

IMPORTANT provides key reminders during disassembly, assembly, and inspection of components.

NOTICE

NOTICE provides key information by clarifying instructions.



The Prohibition Safety Sign indicates an action **NOT** to take in order to avoid a hazard.



The Mandatory Action Sign indicates an action that **NEEDS** to be taken to avoid a hazard.

WARNING

Failure to heed the warnings and safety precautions contained in this manual can result in severe injury or death. Your POLARIS vehicle is not a toy and can be hazardous to operate. This vehicle handles differently than cars, trucks or other off-road vehicles. A collision or rollover can occur quickly, even during routine maneuvers like turning, or driving on hills or over obstacles, if you fail to take proper precautions.

- Read this owner's manual and review the safety DVD that came with your vehicle. A free extra copy of the DVD can be obtained by contacting your local POLARIS dealer. Understand all safety warnings, precautions and operating procedures before operating the vehicle. Keep this manual with the vehicle.
- Review the safety DVD and take the free online Recreational Off-Highway Vehicle Association (ROHVA) training course at www.rohva.org.
- This vehicle is an ADULT VEHICLE ONLY. You MUST be at least age 16 and have a valid driver's license to operate this vehicle.
- No person under the age of 12 may ride as a passenger in this vehicle. All riders must be able to sit with backs against the seat, both feet flat on the floor and both hands on the steering wheel (if driving) or on a passenger hand hold.
- Never permit a guest to operate this vehicle unless the guest has reviewed the owner's manual and all safety labels and has completed a safety training course.
- Always use the cab doors while riding in this vehicle. Always keep hands, feet and all other body parts inside the vehicle at all times.
- Always wear a helmet, eye protection, gloves, long-sleeve shirt, long pants and over-the-ankle boots.
- Never use this vehicle with drugs or alcohol, as these conditions impair judgment and reduce operator reaction time.

EUROPEAN VIBRATION AND NOISE

The driver-perceived noise and hand/arm and whole body vibration levels of this machinery is measured per EN 15997.

The operating conditions of the machinery during testing:

The vehicles were in like-new condition. The environment was controlled as indicated by the test procedure(s).

The uncertainty of vibration exposure measurement is dependent on many factors, including:

- Instrument and calibration uncertainty
- Variations in the machine such as wear of components
- Variation of machine operators such as experience or physique
- Ability of the worker to reproduce typical work during measurements
- Environmental factors such as ambient noise or temperature

VEHICLE IDENTIFICATION NUMBERS

Record your vehicle's identification numbers and key number in the spaces provided. Remove the spare key and store it in a safe place. An ignition key can be duplicated only by ordering a POLARIS key blank (using your key number) and mating it with one of your existing keys. The ignition switch must be replaced if all keys are lost.

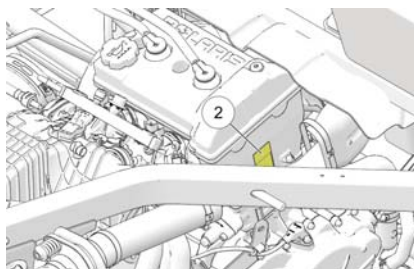
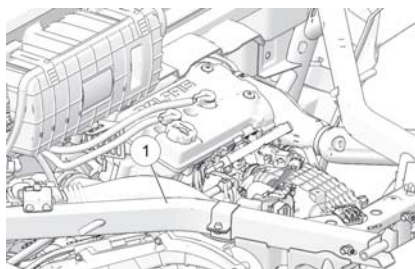

Vehicle Model Number:	
Frame VIN ①:	
Engine Serial Number ②:	
Key Number	

SAFETY

SAFETY TRAINING

Safety training is a top priority for POLARIS. POLARIS strongly encourages you and any family members who will be riding this vehicle to take a training course.

ROHVA (Recreational Off-Highway Vehicle Association) provides both an online safety e-course and a hands-on safety course. Visit www.rohva.org or call 866-267-2751.

Your POLARIS vehicle is considered an off-road vehicle. Familiarize yourself with all laws and regulations concerning the operation of this vehicle in your area.

We strongly advise you to strictly follow the recommended maintenance program outlined in your owner's manual. This preventive maintenance program is designed to ensure that all critical components on your vehicle are thoroughly inspected at specific intervals.

For more information about recreational off-road vehicle safety in the United States, visit www.rohva.org, call 866-267-2751 or call POLARIS at 800-342-3764.

SAFETY

SAFE RIDING GEAR

Always wear helmet, eye protection, gloves, long-sleeve shirt, long pants, over-the-ankle boots and seat belt at all times. Protective gear reduces the chance of injury.

RIDER COMFORT

Under certain operating conditions, heat generated by the engine and exhaust system can elevate temperatures in the rider cab area. The condition occurs most frequently when a vehicle is being operated in high ambient temperatures at low speeds and/or high load conditions for an extended period of time. The use of certain windshield, roof and/or cab systems may contribute to this condition by restricting airflow. Any discomfort due to heat buildup in this area can be minimized by wearing proper riding apparel and by varying speeds to increase airflow.



- | | |
|------------------|------------------------|
| ① Helmet | ④ Gloves |
| ② Eye Protection | ⑤ Long Pants |
| ③ Long Sleeves | ⑥ Over-the-Ankle Boots |

HELMET

Wearing a helmet can prevent a severe head injury. Whenever riding this POLARIS vehicle, always wear a helmet that meets or exceeds established safety standards.

Approved helmets in the USA and Canada bear a U.S. Department of Transportation (DOT) label.

Approved helmets in Europe, Asia and Oceania bear the ECE 22.05 label. The ECE mark consists of a circle surrounding the letter E, followed by the distinguishing number of the country which has granted approval. The approval number and serial number will also be displayed on the label.

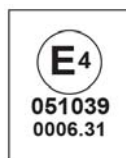

EYE PROTECTION

Do not depend on eyeglasses or sunglasses for eye protection. Whenever riding this POLARIS vehicle, always wear shatterproof goggles or use a shatterproof helmet face shield. POLARIS recommends wearing approved Personal Protective Equipment (PPE) bearing markings such as VESC 8, V-8, Z87.1, or CE. Make sure protective eye wear is kept clean.

GLOVES

Wear gloves for comfort and for protection from sun, cold weather and other elements.

BOOTS

Wear sturdy over-the-ankle boots for support and protection. Never ride a POLARIS vehicle with bare feet or sandals.

CLOTHING

Wear long sleeves and long pants to protect arms and legs.

SAFETY

SAFETY LABELS AND LOCATIONS

Warning labels have been placed on the vehicle for your protection. Read and follow the instructions of the labels on the vehicle carefully. If any of the labels depicted in this manual differ from the labels on your vehicle, always read and follow the instructions of the labels *on the vehicle*.

If any label becomes illegible or comes off, contact your POLARIS dealer to purchase a replacement. Replacement *safety* labels are provided by POLARIS at no charge. The part number is printed on the label.

PROPER USE WARNING (7182649)

The Proper Use Warning ① is located on the center console.

Require Proper Use of Your Vehicle

Do your part to prevent injuries:

- Do not allow careless or reckless driving.
- Make sure operators are 16 or older with a valid driver's license.
- Do not let people drive or ride after using alcohol or drugs.
- Do not allow operation on public roads (unless designated for off-highway vehicle access) - collisions with cars and trucks can occur.
- Do not exceed seating capacity: 2 occupants

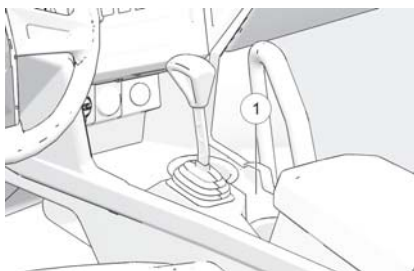

PAYLOAD WARNING/SHIFT CAUTION (7184118)

The Payload/Shift Caution safety label is located on the center console.

WARNING

POLARIS	NEVER EXCEED	IF TOTAL PAYLOAD EXCEEDS
GENERAL	43 MPH (69 km/h)	430 lbs. (195 kg)

CAUTION

To avoid transmission damage, shift only when vehicle is stationary and at idle. When vehicle is stopped, place shift in parked position.

SEAT BELT/DRIVE RESPONSIBLY WARNING

WARNING

Improper vehicle use can result in SEVERE INJURY or DEATH

BE PREPARED

- Fasten seat belts.
- Wear an approved helmet and protective gear.
- ALWAYS use cab nets and/or doors.
- Each rider must be able to sit with back against seat, feet flat on the floor, and hands on steering wheel or hand holds. Stay completely inside the vehicle.

Drive Responsibly

Avoid loss of control and rollovers:

- Avoid abrupt maneuvers, sideways sliding, skidding or fishtailing, and never do donuts.
- Slow down before entering a turn.
- Avoid hard acceleration when turning, even from a stop.
- Plan for hills, rough terrain, ruts and other changes in traction and terrain. Avoid paved surfaces.
- Avoid sidehilling (riding across slopes).

Be Sure Riders Pay Attention and Plan Ahead

If you think or feel the vehicle may tip or roll, reduce your risk of injury:

- Keep a firm grip on the steering wheel or hand holds and brace yourself.
- Do not put any part of your body outside of the vehicle for any reason.

LOCATE AND READ OWNER'S MANUAL. FOLLOW ALL INSTRUCTIONS AND WARNINGS. ALWAYS REVIEW SAFETY VIDEO AND TAKE ROHVA TRAINING (rohva.org).

CLUTCH COVER WARNING (7177469)

The clutch cover warning ① is located on the clutch cover.

WARNING

Improper service or maintenance of this PVT system can result in vehicle damage, SEVERE INJURY or DEATH.

Always look for and remove debris inside and around clutch and vent system when replacing belt.

Read owner's manual or see authorized POLARIS dealer.

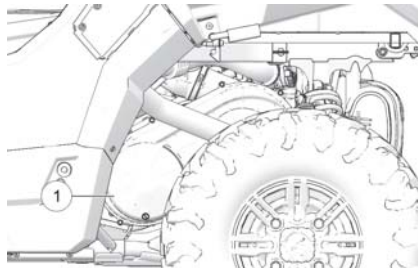

SAFETY

LOAD/PASSENGER/TIRE PRESSURE WARNING (7188333)

The Load/Passenger/Tire Pressure warning decal is located on the front panel of the rear cargo box ①.

WARNING

- Never carry passengers in cargo box.
- Passengers can be thrown off. This can cause serious injury or death.
- If total payload is greater than 500 lbs., the vehicle must be operated in LOW range.

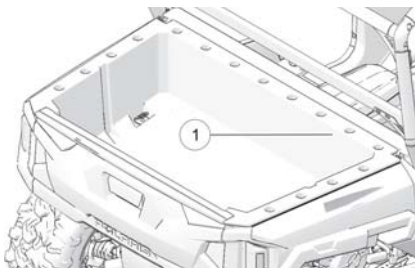

IMPROPER TIRE PRESSURE OR OVERLOADING CAN CAUSE LOSS OF CONTROL RESULTING IN SERIOUS INJURY OR DEATH.

- Reduce speed and allow greater distance for braking when carrying cargo.
- Overloading or carrying tall, off-center, or unsecured loads will increase your risk of losing control. Loads should be centered and carried as low as possible in box.
- For stability on rough or hilly terrain, reduce speed and cargo.

RANGER	GENERAL BASE (12-INCH WHEELS)	GENERAL (14-INCH WHEELS)	GENERAL 4
MAXIMUM CARGO BOX LOAD	600 lbs. (272 Kg)	600 lbs. (272 Kg)	600 lbs. (272 Kg)
TIRE PRESSURE IN PSI (KPa)	FRONT 10 (69) REAR 18 (125)	FRONT 12 (87) REAR 14 (96)	FRONT 16 (110) REAR 20 (137)
MAXIMUM WEIGHT CAPACITY INCLUDES WEIGHT OF OPERATOR, PASSENGERS, CARGO, AND ACCESSORIES	1030 lbs. (467 Kg)	1030 lbs. (467 Kg)	1280 lbs. (580 Kg)
Read Operation and Maintenance Manual for more detailed loading information.			

FUEL TRANSPORT WARNING (7185278)

The Fuel Transport Warning is located in the cargo box.

WARNING

NEVER carry fuel or other flammable liquids on this vehicle. Failure to follow this instruction could lead to serious burn injuries or death.

OPERATOR SAFETY

WARNING

Serious injury or death can result if you do not follow these instructions and procedures, which are outlined in further detail within your owner's manual.

- Read this entire manual and all labels carefully. Follow the operating procedures described.
- Never allow anyone under the age of 16 to operate this vehicle and never allow anyone without a valid driver's license to operate this vehicle.
- Do not carry a passenger until you have at least two hours of driving experience with this vehicle.
- No person under the age of 12 may ride as a passenger in this vehicle. All riders must be able to sit with backs against the seat, both feet flat on the floor and both hands on the steering wheel (if driving) or on a passenger hand hold.
- The driver and all passengers must wear helmet, eye protection, gloves, long-sleeve shirt, long pants, over-the-ankle boots and seat belt at all times.
- Always use the cab doors while riding in this vehicle.
- Always keep hands and feet inside the vehicle at all times.
- Always keep both hands on the steering wheel and both feet on the floorboards of the vehicle during operation.
- Never permit a guest to operate this vehicle unless the guest has read this manual and all product labels.
- To reduce rollover risk, be especially careful when encountering obstacles and slopes and when braking on hills or during turns.
- This vehicle is for off road use only. Never operate on public roads (unless marked for off-road use). Always avoid paved surfaces.
- Never consume alcohol or drugs before or while operating this vehicle.
- Never operate at excessive speeds. Always travel at a speed proper for the terrain, visibility and operating conditions, and your experience.
- Never attempt jumps or other stunts.
- Always inspect the vehicle before each use to make sure it's in safe operating condition. Always follow the inspection procedures described in this manual.
- Always travel slowly and use extra caution when operating on unfamiliar terrain. Be alert to changing terrain.
- Never operate on excessively rough, slippery or loose terrain.
- Always follow proper procedures for turning. Practice turning at slow speeds before attempting to turn at faster speeds. Never turn at excessive speeds.

SAFETY

- Always have this vehicle checked by an authorized POLARIS dealer if it has been involved in an accident.
- Never operate this vehicle on hills too steep for the vehicle or for your abilities. Practice on smaller hills before attempting larger hills.
- Always follow proper procedures for climbing hills as described in this manual. See page 55. Check the terrain carefully before attempting to climb a hill. Never climb hills with excessively slippery or loose surfaces. Never apply throttle suddenly. Never make sudden gear changes. Never go over the top of a hill at high speed.
- Always follow the proper procedures outlined in this manual for traveling downhill and for braking on hills. See page 56. Check the terrain carefully before descending a hill. Never travel downhill at high speed. Avoid going downhill at an angle, which would cause the vehicle to lean sharply to one side. Travel straight down the hill where possible.
- Always check for obstacles before operating in a new area. Never attempt to operate over large obstacles such as large rocks or fallen trees. Always follow the proper procedures outlined in this manual when operating over obstacles. See page 54.
- Always be careful of skidding or sliding. On slippery surfaces such as ice, travel slowly and exercise caution to reduce the chance of skidding or sliding out of control.
- Never operate your vehicle in fast-flowing water or in water deeper than that specified in this manual. See page 56. Wet brakes may have reduced stopping ability. Test your brakes after leaving water. If necessary, apply them lightly several times to let friction dry out the pads.
- Always be sure there are no obstacles or people behind your vehicle when operating in reverse. When it's safe to proceed in reverse, move slowly. Avoid turning at sharp angles in reverse.
- Always use the proper size and type of tires specified in this manual. Always maintain proper tire pressure as specified on safety labels.
- Never modify this vehicle through improper installation or use of non-POLARIS approved accessories.
- Never exceed the stated load capacity for this vehicle. Cargo should be properly distributed and securely attached. Reduce speed and follow the instructions in this manual for hauling cargo or pulling a trailer. Allow a greater distance for braking.
- Always place the transmission in PARK before getting out of the vehicle.
- Always stop the engine before refueling. Remove flammable material containers from the box before filling them with fuel. Make sure the refueling area is well ventilated and free of any source of flame or sparks. Gasoline is extremely flammable. See the Refueling section for fuel safety warnings.
- Always remove the ignition key when the vehicle is not in use to prevent unauthorized use by someone under the age of 16 or without a driver's license and proper training, or accidental starting.

EQUIPMENT MODIFICATIONS

Your POLARIS vehicle is designed to provide safe operation when used as directed. Modifications to your vehicle may negatively impact vehicle stability. Failure of critical machine components may result from operation with any modifications, especially those that increase speed or power. This vehicle may become less stable at speeds higher than those for which it is designed. Loss of control may occur at higher speeds.

Do not install any non-POLARIS-approved accessory or modify the vehicle for the purpose of increasing speed or power. Any modifications or installation of non-POLARIS-approved accessories could create a substantial safety hazard and increase the risk of bodily injury.

The POLARIS limited warranty on your POLARIS vehicle will be terminated if any non-POLARIS approved equipment and/or modifications have been added to the vehicle that increase speed or power.

The addition of certain accessories, including (but not limited to) mowers, blades, tires, sprayers, or large racks, may change the handling characteristics of the vehicle. Use only POLARIS-approved accessories, and familiarize yourself with their function and effect on the vehicle.

**FOR MORE INFORMATION ABOUT SAFETY
call POLARIS at 1-800-342-3764.**

AGE RESTRICTIONS

This vehicle is an ADULT VEHICLE ONLY.

Operation is prohibited for anyone under 16 years of age or anyone without a valid driver's license.

The operator must be tall enough to sit with back against the seat, both feet flat on the floor and both hands on the steering wheel.



SAFETY

OPERATING WITHOUT INSTRUCTION

Operating this vehicle without proper instruction increases the risk of an accident. The operator must understand how to operate the vehicle properly in different situations and on different types of terrain.

All operators must read and understand the owner's manual and all warning and instruction labels before operating the vehicle.

All operators should review the safety DVD provided with this vehicle and take a ROHVA training course (www.rohva.org).



USING ALCOHOL OR DRUGS

Operating this vehicle after consuming alcohol or drugs could adversely affect operator judgment, reaction time, balance and perception.

Never consume alcohol or drugs before or while operating this vehicle.



SEAT BELTS

Riding in this vehicle without wearing the seat belt increases the risk of serious injury in the event of rollover, loss of control, other accident or sudden stop. Seat belts may reduce the severity of injury in these circumstances.

The operator **MUST** wear the seat belt at all times.

PROTECTIVE APPAREL

Riding in this vehicle without wearing an approved helmet and protective eyewear increases the risk of a serious injuries in the event of an accident.

Operator and all passengers *must* always wear an approved helmet that fits properly and eye protection (goggles or face shield).

CAB DOORS

Riding in this vehicle without closed and latched cab doors increases the risk of serious injury or death in the event of an accident or rollover. Always make sure all cab doors are closed and latched while riding in this vehicle. Cab doors are NOT intended to be used as arm rests. Always keep hands and feet inside the vehicle at all times.

FAILURE TO INSPECT BEFORE OPERATING

Failure to inspect and verify that the vehicle is in safe operating condition before operating increases the risk of an accident.

Always perform the pre-ride inspection before each use of your vehicle to make sure it's in safe operating condition. See the Pre-Ride Inspection Section for details.

Always follow the inspection and maintenance procedures and schedules described in this owner's manual. See the Maintenance Chart Key section for details.

OPERATING WITH A LOAD ON THE VEHICLE

The weight of both cargo and operator impacts vehicle operation and stability. For your safety and the safety of others, carefully consider how your vehicle is loaded and how to safely operate the vehicle. Follow the instructions in this manual for loading, tire pressure, gear selection and speed.

- **Do not exceed vehicle weight capacities.** The vehicle's maximum weight capacity is listed in the specifications section of this manual and on a label on the vehicle. When more passenger weight is added, cargo weight may need to be reduced accordingly.
- The recommended tire pressures are listed in the specifications section of this manual and on a label on the vehicle.

Always follow these guidelines:

UNDER ANY OF THESE CONDITIONS:	DO ALL OF THESE STEPS:
Passenger and/or cargo exceeds half the maximum weight capacity	<ol style="list-style-type: none"> 1. Slow down. 2. Verify tire pressure. 3. Use extra caution when operating.
Operating in rough terrain	
Operating over obstacles	
Climbing an incline	
Towing	

SAFETY

REFUELING

Gasoline is highly flammable and explosive under certain conditions.

- Always exercise extreme caution whenever handling gasoline.
- Always turn off the engine when refueling.
- Always refuel outdoors or in a well ventilated area free of any source of flame or sparks.
- Never carry fuel or other flammable liquids on this vehicle. Failure to follow this instruction could lead to serious burn injuries or death.
- Do not smoke or allow open flames or sparks in or near the area where refueling is performed or where gasoline is stored.
- Do not overfill the tank. Do not fill the tank neck.
- If gasoline spills on your skin or clothing, immediately wash it off with soap and water and change clothing.

OPERATING A DAMAGED VEHICLE

Operating a damaged vehicle can result in an accident. After any rollover or other accident, have a qualified service dealer inspect the entire machine for possible damage, including (but not limited to) seat belts, rollover protection devices, brakes, throttle and steering systems.

OPERATING AT EXCESSIVE SPEEDS

Operating this vehicle at excessive speeds increases the operator's risk of losing control. Always operate at a speed that's appropriate for the terrain, the visibility and operating conditions and your skills and experience.

OPERATING ON PAVEMENT

This vehicle's tires are designed for off-road use only, not for use on pavement. Operating this vehicle on paved surfaces (including sidewalks, paths, parking lots and driveways) may adversely affect the handling of the vehicle and may increase the risk of loss of control and accident or rollover. Avoid operating the vehicle on pavement. If it's unavoidable, travel slowly, travel short distances and avoid sudden turns or stops.

OPERATING ON PUBLIC ROADS

Operating this vehicle on public streets, roads or highways could result in a collision with another vehicle. Never operate this vehicle on any public street, road or highway, including dirt and gravel roads (unless designated for off-highway use).

TURNING IMPROPERLY

Turning improperly could cause loss of traction, loss of control, accident or rollover. Always follow proper procedures for turning as described in this owner's manual.

Avoid sharp turns. Never turn while applying heavy throttle. Never make abrupt steering maneuvers. Practice turning at slow speeds before attempting to turn at faster speeds.

OPERATING IN UNFAMILIAR TERRAIN

Failure to use extra caution when operating on unfamiliar terrain could result in an accident or rollover.

Unfamiliar terrain may contain hidden rocks, bumps, or holes that could cause loss of control or rollover.

Travel slowly and use extra caution when operating on unfamiliar terrain. Always be alert to changing terrain conditions.

JUMPS AND STUNTS

Exhibition driving increases the risk of an accident or rollover. DO NOT do power slides, "donuts", jumps or other driving stunts. Avoid exhibition driving.

IMPROPER HILL CLIMBING

Improper hill climbing could cause loss of control or rollover. Use extreme caution when operating on hills. Always follow proper procedures for hill climbing as described in this owner's manual.

DESCENDING HILLS IMPROPERLY

Improperly descending a hill could cause loss of control or rollover. Always follow proper procedures for traveling down hills as described in this owner's manual.

STALLING WHILE CLIMBING A HILL

Stalling or rolling backwards while climbing a hill could cause a rollover. Maintain a steady speed when climbing a hill.

If you lose all forward speed:

Apply the brakes gradually until the vehicle is fully stopped. Place the transmission in reverse and slowly allow the vehicle to roll straight downhill while applying light brake pressure to control speed.

If you begin rolling downhill:

Never apply engine power. Apply the brakes gradually until the vehicle is fully stopped. Place the transmission in reverse and slowly allow the vehicle to roll straight downhill while applying light brake pressure to control speed.

IMPROPER TIRE MAINTENANCE

Operating this vehicle with improper tires or with improper or uneven tire pressure could cause loss of control or accident.

Always use the size and type of tires specified for your vehicle.

Always maintain proper tire pressure as described in the owner's manual and on safety labels.



SAFETY

SKIDDING OR SLIDING

Failure to use extra caution when operating on excessively rough, slippery or loose terrain could cause loss of traction, loss of control, accident or rollover. Do not operate on excessively slippery surfaces. Always slow down and use additional caution when operating on slippery surfaces.

Skidding or sliding due to loss of traction can cause loss of control or rollover (if tires regain traction unexpectedly). Always follow proper procedures for operating on slippery surfaces as described in this owner's manual.

OPERATING ON FROZEN BODIES OF WATER

Severe injury or death can result if the vehicle and/or the operator fall through the ice. Never operate the vehicle on a frozen body of water unless you have first verified that the ice is sufficiently thick to support the weight and moving force of the vehicle, you and your cargo, together with any other vehicles in your party.

Always check with local authorities and residents to confirm ice conditions and thickness over your entire route. Vehicle operators assume all risk associated with ice conditions on frozen bodies of water.

UNAUTHORIZED USE OF THE VEHICLE

Leaving the keys in the ignition can lead to unauthorized use of the vehicle by someone under the age of 16, without a drivers license, or without proper training. This could result in an accident or rollover. Always remove the ignition key when the vehicle is not in use.

EXPOSURE TO EXHAUST

Engine exhaust fumes are poisonous and can cause loss of consciousness or death in a short time. Never start the engine or let it run in an enclosed area.

The engine exhaust from this product contains chemicals known to cause cancer, birth defects or other reproductive harm. Operate this vehicle only outdoors or in well-ventilated areas.

HOT EXHAUST SYSTEMS

Exhaust system components are very hot during and after use of the vehicle. Hot components can cause burns and fire. Do not touch hot exhaust system components. Always keep combustible materials away from the exhaust system. Use caution when traveling through tall grass, especially dry grass, to avoid debris build-up around the exhaust system.

FEATURES AND CONTROLS

COMPONENT LOCATIONS

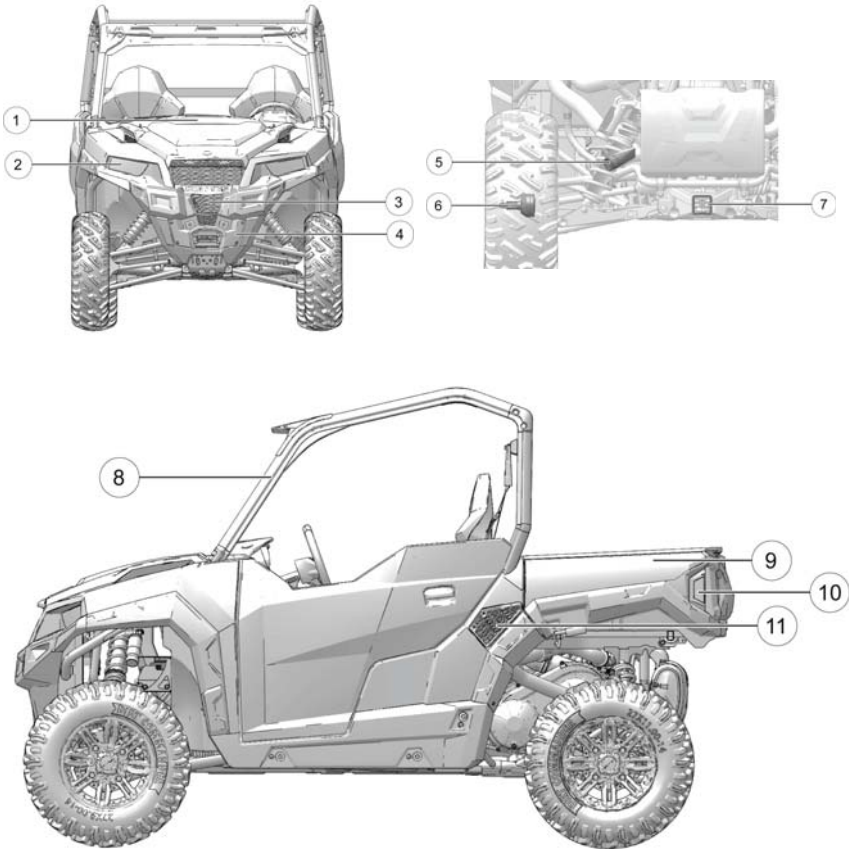

- ① Console
- ② Headlights
- ③ Radiator
- ④ Front Bumper/ Brush Guard
- ⑤ Muffler (Spark Arrester)
- ⑥ CV Boot/Rear Caliper

- ⑦ Receiver Hitch
- ⑧ ROPS Cab Frame
- ⑨ Cargo Box
- ⑩ Taillights
- ⑪ PVT Intake Screen

FEATURES AND CONTROLS

GEAR SELECTOR

Low gear is the primary driving range for your vehicle. High gear is intended for use on hard-packed surfaces with light loads. Using high gear for heavy loads, hilly terrain or in wet, muddy conditions will increase the chance of drive belt burning. See the Drive Belt Wear/Burn section on page 109.

To shift gears, brake to a complete stop. When the engine is idling, move the lever ① to the desired gear.

H: High Gear
L: Low Gear
N: Neutral
R: Reverse
P: Park



NOTICE

Shifting gears with the engine speed above idle or while the vehicle is moving could cause transmission damage. Always shift when the vehicle is stationary and the engine is at idle.

TIP

Maintaining shift linkage adjustment is important to assure proper transmission function. Your POLARIS dealer can assist in resolving any shifting problems.

USING LOW RANGE

Always shift into low gear for any of the following conditions.

- Operating in rough terrain or over obstacles
- Loading the vehicle onto a trailer
- Towing loads
- Driving frequently at low RPM or at ground speeds below 7 MPH (11 km/h)

SWITCHES

IGNITION SWITCH

The ignition switch is a four-position, key-operated switch. The key can be removed from the switch when it is in the OFF position.



OFF	The engine is off. Electrical circuits are off, except Acc, 12V.
ACCESSORY (if equipped)	The engine is off. Powers the gauge and terminal block. Check engine and steering warning indicators will appear on the gauge in this mode, but will turn off when the vehicle is started if no issues are present.
ON	Electrical circuits are on. Electrical equipment can be used.
START	Turn the key to the START position to engage the electric starter. The key returns to the ON position when released.

AWD/DIFFERENTIAL LOCK SWITCH

The AWD switch has three positions:

- All Wheel Drive (AWD)
- Two Wheel Drive (2WD)
- Differential Unlock (TURF mode)

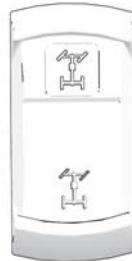

FEATURES AND CONTROLS

LIGHT SWITCH

The ignition switch key must be in the ON/ RUN position to operate the headlights. Press the top of the switch to place the headlights on high beam. Move the switch to the center position to place the headlights on low beam. Press the bottom of the switch to turn off the headlights.

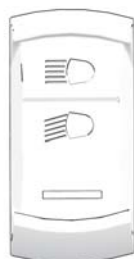

WINCH SWITCH

Press the top of the rocker switch to spool line out from the winch. Press the bottom of the rocker switch to spool line in to the winch. Move the rocker switch to the center position to stop spooling.



AUXILIARY OUTLET

The vehicle is equipped with a 12-volt accessory outlet on the dash. Use the outlet to power an auxiliary light or other optional accessories or lights. For service, the dash outlet connection is under the dash.



FOOT PEDALS

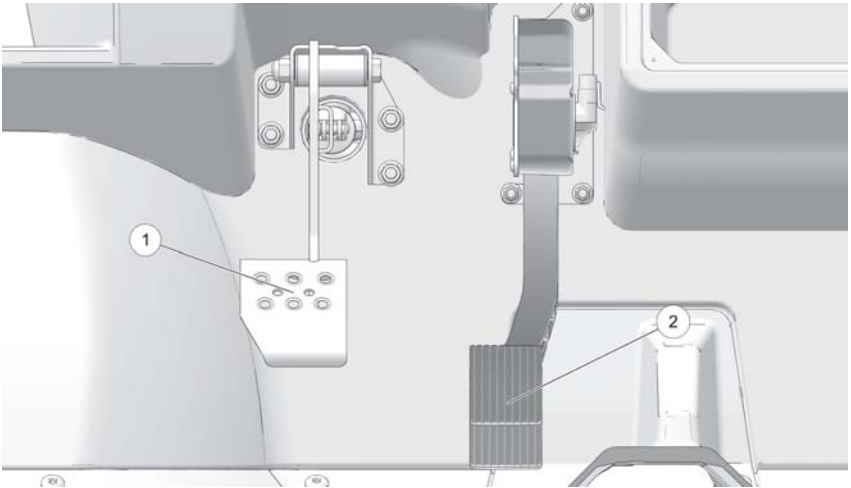

BRAKE PEDAL

Depress the brake pedal ① to slow or stop the vehicle. Apply the brakes while starting the engine.

When the brake pedal is depressed, the brake light comes on. Check the brake light before each ride.

1. Turn the ignition switch to the ON position.
2. Apply the brakes. The brake light should come on after about 10 mm (0.4 in.) of pedal travel.

THROTTLE PEDAL

Push the throttle pedal ② down to increase engine speed. Spring pressure returns the pedal to the rest position when released. Always check that the throttle pedal returns normally before starting the engine.

TIP

If the throttle pedal and brake pedal are applied simultaneously, engine power may be limited.

SEATS

SEAT BELTS



This vehicle is equipped with three-point lap and diagonal seat belts for the operator and passengers. Always make sure the seat belts are secured for all riders before operating. The driver's seat belt is equipped with a seat belt interlock. Vehicle speed will be limited to 15 MPH (24 km/h) if the seat belt is not secured.

WARNING

Falling from a moving vehicle could result in serious injury or death. Always fasten your seat belt securely before operating or riding in the vehicle.

To wear the seat belt properly, follow this procedure:

1. For 3-point belts, pull the seat belt latch ① downward and across your chest toward the buckle at the inner edge of the seat. The belt should fit snugly across your hips and diagonally across your chest. Make sure the belt is not twisted.
2. Push the latch plate ① into the buckle ② until it clicks.
3. Release the strap, it will self tighten.
4. To release the seat belt, press the square red button in the buckle's center.

SEAT BELT INSPECTION

Inspect all seat belts for proper operation before each use of the vehicle.

1. Push the latch plate into the buckle until it clicks. The latch plate must slide smoothly into the buckle. A click indicates that it's securely latched.
2. Push the red release latch in the middle of the buckle to make sure it releases freely.
3. Pull each seat belt completely out and inspect the full length for any damage, including cuts, wear, fraying or stiffness. If any damage is found, or if the seat belt does not operate properly, have the seat belt system checked and/or replaced by an authorized dealer.
4. To clean dirt or debris from the seat belts, sponge the straps with mild soap and water. Do not use bleach, dye or household detergents. Rinse the entire length of the belt webbing. Use a garden hose to flush out the retractor and latch housings regularly.

SEAT AND STORAGE COMPARTMENTS

A small storage compartment is located behind the passenger seat ①.

If your model is equipped with a storage console and cup holders located between the seats, lift the console lid to access the storage compartment.

The ECU is located in the compartment behind the driver's seat. Do not use this area for storage.

The electrical compartment is located under the driver's seat. Never use the electrical compartment for storage. Remove the driver's seat to access the battery and fuse box.

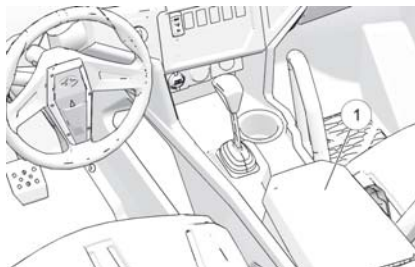

SEAT REMOVAL AND COMPARTMENT ACCESS

Pull the rear edge of a seat upward to release the latch pins from the grommets. Roll the seat forward to access the under-seat area. To completely remove a seat, roll the seat forward and lift the seat tabs from the seat base mounts.

Always make sure all seats are properly installed and securely latched before operating. Push down firmly on the rear of each seat until the latch pins are fully seated into the grommets.

FEATURES AND CONTROLS

ELECTRONIC POWER STEERING (EPS)

Electronic power steering (if equipped) engages when the ignition key is turned to the ON position. EPS remains engaged whether the vehicle is moving or idle. To conserve battery power, the EPS will shut down 5 minutes after the engine is stopped if the key remains in the ON position. The EPS warning indicator will illuminate to indicate the EPS has shut down. Turn the key off and on to reset the unit. If the light remains on after starting the engine, the EPS system is inoperative. Your POLARIS dealer can assist.

ADJUSTABLE STEERING WHEEL

The steering wheel can be tilted upward or downward for rider preference.

Lift and hold the adjustment lever while moving the steering wheel upward or downward. Release the lever when the steering wheel is at the desired position.

ROLLOVER PROTECTIVE STRUCTURE

The Rollover Protective Structure (ROPS) on this vehicle meets OSHA 1928.53 rollover performance requirements. Always have your authorized POLARIS dealer thoroughly inspect the ROPS if it ever becomes damaged in any way.

No device can assure occupant protection in the event of a rollover. Always follow all safe operating practices outlined in this manual to avoid vehicle rollover.

WARNING

Vehicle rollover could cause severe injury or death. Always avoid operating in a manner that could result in vehicle rollover.

TRAILER HITCH BRACKET

This vehicle is equipped with a receiver hitch bracket for a trailer hitch. A hitch capacity label is located on the hitch.

To avoid injury and property damage, always heed the warnings and towing capacities outlined on page 50.

FUEL CAP

NOTICE

Never use fuel blends with more than 10% ethanol. Engine damage could occur.

The fuel tank filler cap ① is located on the right side of the vehicle near the passenger seat. Use only unleaded gasoline with a minimum pump octane number of 87 R+M/2 octane. Unleaded fuel blends with up to 10% ethanol can be used.

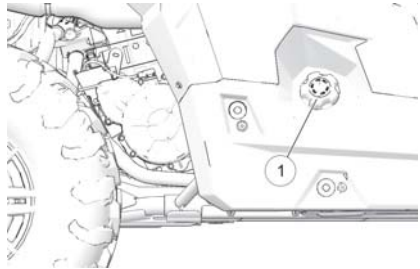

HOOD

Remove the hood to access the radiator pressure cap and coolant overflow bottle.

CAUTION

Escaping steam can cause burns. Never remove the pressure cap while the engine is warm or hot. Always allow the engine to cool before removing the pressure cap.

To remove the hood, do the following:

1. Turn the hood fasteners ② 1/4 turn.
2. Grasp the upper hood edge and pull upward to disengage the fasteners.
3. Pivot the hood forward and lift upward to disengage the lower hood hooks.
4. Lift the hood away from the vehicle.

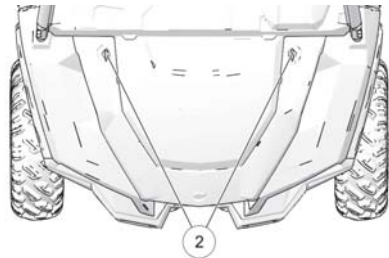

CAB DOORS

This vehicle is equipped with cab doors. Riding in this vehicle without closed and latched cab doors increases the risk of serious injury or death in the event of an accident or rollover. Always make sure all cab doors are closed and latched when riding in this vehicle.

Always inspect doors and latches for wear and damage before each use of the vehicle.

Promptly replace any worn or damaged parts with new parts available from your authorized POLARIS dealer.

INSTRUMENT CLUSTER

NOTICE

High water pressure may damage components. Wash the vehicle by hand or with a garden hose using mild soap. Certain products, including insect repellents and chemicals, will damage the speedometer lens and other plastic surfaces. Do not use alcohol to clean the instrument cluster. Do not allow insect sprays to contact the lens. Immediately clean off any gasoline that splashes on the instrument cluster.



- | | |
|-------------------|----------------------------|
| ① Speedometer | ④ Mode Button |
| ② Tachometer | ⑤ Toggle Buttons |
| ③ Indicator Lamps | ⑥ Rider Information Center |

FEATURES AND CONTROLS

SPEEDOMETER

The speedometer displays vehicle speed in either miles per hour (MPH) or kilometers per hour (km/h). See page 42.

TACHOMETER

The tachometer displays engine speed in revolutions per minute (RPM).

MODE BUTTON

Press and hold the MODE button ④ to enter or exit the settings menu. Press and release the MODE button to cycle through Area 1 modes and to select an item.









TOGGLE BUTTONS

Press and release either toggle button ⑤ to cycle through the options menu or Area 2 modes. Press and hold either toggle button to reset an item. See page 40.

TIP

With the ignition key off, pressing the MODE button or either toggle button will power up the Rider Information Center for 10 seconds to allow viewing of the odometer and the clock.

INDICATOR LAMPS

LAMP	INDICATES	CONDITION
MPH	Vehicle Speed	When standard mode is selected, speed displays in miles per hour.
km/h		When metric mode is selected, speed displays in kilometers per hour.
	Over Temperature	This lamp illuminates to indicate an overheated engine. If the indicator flashes, the overheating condition remains, and the system will automatically reduce engine power.
	Electric Power Steering (EPS) Warning (if equipped)	This indicator illuminates briefly when the key is turned to the ON position. If the light remains on, the EPS system is inoperative. Your dealer can assist.
N	Neutral	This lamp illuminates when the transmission is in neutral and the ignition key is in the ON position.
	High Beam	This lamp illuminates when the headlamp switch is set to high beam.
	Helmet/Seat Belt	This lamp is a reminder to the operator to ensure all riders are wearing helmets and seat belts before operating. The driver's seat belt is equipped with a seat belt interlock. Vehicle speed will be limited to 15 MPH (24 km/h) if the seat belt is not secured.
	Check Engine	This indicator appears if an Electronic Fuel Injection (EFI) related fault occurs. Do not operate the vehicle if this warning appears. Serious engine damage could result. Your dealer can assist.
	Check Battery	This warning usually indicates that the vehicle is operating at an RPM too low to keep the battery charged. It may also occur when the engine is at idle and high electrical load (lights, cooling fan, accessories) is applied. Drive at a higher RPM or recharge the battery to clear the warning.
	Low Fuel	This lamp illuminates when fuel level in the fuel tank is low.
	Speed Key (optional accessory)	Information about the speed key is provided in the accessory kit.

FEATURES AND CONTROLS

RIDER INFORMATION CENTER

The rider information center is located in the instrument cluster. All segments will light up for one second at start-up. If the instrument cluster fails to illuminate, a battery over-voltage may have occurred and the instrument cluster may have shut off to protect the electronic speedometer. If this occurs, your POLARIS dealer can provide proper diagnosis.

The information center is set to display standard units of measurement and a 12-hour clock at the factory. To change to metric and/or a 24-hour clock.

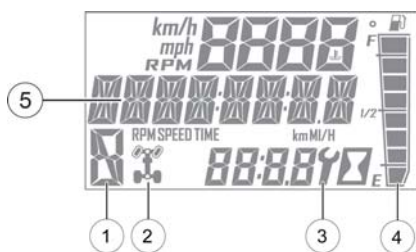

①	Gear Indicator	This indicator displays gear shifter position .H = High Gear L = Low Gear N = Neutral R = Reverse Gear P = Park - = Gear Signal Error (or shifter between gears)
②	AWD Indicator	This indicator shows whether 2X4 or 4X4 is active.
③	Service Indicator	A flashing wrench symbol alerts the operator that the preset service interval has been reached. Your POLARIS dealer can provide scheduled maintenance. See page 42 for resetting instructions.
④	Fuel Gauge	The segments of the fuel gauge show the level of fuel in the fuel tank. When the last segment clears, a low fuel warning is activated. The outline of the fuel display will flash. Refuel immediately.
⑤	Speed Limitation (if equipped)	This vehicle may be equipped with a maximum speed limitation function. This would be displayed on the screen as "LIM" followed by the speed. "LIM 30" for example.

MODE INFORMATION DISPLAYS

The rider information center contains three areas that display mode information.



① Area 1 Modes	Description
Engine Temperature	Temperature of engine coolant
Vehicle Speed	Speed of vehicle
Tachometer	Engine speed (RPM)
② Area 2 Modes	Description
Odometer	The odometer records and displays the distance traveled by the vehicle.
Trip Meters (T1/T2)	A trip meter records the distance traveled by the vehicle if reset before each trip. To reset, see page 42.
Engine Hours	Total hours of engine operation since manufacture
Service Hours	A flashing wrench symbol indicates that the preset service interval has been reached. To reset, see page 42.
Trip Time	Time length of vehicle operation since mode was last reset
③ Area 3 Modes	Description
Clock	The clock displays time in a 12-hour or 24-hour format. To reset, see page 41.

FEATURES AND CONTROLS

ACCESSING MENUS AND OPTIONS

GAUGE SETTINGS MENU

Press and release the MODE button to cycle through the Area 1 modes until the desired default mode displays. See page 39.

Press and hold the MODE button to enter the settings menu.

The OPTIONS screen will display for a few seconds.

1. Press and release either toggle button to cycle to the desired option.
2. Press MODE to select the option.
3. Press either toggle button to cycle to the desired setting.
4. Press MODE to save and exit to the settings menu.
5. Press and hold the MODE button to exit the settings menu.



BACKLIGHT COLOR

The information center backlight can be set to either blue or red.

1. Press and hold the MODE button to enter the settings menu.
2. Press either toggle button to cycle to the "BL COLOR" option. Press MODE to select.
3. Press either toggle button to cycle to the desired setting.
4. Press MODE to save and exit to the settings menu,



BACKLIGHT BRIGHTNESS

The information center backlight can be set to either blue or red.

1. Press and hold the MODE button to enter the settings menu.
2. Press either toggle button to cycle to the “BL LEVEL” option. Press MODE to select.
3. Press “UP” button to increase brightness. Press “DOWN” button to decrease brightness.
4. Press MODE to select and exit to the settings menu.



CLOCK

The clock must be reset any time the battery has been disconnected or discharged.

1. Press and hold the MODE button to enter the settings menu.
2. Press either toggle button to cycle to the “CLOCK” option. Press MODE to select.
3. Press either toggle button to cycle to the desired setting (12H or 24H). Press MODE to select.
4. Press either toggle button to change each segment of the clock. Press MODE to accept a change and advance to the next segment.



FEATURES AND CONTROLS

DISPLAY UNITS (STANDARD/METRIC)



1. Press and hold the MODE button to enter the settings menu.
2. Press either toggle button to cycle to the desired “UNITS” option (distance, temperature or volume). Press MODE to select.
3. Press either toggle button to cycle to the desired setting.
4. Press MODE to save and exit to the settings menu.

TRIP METER

Use a trip meter to track the distance traveled during a specific trip or period of time. Reset the meter to zero before traveling.

1. Press either toggle button to cycle to the desired trip meter option (T1 or T2).
2. Press and hold either toggle button until the meter resets to zero.



TRIP TIME

Use a trip time meter to track the travel time during a specific trip. Reset the meter to zero before traveling.

1. Press either toggle button to cycle to the trip time option (TT).
2. Press and hold either toggle button until the meter resets to zero.



PROGRAMMABLE SERVICE INTERVAL

The service interval counter is programmed to 25 hours at the factory. As hours of engine operation increase, the counter decreases. The wrench icon will flash for about 10 seconds when the counter reaches zero (0), and each time the key is turned on thereafter, until the counter is reset.

When this feature is enabled, it provides a convenient reminder to perform routine maintenance. Refer to the Periodic Maintenance Chart for recommended service intervals.

Use the following procedure to reset or change the service interval.

1. Press and hold the MODE button to enter the settings menu.
2. Press either toggle button to cycle to the “Service Hours” option. Press MODE to select.
3. Press MODE to reset the existing value and exit, or press either toggle button to change the value. Press MODE to save and exit to the settings menu.



ENGINE ERROR CODES

The error screen displays only when the CHECK ENGINE indicator is on or when it goes on and off during one ignition cycle. Error codes are not stored. When the key is turned OFF, the code and message is lost, but will reappear if the fault reoccurs after restarting the engine.

If the CHECK ENGINE lamp or the EPS lamp illuminates, retrieve the active error codes from the display.

- ① Failure Mode Indicator (FMI)
- ② Suspect Parameter Number (SPN)
- ③ Code Count

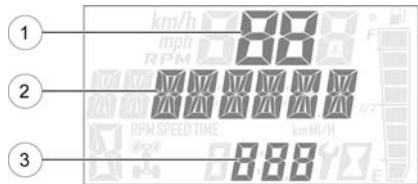

1. Press and hold the MODE button to enter the settings menu.
2. Press either toggle button to cycle to the “DIAGCODE” option. Press MODE to select.
3. More than one diagnostic code may be present. Press the toggle UP button to see if more codes are present. Press MODE to select a code.

NOTE

If the displayed code is an engine fault code, the CHECK ENGINE lamp will blink. If the displayed code is an EPS fault code, the EPS lamp will blink.

4. Record the three (3) numbers displayed.
5. Press MODE to exit to the settings menu.

OPERATION

WARNING

Failure to operate the vehicle properly can result in a collision, loss of control, accident or rollover, which may result in serious injury or death. Read and understand all safety warnings outlined in the safety section of this owner's manual.

VEHICLE BREAK-IN PERIOD

The break-in period for your new vehicle is the first 20 hours of operation, or the time it takes to use the first 2 tanks full of gasoline. No single action on your part is as important as a proper break-in period. Careful treatment of a new engine will result in more efficient performance and longer life for the engine. Perform the following procedures carefully.

NOTICE

Excessive heat build-up during the first 3 hours of operation will damage close-fitted engine parts and drive components. Do not operate at full throttle or high speeds during the first 3 hours of use.

ENGINE AND DRIVETRAIN BREAK-IN

1. Fill the fuel tank with clean, fresh fuel. Review the fuel warnings in the Refueling section.
2. Check the oil level. Add the recommended oil as needed to maintain the oil level in the normal (safe) operating range.
3. Drive slowly at first. Select an open area that allows room to familiarize yourself with vehicle operation and handling.
4. Vary throttle positions. Do not operate at sustained idle.
5. Perform regular checks on fluid levels, controls and areas outlined on the daily pre-ride inspection checklist.
During the break-in period, change both the oil and the filter at 25 hours.
6. Check fluid levels of transmission and all gearcases after the first 25 hours of operation and every 100 hours thereafter.
7. Pull only light loads.

OPERATION

PVT BREAK-IN (CLUTCHES/BELT)

A proper break-in of the clutches and drive belt will ensure a longer life and better performance. Break in the clutches and belt by operating at slower speeds during the break-in period as recommended. Pull only light loads. Avoid aggressive acceleration and high speed operation during the break-in period.

If a belt fails, always clean any debris from the PVT intake and outlet duct and from the clutch and engine compartments when replacing the belt.

STARTING THE ENGINE

1. Always start the engine outdoors or in a well-ventilated area.
2. Sit in the driver's seat and fasten the seat belt. Always make sure all cab doors are closed and latched when riding in this vehicle.
3. Place the transmission in PARK.
4. Apply the brakes. Do not press the throttle pedal while starting the engine.
5. Turn the ignition key past the ON/RUN position to START. Engage the starter for a maximum of five seconds. Release the key when the engine starts.
6. If the engine does not start within five seconds, release the ignition switch and wait five seconds. Repeat steps 5 and 6 until the engine starts.

STOPPING THE ENGINE

1. Release the throttle pedal completely and brake to a complete stop.
2. Place the transmission in PARK.
3. Turn the engine off.
4. Slowly release the brake pedal and make sure the transmission is in PARK before exiting the vehicle.

WARNING

A rolling vehicle can cause serious injury. Always place the transmission in PARK when stopping the engine.

BRAKING

1. Release the throttle pedal completely. (When the throttle pedal is released completely and engine speed slows to near idle, the vehicle has no engine braking.)
2. Press on the brake pedal evenly and firmly. Practice starting and stopping (using the brakes) until you're familiar with the controls.

PRE-RIDE INSPECTION

Failure to inspect and verify that the vehicle is in safe operating condition before operating increases the risk of an accident. Always inspect the vehicle before each use to make sure it's in safe operating condition.

ITEM	REMARKS	PAGE
Brake System/Pedal Travel	Ensure proper operation	page 90
Brake Fluid	Ensure proper level	page 91
Front Suspension	Inspect, lubricate if necessary	page 77
Rear Suspension	Inspect, lubricate if necessary	page 77
Steering	Ensure free operation	page 88
Tires	Inspect condition and pressure	page 94
Wheels/Fasteners	Inspect, ensure fastener tightness	page 94
Frame Nuts, Bolts, Fasteners	Inspect, ensure tightness	-
Fuel and oil	Ensure proper levels	page 78
Coolant Level	Ensure proper level	page 84
Coolant Hoses	Inspect for leaks	-
Throttle Pedal	Ensure proper operation	-
Indicator Lights/Switches	Ensure proper operation	page 27
Intake Screen	Inspect, clean	page 89
Air Filter	Inspect, clean	page 89
Headlamp	Verify proper operation	-
Brake Light/Tail Lamp	Verify proper operation	-
Seat Belt	Check length of belt for damage, check latches for proper operation	page 30
Cab Doors	Check doors and latches for wear or damage.	-

ALL WHEEL DRIVE/REAR DIFFERENTIAL SYSTEM

If your model is equipped with a lockable differential, you can choose to operate with an open differential or a closed differential.

ENGAGING AWD

OPERATION

Press the top of the switch to engage All Wheel Drive (AWD). The 4X4 indicator illuminates in the rider information center to indicate that the vehicle is in AWD.

When the AWD switch is on, the front gearcase will automatically engage any time the rear wheels lose traction. When the rear wheels regain traction, the front gearcase will automatically disengage. There is no limit to the length of time the vehicle may remain in AWD.

Initially, the vehicle's electronic system will not enable the AWD until the engine RPM is below 3100. Once enabled, the AWD remains enabled until the AWD switch is turned off. If the switch is turned off while the front gearcase is moving, it will not disengage until the rear wheels regain traction.

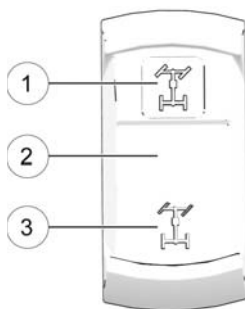

- ① All-Wheel Drive (AWD)
- ② Differential Lock
- ③ Differential Unlock

Engage the AWD before getting into conditions where front wheel drive may be needed. If the rear wheels are spinning, release the throttle before switching to AWD.

NOTICE

Switching to AWD while the rear wheels are spinning may cause severe drive shaft and clutch damage. Always switch to AWD while the rear wheels have traction or are at rest.

DISENGAGING AWD

Move the AWD switch to the center or bottom position to disengage AWD. If the switch is turned off while the front hubs are driving, they will not release until the rear wheels regain traction.

In some situations, the front gearcase may remain locked after turning the AWD switch off. If this occurs, you may notice increased steering effort and some vehicle speed restriction. Perform the following procedure to unlock the front gearcase.

To disengage AWD, do the following:

1. Stop the vehicle.
2. Operate in reverse for at least 10 feet (3 m).
3. Stop completely.
4. Shift into low gear and drive forward.
5. If the front gearcase remains locked after following these instructions, see your dealer or other qualified service person for service.

LOCKING THE DIFFERENTIAL

Move the rocker switch to the center position to lock the differential and operate in two wheel drive (2WD). Locking the differential in slippery or low traction conditions helps improve traction. When the rear differential is locked, both rear wheels rotate at the same speed.

UNLOCKING THE DIFFERENTIAL (TURF MODE)

When operating in TURF mode, the inside rear wheel will rotate independently from the outside wheel during turns. Operate in TURF mode only as needed to protect smooth, level surfaces from tire damage. DO NOT operate in TURF mode when climbing or descending hills, when sidehilling, or when operating on uneven, loose, or slippery terrain such as sand, gravel, ice, snow, obstacles, and water crossings. Always operate in AWD on these types of terrain.

WARNING

Operating in TURF mode (if equipped) when on sloped, uneven, or loose terrain could cause loss of control and result in serious injury or death. One rear wheel may slip and lose traction or may lift up and grab when it touches the ground again.

Press the bottom of the switch to unlock the differential and allow the rear drive wheels to operate independently (1WD). When the rear differential is unlocked, the rear wheels can rotate at different speeds. Unlock the differential to make maneuvering easier and minimize damage to turf.

NOTICE

Damage to the differential can occur if it is engaged while the vehicle is traveling at high speeds or while the rear wheels are spinning. Slow the vehicle to nearly stopped before engaging the differential.

WARNING

Never operate in TURF mode (if equipped) while operating on a hill or other irregular terrain. Always move the AWD switch to AWD before ascending or descending a hill.

HAULING CARGO

WARNING

Hauling cargo improperly can alter vehicle handling and may cause loss of control or brake instability, which can result in serious injury or death.

Always follow these precautions when hauling cargo:

- Never exceed the maximum weight capacity of the vehicle. When determining the weight you are adding to the vehicle, include the weight of the operator, passengers, non-factory installed accessories, loads in the rack or box and the load on the trailer tongue. The combined weight of these items must not exceed the maximum weight capacity.
- **REDUCE SPEED AND ALLOW GREATER DISTANCES FOR BRAKING WHEN HAULING CARGO.**
- Always load the cargo box with the load as far forward and as low as possible.
- When operating over rough or hilly terrain, reduce speed and cargo to maintain stable driving conditions.
- Always operate the vehicle with extreme care when hauling or towing loads.
- Slow down and drive in the lowest gear available. When transporting heavy loads and/or when towing, always operate the vehicle in low gear and have ADC activated (if equipped).
- **SECURE ALL LOADS BEFORE OPERATING.** Unsecured loads can create unstable operating conditions, which could result in loss of control of the vehicle.
- **OPERATE ONLY WITH STABLE AND SAFELY ARRANGED LOADS.** When handling off-centered loads that cannot be centered, securely fasten the load and operate with extra caution. Always attach the tow load to the hitch point designated for your vehicle.
- **HEAVY LOADS CAN CAUSE BRAKING AND CONTROL PROBLEMS.** Use extreme caution when applying brakes with a loaded vehicle. Avoid terrain or situations that may require backing downhill.
- **USE EXTREME CAUTION** when operating with loads that extend over the rack sides. Stability and maneuverability may be adversely affected, causing vehicle rollover.
- **DO NOT TRAVEL FASTER THAN THE RECOMMENDED SPEEDS.** Vehicle should never exceed 10 MPH (16 km/h) while towing a load on a level grass surface. Vehicle speed should never exceed 5 MPH (8 km/h) when towing loads in rough terrain, while cornering, or while ascending or descending an incline.

Your POLARIS vehicle has been designed to carry or tow specific capacities. Always read and understand the load distribution warnings listed on the warning labels. The total load (operator, passengers, non-factory installed accessories, cargo and weight on hitch) must not exceed the maximum weight capacity of the vehicle. See the Safety chapter for details.

⚠ WARNING

Driving with passengers in the cargo box can result in severe injury or death. Never allow passengers to ride in the cargo box. Passengers must always ride in the cab with seat belts fastened securely.

TOWING LOADS

Towing improperly can alter vehicle handling and may cause loss of control or brake instability. Always follow these precautions when towing:

1. Never load more than 150 lbs. (68.1 kg) tongue weight on the towing bracket.
2. When transporting heavy loads and/or when towing, always operate the vehicle in low gear and have ADC activated (if equipped).
3. Do not operate the vehicle faster than 10 MPH (16 km/h) when towing. Towing a trailer increases braking distance.
4. Do not tow more than the recommended weight for the vehicle. See the towing capacity chart below and the Specifications section for towing values.
5. Attach a trailer to the trailer hitch bracket only. Do not attach a trailer to any other location, which could result in loss of control of the vehicle.
6. Avoid towing loads on an incline. If it's unavoidable, choose the smallest incline available, operate with extreme caution, and drive straight up or down the incline.

TOTAL TOWED LOAD WEIGHT (LEVEL GROUND)	TOTAL HITCH VERTICAL WEIGHT	MAXIMUM TOWING SPEED
1,500 lbs. (680 kg)	150 lbs. (68.1 kg)	10 MPH (16 km/h)

NOTE

To extend belt life, use low gear when hauling or towing heavy cargo.

OPERATION

BELT LIFE

To extend belt life, use low gear when hauling or towing heavy cargo.

DUMPING THE CARGO BOX

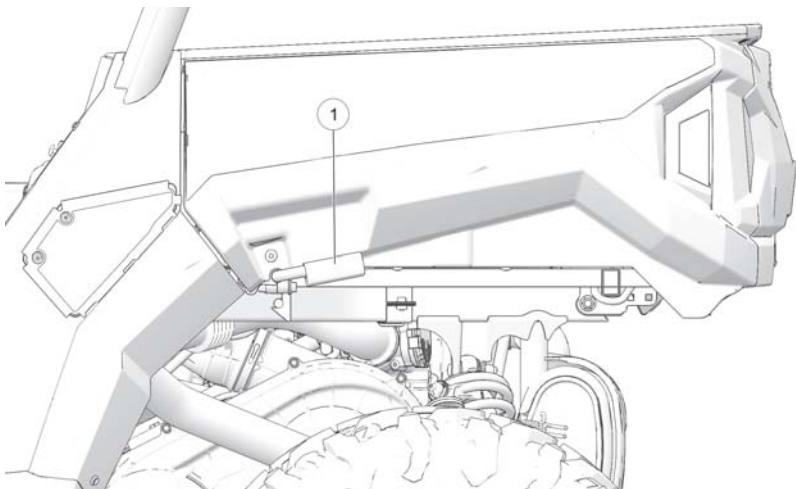

1. Select a level site to dump the cargo box. Do not attempt to dump or unload the vehicle while parked on an incline.
2. Apply the brakes. Place the transmission in PARK.
3. Ensure that the cargo is positioned evenly or toward the front of the cargo box.
4. Release the tailgate by pulling up on the tailgate latch.

WARNING

If the weight distribution on the box is located toward the rear of the box when the release lever is pulled forward, the box may dump unexpectedly and cause serious injury to the operator or bystanders. Never operate the dump lever without ensuring that the load is positioned evenly or at the front of the box.

5. Stand clear and pull one of the cargo box release levers upward. Lift the front of the cargo box to dump the cargo.
6. Lower the cargo box and push down securely to latch.

⚠ WARNING

Operating the vehicle while the cargo box is raised could result in severe injury. The box could close unexpectedly and cause injury to the driver or passenger.

The rear tires could also catch the rear of a raised box, damaging the vehicle and creating hazardous driving conditions. Never operate this vehicle with the cargo box in the raised position.

TOWING THE GENERAL

Towing this vehicle is not recommended. Always transport the vehicle on a trailer or flatbed with all four wheels off the ground. See page 103.

If towing a disabled vehicle is unavoidable, place the disabled vehicle's transmission in neutral. Tow the shortest distance possible. Do not operate faster than 10 MPH (16 km/h).

DRIVING PROCEDURE

1. Wear a helmet, eye protection, gloves, long-sleeve shirt, long pants and over-the-ankle boots.
2. Perform the pre-ride inspection. See the Pre-Ride Inspection section for details.
3. Sit in the driver's seat and fasten the seat belt.
4. Always make sure all cab doors are closed and latched when riding in this vehicle.
5. Place the transmission in PARK.
6. Start the engine.
7. Apply the service brakes and shift the transmission into gear.
8. Check your surroundings and determine your path of travel.
9. Release the parking brake (if equipped).
10. Keeping both hands on the steering wheel, slowly release the brakes and slowly depress the throttle with your right foot to begin driving.
11. Drive slowly. Practice maneuvering and using the throttle and brakes on level surfaces.
12. Do not carry a passenger until you have at least two hours of driving experience with this vehicle.

OPERATION

DRIVING WITH A PASSENGER

1. Perform the pre-ride inspection.
2. Make sure all passengers are at least 12 years of age and tall enough to comfortably and safely sit in a passenger seat with the seat belt secured, put both feet on the floor and grasp the hand hold.
3. Make sure all passengers are wearing helmet, eye protection, gloves, long-sleeve shirt, long pants and over-the-ankle boots.
4. Make sure all passengers secure their seat belt.
5. Make sure all cab nets (or doors) are properly secured.
6. Do not carry more than the recommended number of passengers for your vehicle.
7. Allow a passenger to ride only in a passenger seat.
8. Slow down. Always travel at a speed appropriate for your skills, your passengers' skills, and operating conditions. Avoid unexpected or aggressive maneuvers that could cause discomfort or injury to a passenger.
9. Vehicle handling may change with a passenger and/or cargo on board. Allow more time and distance for braking.
10. Always follow all operating guidelines as outlined on safety labels and in this manual.

DRIVING OVER OBSTACLES

Follow these precautions when operating over obstacles:

1. Always check for obstacles before operating in a new area.
2. Look ahead and learn to read the terrain. Be constantly alert for hazards such as logs, rocks and low hanging branches.
3. Travel slowly and use extra caution when operating on unfamiliar terrain. Not all obstacles are immediately visible.
4. Avoid operating over large obstacles such as large rocks and fallen trees. If unavoidable, use extreme caution and operate slowly.
5. Always have all passengers dismount and move away from the vehicle before operating over an obstacle that could cause a rollover.

DRIVING ON SLIPPERY SURFACES

⚠ WARNING

Skidding or sliding can cause loss of control or rollover (if tires regain traction unexpectedly). When operating on slippery surfaces such as ice or loose gravel, reduce speed and use extra caution to reduce the chance of skidding or sliding out of control. Do not operate on excessively slippery surfaces.

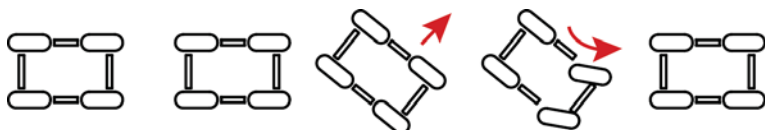

When driving on slippery surfaces such as wet trails, loose gravel, or ice, be alert for the possibility of skidding and sliding. Follow these precautions when encountering slippery conditions:

1. Do not operate on excessively rough, slippery or loose terrain.
2. Slow down before entering slippery areas.
3. Maintain a high level of alertness, reading the trail and avoiding quick, sharp turns, which can cause skids.
4. Engage all-wheel drive before wheels begin to lose traction.

NOTICE

Severe damage to the drive train may occur if the AWD is engaged while the wheels are spinning. Always allow the wheels to stop spinning before engaging AWD.

5. Correct a skid by turning the steering wheel in the direction of the skid. *Never apply the brakes during a skid.*

DRIVING UPHILL

Whenever traveling uphill, follow these precautions:

1. Avoid excessively steep hills.
2. ADC Models: Always operate in low gear and engage ADC 4X4 before ascending or descending a hill.
3. Always travel straight uphill.
4. Keep both feet on the floor.
5. Always check the terrain carefully before ascending any hill. Never climb hills with excessively slippery or loose surfaces.
6. Proceed at a steady rate of speed and throttle opening. Never open the throttle suddenly.

OPERATION

7. Never go over the crest of a hill at high speed. An obstacle, a sharp drop, or another vehicle or person could be on the other side of the hill.

DRIVING ON A SIDEHILL

Driving on a sidehill is not recommended. Improper procedure could cause loss of control or rollover. Avoid crossing the side of any hill unless absolutely necessary.

If crossing a sidehill is *unavoidable*, follow these precautions:

1. Engage all-wheel drive
2. Drive slowly and use extreme caution.
3. If the vehicle begins to roll over, or if it feels as if it may roll over, immediately turn downhill.
4. Avoid obstacles and changes in terrain that may lower or raise one side of the vehicle or cause the vehicle to slide.
5. If the vehicle begins to slide downhill, immediately turn downhill to stop the slide, or stop the vehicle and maneuver slowly and carefully until the vehicle can be driven straight downhill.

DRIVING DOWNHILL

When driving downhill, follow these precautions:

1. Avoid excessively steep hills.
2. Always check the terrain carefully before descending a hill. Never drive on hills with excessively slippery or loose surfaces.
3. Slow down. Never travel down a hill at high speed.
4. Always descend a hill with the transmission in forward gear. *Never descend a hill with the transmission in neutral.*
5. Avoid traveling down a hill at an angle, which would cause the vehicle to lean sharply to one side. Travel straight downhill.
6. Apply the brakes *lightly* to aid in slowing.

DRIVING THROUGH WATER

Your vehicle can operate through water up to a maximum recommended depth equal to the floorboards.

NOTE

If your vehicle becomes immersed or is operated in water that exceeds the floor level, service is required before starting the engine. Your dealer can provide this service. If it's impossible to bring the vehicle in before starting the engine, perform the service outlined on page 90, and take the vehicle in for service at the first opportunity.

Follow these procedures when operating through water:

1. Determine water depths and current before entering water.
2. Choose a crossing where both banks have gradual inclines.
3. Proceed slowly, avoiding rocks and obstacles.
4. Avoid operating through deep or fast-flowing water.

⚠ WARNING

The large tires on your vehicle may cause the vehicle to float in deep or fast-flowing water, which could result in loss of control and lead to serious injury or death. Never cross deep or fast-flowing water with your vehicle

5. After leaving water, always dry the brakes by applying light pressure to the pedal repeatedly until braking action is normal.

NOTE

After running your vehicle in water, it's critical that you perform the services outlined in the Periodic Maintenance Chart section. Give special attention to engine oil, transmission oil, front and rear gearcases (if equipped), and all grease fittings.

DRIVING IN REVERSE

Follow these precautions when operating in reverse:

1. Always check for obstacles or people behind the vehicle. Always inspect left and right fields of vision before backing.
2. Always avoid backing downhill.
3. Back slowly.
4. Apply the brakes lightly for stopping.
5. Avoid turning at sharp angles.
6. Never open the throttle suddenly.

PARKING THE VEHICLE

1. Stop the vehicle on a level surface. When parking inside a garage or other structure, be sure that the structure is well ventilated and that the vehicle is not close to any source of flame or sparks, including any appliance with pilot lights.
2. Place the transmission in PARK.
3. Turn the engine off.
4. Engage the parking brake (if equipped).
5. Slowly release the brake pedal and make sure the transmission is in PARK before exiting the vehicle.

OPERATION

6. Remove the ignition key to prevent unauthorized use.

PARKING ON AN INCLINE

Avoid parking on an incline if possible. If it's unavoidable, follow these precautions:

1. Apply the brakes.
2. Place the transmission in PARK.
3. Engage the parking brake (if equipped).
4. Turn the engine off.
5. Slowly release the brake pedal and make sure the transmission is in PARK before exiting the vehicle.
6. Engage the park brake (if equipped).
7. Block the rear wheels on the downhill side.

WINCH GUIDE

These safety warnings and instructions apply if your vehicle came equipped with a winch or if you choose to add an accessory winch to your vehicle.

WARNING

Improper winch use can result in SEVERE INJURY or DEATH. Always follow all winch instructions and warnings in this manual.

Your winch may have a cable made of either wire rope or specially designed synthetic rope. The term “winch cable” will be used for either unless noted otherwise.

WINCH SAFETY PRECAUTIONS

1. Read all sections of this manual.
2. Never use alcohol or drugs before or while operating the winch.
3. Never allow children under 16 years of age to operate the winch.
4. Always wear eye protection and heavy gloves when operating the winch.
5. Always keep body, hair, clothing and jewelry clear of the winch cable, fairlead and hook when operating winch.
6. Never attempt to “jerk” a load attached to the winch with a moving vehicle. See the *Shock Loading* section on page 67.
7. Always keep the area around the vehicle, winch, winch cable, and load clear of people (especially children) and distractions while operating the winch.
8. Always turn the vehicle ignition power OFF when it and the winch are not being used.
9. Always be sure that at least five (5) full turns of winch cable are wrapped around the winch drum at all times. The friction provided by this wrapped cable allows the drum to pull on the winch cable and move the load.
10. Always apply your vehicle’s park brake and/or park mechanism to hold the vehicle in place during winching. Use wheel chocks if needed.
11. Always align the vehicle and winch with the load directly in front of the vehicle as much as possible. Avoid winching with the winch cable at an angle to the winching vehicle’s centerline whenever possible.
12. If winching at an angle is unavoidable, follow these precautions:
 - a. Look at the winch drum occasionally. Never let the winch cable “stack” or accumulate at one end of the winch drum. Too much winch cable at one end of the winch drum can damage the winch and the winch cable.
 - b. If stacking occurs, stop winching. Follow step 15 on page 60 to feed and rewind the cable evenly before continuing the winch operation.

WINCH GUIDE

13. Never winch up or down at sharp angles. This can destabilize the winching vehicle and possibly cause it to move without warning.
14. Never attempt to winch loads that weigh more than the winch's rated capacity.
15. The winch motor may become hot during winch use. If you winch for more than 45 seconds, or if the winch stalls during operation, stop winching and permit the winch to cool down for 10 minutes before using it again.
16. Never touch, push, pull or straddle the winch cable while winching a load.
17. Never let the winch cable run through your hands, even if wearing heavy gloves.



18. Never release the clutch on the winch when the winch cable is under load.
19. Never use the winch for lifting or transporting people.
20. Never use the winch to hoist or suspend a vertical load.
21. Never immerse or submerge your winch in water. Your dealer can provide service on your winch if this occurs.
22. Always inspect your winch and winch cable before each use.
23. Never winch the hook fully into the winch. This can cause damage to winch components.
24. Unplug the remote control from the vehicle when the winch is not in use to prevent inadvertent activation and use by unauthorized persons.
25. Never grease or oil the winch cable. This will cause the winch cable to collect debris that will shorten the life of the cable.

WINCH OPERATION

Read the Winch Safety Precautions in the preceding pages before using your winch.

TIP

Consider practicing the operation and use of your winch before you actually need to use it in the field.

⚠ WARNING

Improper winch use can result in SEVERE INJURY or DEATH. Always follow all winch instructions and warnings in this manual.

Each winching situation is unique.

- Take your time to think through the winching you are about to do.
 - Proceed slowly and deliberately.
 - Never hurry or rush during winching.
 - Always pay attention to your surroundings.
 - You may need to change your winching strategy if it is not working.
 - Always remember that your winch is very powerful.
 - There are simply some situations that you and your winch will not be able to deal with. Do not be afraid to ask others to help when this happens.
1. Always inspect the vehicle, winch, winch cable and winch controls for any signs of damage or parts in need of repair or replacement before each use. *Pay particular attention to the first 3 feet (1 meter) of winch cable if the winch is being used (or has been used) for lifting an accessory plow assembly.* Promptly replace any worn or damaged cable.
 2. Never operate a winch or a vehicle in need of repair or service.
 3. Always apply your vehicle's park brake and/ or park mechanism to hold the vehicle in place during winching. Use wheel chocks if needed.

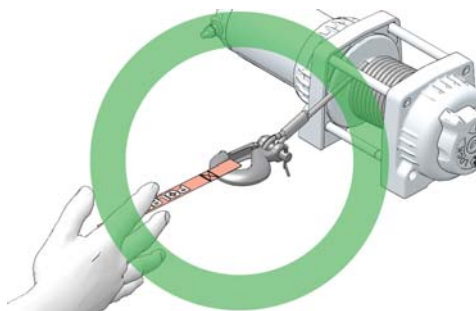

WINCH GUIDE

4. Always use the hook strap when handling the hook.

WARNING

Never put your fingers into the hook. This could lead to SEVERE INJURY.

- Attach the hook itself onto the load or use a tow strap or chain to secure the load to the winch cable.



No



Yes

TIP

A “tow strap” is NOT intended to stretch. A “recovery strap” is designed to stretch.

WARNING

Never use a recovery strap when winching due to the excessive energy that can be released if the winch cable breaks. This can result in SEVERE INJURY or DEATH. See the *Shock Loading* section on page 67.

- Never hook the winch cable back onto itself. This will damage the winch cable and may result in winch cable failure.

⚠ WARNING

Replace the winch cable at the first sign of damage to prevent SEVERE INJURY or DEATH in the event of failure. For your safety, always replace POLARIS winch parts (including the cable) with genuine POLARIS replacement parts available at your authorized POLARIS dealer.

- If possible, keep the winch cable aligned with the centerline of the winching vehicle. This will help the spooling of the winch cable and reduce the load on the fairlead.
- If freeing a stuck vehicle by attaching to a tree, use an item such as a tow strap to avoid damaging the tree during winch operation. Sharp cables and chains can damage and even kill trees. Please remember to TreadLightly® (treadlightly.org).
- Before operating the winch, be sure that the safety latch on the winch cable hook is fully seated when the load is attached.
- Never operate your winch with a damaged hook or latch. Always replace damaged parts before using the winch.

**Yes****No**

5. Never remove the hook strap from the hook.
6. Release the winch clutch and pull out the winch cable.
7. Pulling out as much cable as possible maximizes the winch's pulling capacity. Always be sure that at least five (5) full turns of winch cable are wrapped around the winch drum at all times. The friction provided by this wrapped cable allows the drum to pull on the winch cable and move the load.

WINCH GUIDE

8. Read and adhere to the following information for winch damping to ensure safe winch use.
 - a. In order to absorb energy that could be released by a winch cable failure, always place a “damper” on the winch cable. A damper can be heavy jacket, tarp, or other soft, dense object. A damper can absorb much of the energy released if a winch cable breaks when winching. Even a tree limb can help as a damper if no other items are available to you.
 - b. Lay the damper on top of the mid-point of the winch cable length that is spooled out.
 - c. On a long pull, it may be necessary to stop winching so that the damper can be repositioned to the new mid-point of the winch cable. Always release the tension on the winch cable before repositioning the damper.
 - d. Avoid being directly in line with the winch cable whenever possible. Also, never permit others to stand near or in line with the winch cable during winch operation.
9. Never hook the winch cable back onto itself. This will damage the winch cable and may result in winch cable failure.
10. Never use straps, chains or other rigging items that are damaged or worn.

11. The ONLY time a winch-equipped vehicle should be moving when using the winch is when that vehicle itself is stuck. The winch equipped vehicle should NEVER be in motion to “shock” load the winch cable in an attempt to move a second stuck vehicle. See the Shock Loading section on page 67. For your safety, always follow these guidelines when winching a vehicle free:
 - a. Release the winch clutch and spool out the necessary length of winch cable.
 - b. Align the winch cable as close as possible to the winching vehicle's centerline.
 - c. Attach the winch cable hook to the anchor point or the stuck vehicle's frame following instructions in this manual.
 - d. Re-engage the clutch on the winch.
 - e. Slowly winch in the slack in the winch cable.
 - f. Select the proper vehicle gear to propel the stuck vehicle in the direction of winching.
 - g. Shift to the lowest gear available on the stuck vehicle.
 - h. Slowly and carefully apply vehicle throttle and winch together to free the vehicle.
 - i. Stop winching as soon as the stuck vehicle is able to propel itself without the help of the winch.
 - j. Detach the winch cable hook.
 - k. Rewind the winch cable evenly back onto the winch drum following the instructions in this manual.
12. Never attempt to winch another stuck vehicle by attaching the winch cable to a suspension component, brush guard, bumper or cargo rack. Vehicle damage may result. Instead, attach the winch to a strong portion of the vehicle frame or hitch.
13. Extensive winching will run down the battery on the winching vehicle. Let the winching vehicle's engine run while operating the winch to prevent the battery from running low if winching for long periods.
14. The winch motor may become hot during winch use. If you winch for more than 45 seconds, or if the winch stalls during operation, stop winching and permit the winch to cool down for 10 minutes before using it again.

WINCH GUIDE

15. After winching is complete, especially if winching at an angle, it may be necessary to re-distribute the winch cable across the winch drum. You will need an assistant to perform this task.
 - a. Release the clutch on the winch.
 - b. Feed out the winch cable that is unevenly bunched up in one area.
 - c. Re-engage the winch clutch.
 - d. Have an assistant pull the winch cable tightly with about 100 lbs. (45 kg) of tension using the hook strap.
 - e. Slowly winch the cable in while your assistant moves the end of the winch cable back and forth horizontally to evenly distribute the winch cable on the drum.
 - f. Doing this reduces the chances of the winch cable “wedging” itself between lower layers of winch cable.

WINCH CABLE CARE

For your safety, always replace POLARIS winch parts (including the cable) with genuine POLARIS replacement parts available at your authorized POLARIS dealer.

WARNING

Use of worn or damaged cable could lead to sudden failure and SEVERE INJURY.

1. Always inspect your winch before each use. Inspect for worn or loose parts including mounting hardware. Never use the winch if any part needs repair or replacement.

- Always inspect your winch cable before each use. Inspect for worn or kinked winch cable.

A kinked winch cable made of wire rope is shown at right. Even after being “straightened out,” this cable has already been permanently and severely damaged. Promptly discontinue use of a winch cable in this condition.



A kinked winch cable made of wire rope that has been “straightened out” is shown at right. Even though it may look usable, the cable has been permanently and severely damaged. It can no longer transmit the load that it could prior to kinking. Promptly discontinue use of a winch cable in this condition.



A winch cable made of synthetic rope should be inspected for signs of fraying. Replace the cable if fraying is observed (shown at right). Promptly discontinue use of a winch cable in this condition.



Also replace the winch cable if there are fused or melted fibers. Such an area of the synthetic rope will be stiff and appear smooth or glazed. Promptly discontinue use of a winch cable in this condition.

SHOCK LOADING

WARNING

Your winch cable is very strong but it is NOT designed for dynamic, or “shock” loading. Shock loading may tension a winch cable beyond its strength and cause the cable to break. The end of a broken winch cable under such high loading can cause SEVERE INJURY or DEATH to you and other bystanders.

Winch cables are designed to NOT absorb energy. This is true of both wire-rope and synthetic-rope winch cables.

- Never attempt to “jerk” a load with the winch. For example, never take up slack in the winch cable by moving the winching vehicle in an attempt to move an object. This is a dangerous practice. It generates high winch cable loads that may exceed the strength of the cable. Even a slowly moving vehicle can create large shock loads in a winch cable.

WARNING

SEVERE INJURY or DEATH can result from a broken winch cable.

WINCH GUIDE

2. Never quickly turn the winch ON and OFF repeatedly (“jogging”). This puts extra load on the winch, winch cable, and generates excessive heat from the motor. This is a form of shock loading.
3. Never tow a vehicle or other object with your winch. Towing an object with a winch produces shock loading of the cable even when towing at slow speeds. Towing from a winch also positions the towing force high on the vehicle. This can cause instability of the vehicle and possibly lead to an accident.
4. Never use recovery straps with your winch. Recovery straps are designed to stretch and can store energy. This stored energy in the recovery strap is released if a winch cable fails making the event even more hazardous. Similarly, never use elastic “bungee” cords for winching.
5. Never use the winch to tie down a vehicle to a trailer or other transportation vehicle. This type of use also causes shock loading that can cause damage to the winch, winch cable, or vehicles used.

Your winch cable is designed and tested to withstand the loads produced by the winch motor when operated from a stationary vehicle. Always remember that the winch and winch cable are NOT designed for shock loading.

WINCH MAINTENANCE AND SERVICE SAFETY

WARNING

Improper or lack of winch maintenance and service could lead to SEVERE INJURY or DEATH. Always follow all winch instructions and warnings in this manual.

1. Always inspect your winch before each use. Inspect for worn or kinked winch cable. Also inspect for worn or loose parts including mounting hardware.
2. Permit your winch motor to cool down prior to servicing your winch.
3. Never work on your winch without first disconnecting the battery connections to prevent accidental activation of the winch.
4. For your safety, always replace POLARIS winch parts (including the cable) with genuine POLARIS replacement parts available at your authorized POLARIS dealer.
5. Some winch models use wire rope as the winch cable. Other winches use a specially designed synthetic rope as the winch cable.
6. Never replace a synthetic-rope winch cable with a consumer-grade polymer rope such as can be purchased in a hardware store. Although they may look similar, they are NOT alike. A polymer rope not designed for winch use will stretch and store excessive energy when winching.

 **WARNING**

Failure of a stretched rope under winching conditions will release all of the stored energy. This will increase the chances of SEVERE INJURY or DEATH.

EMISSION CONTROL SYSTEMS

NOISE EMISSION CONTROL SYSTEM

Do not modify the engine, intake or exhaust components, as doing so may affect compliance with U.S.A. EPA noise control requirements (40 CFR 205) and local noise level requirements.

OPERATION ON PUBLIC LANDS IN THE U.S.A.

Your vehicle has a spark arrester that was tested and qualified to be in accordance with the USFS standard 5100-1C. Federal law requires that this spark arrester be installed and functional when the vehicle is operated on public lands.

Operation of off-road vehicles on public lands in the U.S.A. is regulated by 43 CFR 420. Violations are subject to monetary penalties. Federal regulations can be viewed online at www.gpoaccess.gov/ecfr/.

CRANKCASE EMISSION CONTROL SYSTEM

This engine is equipped with a closed crankcase system. Blow-by gases are forced back to the combustion chamber by the intake system. All exhaust gases exit through the exhaust system.

EXHAUST EMISSION CONTROL SYSTEM

Exhaust emissions are controlled by engine design. An electronic fuel injection (EFI) system controls fuel delivery. The engine and EFI components are set at the factory for optimal performance and are not adjustable.

The emissions label is located on the inside of the lower left frame tube (below driver's foot area).

ELECTROMAGNETIC INTERFERENCE

This spark ignition system complies with Canadian ICES-002.

This vehicle complies with the EMC requirements of European directives 97/24/EC and 2004/108/EC.

Non-ionizing Radiation: This vehicle emits some electromagnetic energy. People with active or non-active implantable medical devices (such as heart monitoring or controlling devices) should review the limitations of their device and the applicable electromagnetic standards and directives that apply to this vehicle.

MAINTENANCE

PERIODIC MAINTENANCE CHART

Any qualified repair shop or person may maintain, replace or repair the emission control devices or systems on your vehicle. An authorized POLARIS dealer can perform any service that may be necessary for your vehicle. POLARIS also recommends POLARIS parts for emissions-related service, however equivalent parts can be used.

It is a potential violation of the Clean Air Act if a part supplied by an aftermarket parts manufacturer reduces the effectiveness of the vehicle's emission controls. Tampering with emission controls is prohibited by federal law.

Owners are responsible for performing the scheduled maintenance identified in this owner's manual.

Careful periodic maintenance will help keep your vehicle in the safest, most reliable condition. Inspection, adjustment and lubrication of important components are explained in the periodic maintenance chart.

Inspect, clean, lubricate, adjust and replace parts as necessary. When inspection reveals the need for replacement parts, genuine POLARIS parts are available from your POLARIS dealer. Equivalent parts may be used for emissions-related service.

Service and adjustments are important for proper vehicle operation. If you're not familiar with safe service and adjustment procedures, a qualified dealer can perform these operations.

Vehicles subjected to heavy or severe use patterns must be inspected and serviced more frequently.

SEVERE USE DEFINITION

- Frequent immersion in mud, water or sand
- Frequent or prolonged operation in dusty environments
- Short trip cold weather operation
- Racing or race-style high RPM use
- Prolonged low speed, heavy load operation
- Extended idle

Pay special attention to the oil level. A rise in oil level during cold weather can indicate contaminants collecting in the oil sump or crankcase. Change oil immediately if the oil level begins to rise. Monitor the oil level, and if it continues to rise, discontinue use and determine the cause. Your dealer can assist.

MAINTENANCE CHART KEY

SYMBOL	DESCRIPTION
XU	Perform these procedures more often for vehicles subjected to severe use.
D	Have an authorized POLARIS dealer or other qualified person perform these services.

MAINTENANCE

⚠ WARNING

Improperly performing the procedures marked with a **D** could result in component failure and lead to serious injury or death. Have an authorized POLARIS dealer or other qualified person perform these services.

Perform all services at whichever maintenance interval is reached first. Record maintenance and service in the Maintenance Log.

ITEM		MAINTENANCE INTERVAL (WHICHEVER COMES FIRST)			REMARKS
		HOURS	CLNDR	MILES (KM)	
	Steering	-	Pre-Ride	-	Make adjustments as needed. See the steps in the Pre-Ride Checklist section.
	Front-suspension	-	Pre-Ride	-	
	Rear-suspension	-	Pre-Ride	-	
	Tires	-	Pre-Ride	-	
	Brake fluid level	-	Pre-Ride	-	
	Brake pedal travel	-	Pre-Ride	-	
	Brake systems	-	Pre-Ride	-	
	Wheels /fasteners	-	Pre-Ride	-	
	Frame fasteners	-	Pre-Ride	-	
	Engine Oil Level	-	Pre-Ride	-	
	PVT intake screen	-	Daily	-	Inspect; clean often
	Coolant	-	Daily	-	Check level
XU	Power steering unit (if equipped)	-	Daily	-	Inspect daily; clean often
	Head lamp / tail lamp	-	Daily	-	Verify proper operation
XU	Air filter	-	Weekly	-	Inspect; replace as needed
XU D	Brake pad wear	10 H	Monthly	100 (160)	Inspect periodically
	Battery	25 H	Monthly	200 (320)	Check terminals; clean; test
	Fuel System	25 H	Monthly	200 (320)	Inspect; cycle key to pressurize fuel pump; check lines and fittings for leaks and abrasion
XU	Demand drive fluid (extreme use)	25 H	Monthly	-	Change fluid every 25 hours if ADC is subjected to extreme use. See the Front Gearcase section for details.

MAINTENANCE

ITEM		MAINTENANCE INTERVAL (WHICHEVER COMES FIRST)			REMARKS
		HOURS	CLNDR	MILES (KM)	
XU	Demand drive fluid (front gearcase) (if equipped)	25 H	Monthly	-	Perform a break-in oil level check
XU	Transmission oil	25 H	Monthly	-	Perform a break-in oil level check
XU	Engine oil change (break-in)	25 H	-	500 (800)	Perform a break-in oil change
XU	General lubrication	50 H	3 M	500 (800)	Lubricate all fittings, pivots, cables, etc.
	Shift Linkage	50 H	6 M	500 (800)	Inspect, lubricate, adjust
D	Steering	50 H	6 M	500 (800)	Lubricate
XU	Front and Rear Stabilizer Bars	50 H	6 M	500 (800)	Lubricate
D	Throttle Pedal	50 H	6 M	500 (800)	Inspect for free movement; replace pedal as needed
	Throttle body air intake ducts/flange	50 H	6 M	500 (800)	Inspect ducts for proper sealing/air leaks
	Drive belt	50 H	6 M	500 (800)	Inspect; adjust; replace as needed
	Cooling system (if applicable)	50 H	6 M	500 (800)	Inspect coolant strength seasonally; pressure test system yearly
XU	Radiator (if applicable)	50 H	6 M	500 (800)	Inspect; clean external surfaces
XU	Oil lines and fasteners	50 H	6 M	1000 (1600)	Inspect for leaks and loose fittings
XU	Engine oil and filter change	100 H	6 M	1000 (1600)	Change the oil and filter
XU	Front gearcase oil	100 H	12 M	1000 (1600)	Change fluid
XU	Transmission oil	100 H	12 M	1000 (1600)	Change fluid
D	Fuel System	100 H	12 M	1000 (1600)	Cycle key to pressurize fuel pump; check for leaks at fill cap, fuel lines/rail and fuel pump; replace lines every 2 years
XU	Cooling Hoses (if applicable)	100 H	12 M	1000 (1600)	Inspect for leaks

MAINTENANCE

ITEM		MAINTENANCE INTERVAL (WHICHEVER COMES FIRST)			REMARKS
		HOURS	CLNDR	MILES (KM)	
XU	Engine mounts	100 H	12 M	1000 (1600)	Inspect
	Exhaust muffler /pipe	100 H	12 M	1000 (1600)	Inspect
	Drive shafts	100 H	12 M	1000 (1600)	Remove and grease
D	Spark plug	100 H	12 M	1000 (1600)	Inspect; replace as needed
XU	Wiring	100 H	12 M	1000 (1600)	Inspect for wear, routing, security; apply dielectric grease to connectors subjected to water, mud, etc.
D XU	Clutches (drive and driven)	100 H	12 M	1000 (1600)	Inspect; clean; replace worn parts
D	Front wheel bearings	100 H	12 M	1000 (1600)	Inspect; replace as needed
D	Brake fluid	200 H	24 M	2000 (3200)	Change every two years
	Ratcheting cam chain tensioner	200 H	-	2000 (3200)	Check; adjust as needed
	Suspension bushings	250 H	24 M	2000 (3200)	Inspect; replace if necessary
	Spark arrester	300 H	36 M	3000 (4800)	Clean out
D	Valve clearance	-	-	5000 (8000)	Inspect; adjust as needed
XU	Coolant	-	60 M	-	Change coolant
D	Toe adjustment	-			Inspect periodically; adjust when parts are replaced
D XU	Auxiliary brake (if equipped)	-			Inspect daily; adjust as needed
	Headlight aim	-			Adjust as needed

LUBRICATION RECOMMENDATIONS

Check and lubricate all components at the intervals outlined in the Periodic Maintenance Chart section, or more often under severe use, such as wet or dusty conditions. Items not listed in the chart should be lubricated at the general lubrication interval.

ITEM	LUBE	METHOD
Engine Oil	PS-4 5W-50 4-Cycle Oil	Add to proper level on dipstick. See page 78.
Brake Fluid	DOT 4 Brake Fluid	Maintain level between fill lines. See page 91.
Main Gearcase Oil (Transmission)	AGL Gearcase Lubricant & Transmission Fluid	See page 80.
Front Gearcase Oil	Demand Drive Fluid	See page 80 and page 82.
Front Prop Shaft Yoke	U-Joint Grease	Locate fittings and grease (3 pumps maximum).
Front and Rear Stabilizer Bar Bushings	All Season Grease or grease conforming to NLGI No. 2	Grease one fitting on each side of the vehicle.

ENGINE OIL

Always check and change the oil at the intervals outlined in the Periodic Maintenance Chart. Always use the recommended engine oil. Always change the oil filter whenever changing oil.

WARNING

Vehicle operation with insufficient, deteriorated, or contaminated engine oil will cause accelerated wear and may result in engine seizure, accident and injury. Always perform the maintenance procedures as outlined in the Periodic Maintenance Chart.

OIL RECOMMENDATIONS

POLARIS recommends the use of POLARIS PS-4 5W-50 4-Cycle Oil or a similar oil. Refer to the Specifications section for capacities.

Oil may need to be changed more frequently if POLARIS PS-4 engine oil is not used. Follow the manufacturer's recommendations for ambient temperature operation. See the Polaris Products section for part numbers.

NOTICE

Mixing brands or using a non-recommended oil may cause serious engine damage. Always use the recommended oil. Never substitute or mix oil brands.

MAINTENANCE

OIL CHECK

Always check the oil when the engine is cold. If the engine is hot when the oil is checked, the level will appear to be overfull.

CAUTION

Always remove all cargo from the cargo box before lifting the box to access engine components.

Access the oil fill cap, dipstick and filter under the cargo box.

1. Remove all cargo from the cargo box. See page 52.
2. Position the vehicle on a level surface.
3. Place the transmission in PARK.
4. Stop the engine.
5. Stand clear and pull up on the cargo box release lever. Lift the front of the cargo box.
6. Remove the dipstick. Wipe it dry with a clean cloth.
7. Reinstall the dipstick completely. Remove the dipstick ① and check the oil level.
8. Remove the oil fill cap ② to add the recommended oil as needed. Maintain the oil level between the minimum and maximum marks on the dipstick. Do not overfill.
9. Reinstall the fill cap . Reinstall the dipstick.
10. Lower the cargo box and push down securely to latch.



OIL AND FILTER CHANGE

Always change the oil and filters at the intervals outlined in the Periodic Maintenance Chart section. Always change the oil filter whenever changing oil.

The crankcase drain plug is located on the bottom of the crankcase. Access the drain plug through the access hole in the skid plate under the crankcase (see next page).

CAUTION

Always remove all cargo from the cargo box before lifting the box to access engine components.

Access the oil fill cap, dipstick and filter under the cargo box.

1. Remove all cargo from the cargo box. See page 52.
2. Position the vehicle on a level surface.
3. Place the transmission in PARK.
4. Stand clear and pull up on the cargo box release lever. Lift the front of the cargo box.
5. For maximum clearance in the engine compartment, detach the cargo box shock from the base of the box.
6. Carefully detach the fuel line and spark plug wires from their retaining clips on the outlet hose, then loosen the outlet hose clamp and remove the hose from the clutch cover.

CAUTION

Do not allow debris or other objects to enter the clutch cover.

7. Locate the crankcase drain plug access hole in the skid plate.
8. Clean the area around the crankcase drain plug.

CAUTION

Hot oil can cause burns to skin. Do not allow hot oil to contact skin.

9. Place a drain pan under the engine crankcase and remove the drain plug. Allow the oil to drain completely.
10. Using an oil filter wrench, turn the filter counter-clockwise to remove it.
11. Using a clean dry cloth, clean the filter sealing surface on the crankcase.
12. Lubricate the o-ring on the new filter with a film of fresh engine oil. Check to make sure the o-ring is in good condition.
13. Install the new filter and turn by hand until the filter gasket contacts the sealing surface, then turn an additional 1/2 turn.
14. Reinstall the drain plug. Torque the drain plug to 12 ft-lbs (16 Nm).
15. Remove the oil fill cap and add 2.5 quarts (2.4 l) of recommended oil. Reinstall the fill cap.
16. Start the engine and check for leaks.
17. Stop the engine and wait 15 seconds before removing the dipstick.
18. Remove the dipstick. Wipe it dry with a clean cloth.

MAINTENANCE

19. Reinstall the dipstick completely. Remove the dipstick and check the oil level.
20. Remove the oil fill cap and add oil as needed to bring the level to the upper mark on the dipstick. Do not overfill.
21. Reinstall the fill cap. Reinstall the dipstick.
22. Reinstall the outlet hose to the clutch box, routing the hose under the fuel line and spark plug wires. Make sure the clutch cover rib aligns in the notch at the end of the outlet hose. Tighten the clamp.
23. Reinstall the fuel line and spark plug wires to the retaining clips on the outlet hose.
24. Lower the cargo box and push down securely to latch.
25. Dispose of used filter and oil properly.

GEARCASES

GEARCASE SPECIFICATION CHART

GEARCASE	LUBRICANT	CAPACITY	FILL PLUG TORQUE	DRAIN PLUG TORQUE
Main Gearcase (Transmission)	AGL Gearcase Lubricant & Transmission Fluid	44 oz. (1300 ml)	10-14 ft. lbs. (14-19 Nm)	10-14 ft. lbs. (14-19 Nm)
Front Gearcase	Demand Drive Fluid	7.5 oz. (222 ml)	8-10 ft. lbs. (11-14 Nm)	8-10 ft. lbs. (11-14 Nm)

TRANSMISSION (MAIN GEARCASE)

Always check and change the transmission oil at the intervals outlined in the Periodic Maintenance Chart section. Refer to the Gearcase Specifications Chart for recommended lubricants, capacities and torque specifications. See page 107 for the part numbers of POLARIS products.

OIL CHECK

The fluid check/fill plug is located on the rear of the gearcase. Maintain the oil level even with the bottom of the plug hole threads.

1. Position the vehicle on a level surface.
2. Remove the fill plug ①.
3. Check the fluid level.
4. Add the recommended fluid to the bottom of the fill plug hole. Do not overfill.
5. Reinstall the fill plug. Torque to specification.

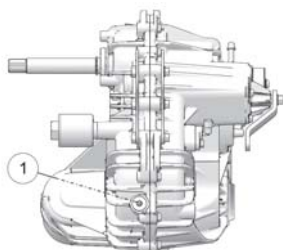

OIL CHANGE

The drain plug is located near the bottom of the gearcase.

1. Remove the fill plug ①.
2. Place a drain pan under the drain plug ②.
3. Remove the drain plug. Allow the fluid to drain completely.
4. Clean and reinstall the drain plug. Torque to specification.
5. Add the recommended fluid to the bottom of the fill plug hole. Do not overfill.
6. Reinstall the fill plug. Torque to specification.
7. Check for leaks. Discard used fluid properly.

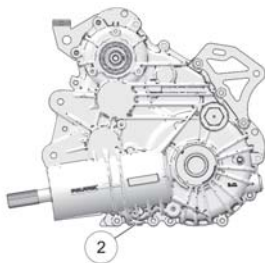

MAINTENANCE

FRONT GEARCASE

Always check and change the front gearcase oil at the intervals outlined in the Periodic Maintenance Chart. Maintain the oil level even with the bottom thread of the fill plug hole. Refer to the Gearcase Specifications Chart for recommended lubricants, capacities and torque specifications. See page 107 for the part numbers of POLARIS products.

ADC Models: Change the front gearcase fluid every 25 hours if the ADC unit is exposed to extreme use. Extreme use includes any of the following:

- Operation in ADC mode for prolonged periods.
- Constant ADC operation on hilly or mountainous terrain.
- ADC is the primary mode of all-wheel-drive operation.

TIP

If the front gearcase makes excessive noise during ADC operation, change the demand drive fluid. If the noise continues, please see your POLARIS dealer or other qualified service person for service.

OIL CHECK

The front gearcase fill plug is located on the right side of the front gearcase.

1. Position the vehicle on a level surface.
2. Place the transmission in PARK.
3. Remove the fill plug ①. Check the oil level.
4. Add the recommended oil as needed.
5. Reinstall the fill plug. Torque to specification.

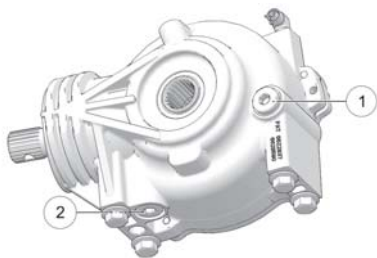

OIL CHANGE

1. Support the vehicle securely with a jackstand.
2. Remove the fill plug.
3. Place a drain pan under the drain plug.
4. Remove the drain plug. Allow the oil to drain completely.
5. Clean and reinstall the drain plug. Torque to specification.
6. Add the recommended oil.
7. Reinstall the fill plug. Torque to specification.
8. Check for leaks. Discard of used oil properly.

SPARK PLUGS

SPARK PLUG RECOMMENDATIONS

Refer to the Specifications section for the recommended spark plug type for your vehicle. Always torque spark plugs to specification.

NOTICE

Using non-recommended spark plugs can result in serious engine damage.
Always use POLARIS-recommended spark plugs or their equivalent.

SPARK PLUG GAP / TORQUE

ELECTRODE GAP	PLUG TORQUE
0.7-0.8 mm	7 ft. lbs. (9.5 Nm)

SPARK PLUG INSPECTION

Spark plug condition is indicative of engine operation. The spark plug firing end condition should be read after the engine is warmed up and the vehicle is driven at higher speeds. Immediately check the spark plug for correct color.

CAUTION

Always remove all cargo from the cargo box before lifting the box to access engine components.

1. Lift the cargo box. Remove the spark plug cap.

CAUTION

A hot exhaust system and engine can cause burns. Wear protective gloves when removing a spark plug for inspection.

2. Using the spark plug wrench provided in the tool kit, remove the plug by rotating it counter-clockwise.
3. Reverse the procedure for spark plug installation. Apply anti-seize compound to the spark plug threads.
4. Torque to specification.

NORMAL PLUG

The normal insulator tip is gray, tan or light brown. There will be few combustion deposits. The electrodes are not burned or eroded. This indicates the proper type and heat range for the engine and the service.

The tip should not be white. A white insulator tip indicates overheating, caused by use of an improper spark plug or incorrect throttle body adjustments.

MAINTENANCE

WET FOULED PLUG

The wet fouled insulator tip is black. A damp oil film covers the firing end. There may be a carbon layer over the entire nose. Generally, the electrodes are not worn. General causes of fouling are: incorrect spark plug type or heat range, excessive engine oil consumption or incorrect throttle body adjustments.

COOLING SYSTEM

The engine coolant level is controlled or maintained by the recovery system. The recovery system components are the overflow bottle, radiator filler neck, radiator pressure cap and connecting hose.

As coolant operating temperature increases, the expanding (heated) excess coolant is forced out of the radiator, past the pressure cap, and into the overflow bottle. As engine coolant temperature decreases, the contracting (cooled) coolant is drawn back up from the tank, past the pressure cap, and into the radiator.

Some coolant level drop on new vehicles is normal as the system is purging itself of trapped air. Observe coolant levels and maintain as recommended by adding coolant to the overflow bottle.

ADDING OR CHANGING COOLANT

POLARIS recommends the use of POLARIS Antifreeze 50/50 Premix. This antifreeze is already premixed and ready to use. Do not dilute with water.

To ensure that the coolant maintains its ability to protect the engine, we recommend that the system be completely drained every five (5) years and fresh Antifreeze 50/50 Premix added.

Any time the cooling system has been drained for maintenance or repair, replace the coolant with fresh Antifreeze 50/50 Premix. If the recovery bottle has run dry, the level in the radiator should be inspected. Add coolant as needed.

RADIATOR AND COOLING FAN

Always check and clean the screen and radiator fins at the intervals outlined in the Periodic Maintenance Chart. Do not obstruct or deflect air flow through the radiator by installing unauthorized accessories in front of the radiator or behind the cooling fan. Interference with the radiator air flow can lead to overheating and consequent engine damage.

NOTICE

Washing the vehicle with a high-pressure hose could damage the radiator fins and impair the radiator's effectiveness. Using a high-pressure system is not recommended.

OVERFLOW BOTTLE COOLANT LEVEL

Always check and change the coolant at the intervals outlined in the Periodic Maintenance Chart. Maintain the coolant level between the minimum and maximum marks on the bottle (when the fluid is cool).

1. Position the vehicle on a level surface.
2. Place the transmission in PARK.
3. Remove the hood. See page 33.
4. View the coolant level in the overflow bottle.
5. If the coolant level is below the safe operating range, make sure the pressure cap is securely installed before adding coolant to the overflow bottle.

NOTE

Always add coolant through the bottle filler opening, not through the radiator pressure cap opening.

6. Reinstall the coolant bottle cap.

TIP

If coolant must be added often, or if the overflow bottle runs completely dry, there may be a leak in the system. Your POLARIS dealer can inspect the cooling system.

RADIATOR COOLANT LEVEL

Check the radiator coolant level **ONLY** if the overflow bottle is dry. If the overflow bottle contains fluid, the radiator level should **NOT** be inspected.

TIP

If the overflow bottle runs completely dry, there may be a leak in the system. Your POLARIS dealer can inspect the cooling system.

1. Remove the hood. See page 33.

CAUTION

Escaping steam can cause burns. Never remove the pressure cap while the engine is warm or hot. Always allow the engine to cool before removing the pressure cap.

2. If the overflow bottle is dry, slowly remove the radiator pressure cap.
3. View the coolant level through the opening.
4. Use a funnel and slowly add coolant as needed.

MAINTENANCE

5. Reinstall the pressure cap securely. Use of a non-standard pressure cap will not allow the recovery system to function properly. Your POLARIS dealer can provide the correct replacement part.
6. With the pressure cap securely installed, add coolant to the overflow bottle to the recommended level. Reinstall the coolant bottle cap.

POLARIS VARIABLE TRANSMISSION (PVT) SYSTEM

WARNING

Failure to comply with the instructions in this warning can result in severe injury or death.

Do not modify any component of the PVT system. Doing so may reduce its strength so that a failure may occur at a high speed. The PVT system has been precision balanced. Any modification will cause the system to be out of balance, creating vibration and additional loads on components.

The PVT system rotates at high speeds, creating large amounts of force on clutch components. As the owner, you have the following responsibilities for your own safety and the safety of others:

- Always follow all recommended maintenance procedures. Always look for and remove debris inside and around the clutch and vent system when replacing the belt.
- See your POLARIS dealer, or other qualified person, for service and repair assistance.
- This PVT system is intended for use on POLARIS products only. Do not install it in any other product.
- Always make sure the PVT housing is securely in place during operation.

BELT REPLACEMENT / DEBRIS REMOVAL

If a belt fails, always clean any debris from the duct and from the clutch and engine compartments when replacing the belt.

WARNING

Failure to remove ALL debris when replacing the belt could result in vehicle damage, loss of control and severe injury or death.

1. Allow hot components to cool before performing this procedure.
2. Remove the engine access cover and thoroughly clean all debris from the aluminum debris bracket and from the engine compartment.

3. Remove the clutch cover screws and open the clutch cover. (It does not have to be removed from the vehicle.) Remove all debris wrapped in and around the PVT system.

TIP

Use the shock/clutch tool from the tool kit to slightly open the sheaves to aid in debris removal and belt installation.

4. Remove all debris from the entire clutch air duct passage.
5. Check for signs of damage to seals on the transmission and engine. If any seals appear to be damaged, your vehicle requires prompt service. Your POLARIS dealer can assist.

TIP

Belt slip is responsible for creating excessive heat that destroys belts, wears clutch components and causes outer clutch covers to fail. Switch to low range while operating at slower speeds to extend the life of the PVT components (belt, cover, etc.).

PVT DRYING

There may be some instances when water is accidentally ingested into the PVT system. Use the following instructions to dry it out before operating.

1. Remove the clutch cover drain plug.
2. Allow the water to drain. Reinstall the drain plug.
3. Place the transmission in PARK. Apply the brakes.
4. Start the engine.
5. Apply varying throttle for 10-15 seconds to expel the moisture and air-dry the belt and clutches. Do not hold the throttle wide open for more than 10 seconds.
6. Allow the engine RPM to settle to idle speed. Apply the brakes. Shift the transmission to the lowest available range.
7. Test for belt slippage. If the belt slips, repeat the process.
8. Your vehicle requires service as soon as possible. Your POLARIS dealer can assist.

VEHICLE IMMERSION

WARNING

If your vehicle becomes immersed, major engine damage can result if the machine is not thoroughly inspected. Take the vehicle in for service before starting the engine. Your POLARIS dealer can provide this service.

If it's impossible to take your POLARIS vehicle to a dealer before starting it, follow the steps outlined below:

1. Move the vehicle to dry land, or at the very least, to water below the floorboard.
2. Dry any water present in the air box. Filter replacement is required if water is present.
3. Dry any water present in the intake manifold.
4. Remove the spark plugs. Turn the engine over several times using the electric start.
5. Dry the spark plugs and reinstall, or replace with new plugs.
6. Attempt to start the engine. If necessary, repeat the drying procedure.
7. Take the vehicle in for service as soon as possible, whether you succeed in starting it or not. Your POLARIS dealer can provide the required service.
8. If water has been ingested into the PVT follow the PVT Drying procedure.

STEERING WHEEL INSPECTION

Check the steering wheel for specified freeplay and smooth operation at the intervals outlined in the Periodic Maintenance Chart section.

1. Position the vehicle on level ground.
2. Lightly turn the steering wheel left and right.
3. There should be 0.8"-1.0" (20-25 mm) of freeplay.
4. If there is excessive freeplay or strange noises, or the steering feels rough or "catchy," have the steering system inspected by an authorized dealer.

POWER STEERING UNIT

If your model is equipped with power steering, frequently clean the areas around and on the power steering unit to allow proper cooling. Clean these areas ① thoroughly.

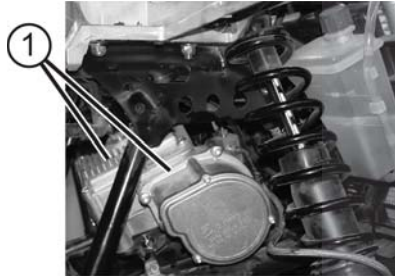

FILTER SYSTEMS

AIR FILTER

Always change the air filter at the intervals outlined in the Periodic Maintenance Chart. Service the air filter more frequently if the vehicle is operated in wet conditions or at high throttle for extended periods.

1. Lift the cargo box to access the air box.
2. Release the air box cover latches and remove the cover.
3. Remove the air filter.
4. Inspect the air box for oil or water deposits. Wipe away any deposits with a clean cloth.
5. Install a new filter if needed. Do not attempt to clean the air filter.

PVT INTAKE SCREEN

The PVT intake screen is located on the driver's side of the vehicle.

Inspect the screen before each use of the vehicle. Remove all dirt and debris from the screen and clean it frequently with warm soapy water.

SPARK ARRESTER

WARNING

Failure to heed the following warnings while servicing the spark arrester could result in serious injury or death.

- Do not perform clean-out immediately after the engine has been run, as the exhaust system becomes very hot. Serious burns could result from contact with the exhaust components. Allow components to cool sufficiently before proceeding.
- Wear eye protection and gloves.
- Never run the engine in an enclosed area. Exhaust contains poisonous carbon monoxide gas that can cause loss of consciousness or death in a very short time.
- Never operate without the spark arrester.

Periodically clean the spark arrester to remove accumulated carbon.

1. Place the transmission in PARK.
2. Remove the arrester retaining bolt and nut.
3. Remove the arrester from the end of the muffler.
4. Use a non-synthetic brush to clean the arrester screen. A synthetic brush may melt if components are warm. If necessary, blow debris from the screen with compressed air.
5. Inspect the screen for wear and damage. Replace a worn or damaged screen.
6. Reinstall the arrester.
7. Torque the bolt to 9-11 ft. lbs. (12-15 Nm).

BRAKES

The front and rear brakes are hydraulic disc type brakes activated by the brake pedal.

WARNING

Do not perform maintenance immediately after the vehicle has been operated, as the brake system may become very hot. Serious burns could result from contact with hot brake components. Allow components to cool before proceeding. Always wear eye protection and gloves.

BRAKE FLUID

Inspect the brake system routinely. Inspect the level of the brake fluid before each operation.

WARNING

After opening a bottle of brake fluid, always discard any unused portion. Never store or use a partial bottle. Brake fluid is hygroscopic, meaning it rapidly absorbs moisture from the air. The moisture causes the boiling temperature of the brake fluid to drop, which can lead to early brake fade and the possibility of accident or severe injury.

Change the brake fluid every two years and any time the fluid becomes contaminated, the fluid level is below the minimum, or if the type and brand of the fluid in the reservoir are unknown.

1. Position the vehicle on a level surface.
2. Place the transmission in PARK.
3. View the brake fluid level at the reservoir in the driver's side wheel well.
4. The level should be between the upper (MAX) and lower (MIN) level lines.
5. If the fluid level is lower than the upper level line, add brake fluid to the upper (MAX) line.
6. Apply the brake forcefully for a few seconds and check for fluid leakage around the fittings.

BRAKE INSPECTION

WARNING

Do not apply WD-40 or any petroleum product to brake discs. These types of products are flammable and may also reduce the friction between the brake pad and caliper.

1. Check the brake system for fluid leaks.
2. Check the brake pedal for excessive travel or a spongy feel.
3. Check the friction pads for wear, damage and looseness.
4. Check brake discs for signs of cracks, excessive corrosion, warping or other damage. Clean any grease using an approved brake cleaner or alcohol.
5. Inspect the brake disc spline and pad wear surface for excessive wear. Change pads when worn to 0.030" (0.762 mm).

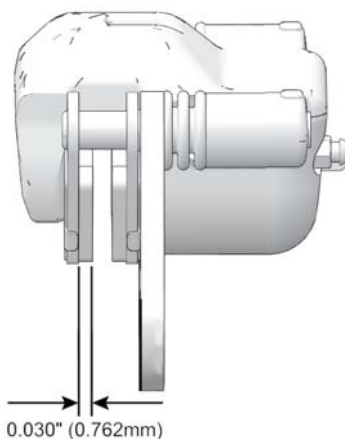

SUSPENSION SETTINGS (EPS)

FRONT/REAR SPRING PRELOAD (EPS)

The front and rear suspensions are preload adjustable, with five possible settings. The suspensions are set on the lowest setting at the factory. The factory setting is appropriate for nearly all riding conditions.

If desired, the suspension may be adjusted to maintain vehicle clearance height when carrying loads. *Always heed the following rules if you make adjustments to this suspension.*

- Always return the suspension to the lowest setting after the load is removed from the vehicle. The increased suspension height will negatively impact vehicle stability when operating without a load.
- Always apply the same adjustment setting to *all four wheels*.

Adjust the front and rear shock springs by rotating the adjustment cam either clockwise or counter-clockwise to increase or decrease spring tension.

SUSPENSION SETTINGS (EPS DELUXE)

FRONT/REAR SPRING PRELOAD (EPS DELUXE)

The front and rear suspensions are preload adjustable. The suspensions are set on the lowest setting at the factory. The factory setting is appropriate for nearly all riding conditions.

If desired, the suspension may be adjusted to maintain vehicle clearance height when carrying loads. *Always heed the following rules if you make adjustments to this suspension.*

- Always return the suspension to the lowest setting after the load is removed from the vehicle. The increased suspension height will negatively impact vehicle stability when operating without a load.
- Always apply the same adjustment setting to *all four wheels*.
- Do not increase the spring preload by more than one inch (25.4 mm) over the factory setting.

FACTORY PRELOAD SETTINGS	
Front	6 5/8" (168.3 mm)
Rear	1 5/8" (41.3 mm)

Your POLARIS dealer can provide the tool required to make suspension adjustments.

1. Elevate the vehicle to allow the suspension to fully extend.
2. Loosen the jam nut and back it away from the adjusting ring.
3. Turn the adjusting ring to the left (1) to increase preload for a stiffer ride. Turn the adjusting ring to the right (2) to decrease preload for a softer ride.

WARNING

Uneven adjustment may cause poor handling of the vehicle, which could result in an accident. Always adjust both the left and right spring preloads equally. Your POLARIS dealer can assist.

4. Tighten the jam nut firmly against the adjuster ring.

FRONT/REAR SHOCK COMPRESSION

The compression damping clicker knob is located at the top of the shock reservoir. When the knob is turned fully clockwise, the damping is in the fully closed position.

1. Turn the clicker clockwise to increase compression damping.
2. Turn the clicker counter-clockwise to decrease compression damping.

MAINTENANCE

SETTING	COMPRESSION DAMPING
Softest	Position 1
Factory	Position 2
Firmer	Position 3

TIRES

WARNING

Operating your vehicle with worn tires will increase the possibility of skidding, loss of control and an accident, which could result in serious injury or death.

Always replace tires when the tread depth measures 1/8" (3 mm) or less.

Improper tire inflation or the use of non-standard size or type of tires may adversely affect vehicle handling, which could result in vehicle damage or personal injury. Always maintain proper tire pressure. Always use POLARIS approved size and type of tires for this vehicle when replacing tires.

TIRE TREAD DEPTH

Always replace tires when tread depth is worn to 1/8" (3 mm) or less.

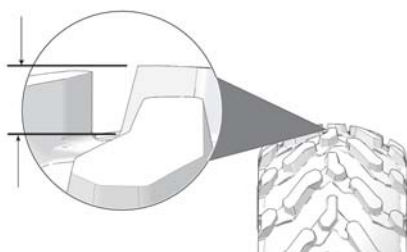

AXLE AND WHEEL NUT TORQUE SPECIFICATIONS

Inspect the following items occasionally for tightness, and if they've been loosened for maintenance service. Do not lubricate the stud or the lug nut.

NUT TYPE	LOCATION	NUT TORQUE
Lug Nut (Aluminum Wheels) 	Front and Rear	120 ft-lbs (163 Nm)
Lug Nut (Tapered)	Front and Rear	60 ft-lbs (81 Nm)

WHEEL REMOVAL

1. Position the vehicle on a level surface.
2. Place the transmission in PARK. Stop the engine.
3. Loosen the wheel nuts slightly.
4. Elevate the side of the vehicle by placing a suitable stand under the frame.
5. Remove the wheel nuts and washers. Remove the wheel.

WHEEL INSTALLATION

1. Place the transmission in PARK.
2. Place the wheel on the hub with the valve stem toward the outside and rotation arrows on the tire pointing toward forward rotation.

WARNING

Improperly installed wheels can adversely affect tire wear and vehicle handling, which can result in serious injury or death. Always ensure that all nuts are torqued to specification. Do not service axle nuts that have a cotter pin installed. Your dealer can assist.

3. Attach the wheel nuts and washers and finger-tighten.
4. Carefully lower the vehicle to the ground.
5. Torque the wheel nuts to specification.

FUSES

If the engine stops or will not start, or if you experience other electrical failures, a fuse may need replacement. Locate and correct any short circuits that may have caused the blown fuse, then replace the fuse. Raise the driver's seat to access the fuses. Spare fuses are provided in the fuse box. The power steering fuse (if equipped) is located on the power steering wiring harness near the fuse box.

If you suspect that a fuse or relay may not be working properly, please see your POLARIS dealer.

LIGHTS

Poor lighting can result in reduced visibility when driving. Headlight and taillight lenses become dirty during normal operation. Clean lights frequently and replace burned out lamps promptly. Do not operate this vehicle at night or in low light conditions until the headlight is replaced. Always make sure lights are adjusted properly for best visibility.

When servicing a halogen lamp, don't touch the lamp with bare fingers. Oil from your skin leaves a residue, causing a hot spot that will shorten the life of the lamp.

MAINTENANCE

HEADLIGHT REPLACEMENT

If a headlight becomes damaged or inoperable, the entire headlight assembly must be replaced. Do not operate this vehicle at night or in low light conditions until the headlight is replaced. Always make sure lights are adjusted properly for best visibility.

HEADLIGHT BEAM ADJUSTMENT

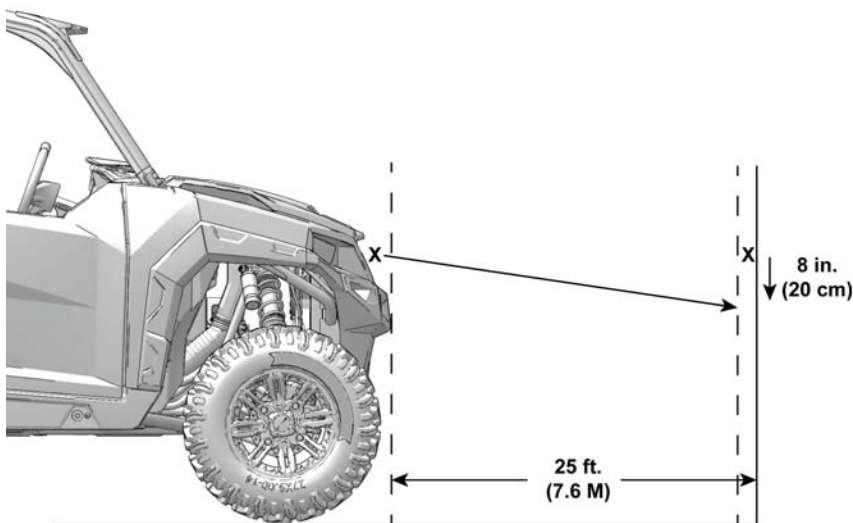

1. Place the vehicle on a level surface with the headlight approximately 25 ft. (7.6 m) from a wall.
2. Place the transmission in PARK.
3. Measure the distance from the floor to the center of the headlight and make a mark on the wall at the same height.
4. Apply the brakes. Start the engine. Turn on the headlights.
5. Observe the headlight aim. The most intense part of the headlight beam should be aimed 8" (20 cm) below the mark placed on the wall. Include the weight of a rider on the seat while performing this step.
6. If a headlight needs adjustment, locate the adjustment screw at the back of the headlight.
7. Loosen the screw. Adjust the headlight, then tighten the screw.
8. Repeat steps 5-7 until the lamp is properly adjusted.

BATTERY

Your vehicle has a sealed battery, which requires little maintenance. Always keep battery terminals and connections free of corrosion. If cleaning is necessary, remove the corrosion with a stiff wire brush. Wash with a solution of one tablespoon baking soda and one cup water. Rinse well with tap water and dry off with clean shop towels. Coat the terminals with dielectric grease or petroleum jelly.

BATTERY REMOVAL

WARNING

Improperly connecting or disconnecting battery cables can result in an explosion and cause serious injury or death. When removing the battery, always disconnect the negative (black) cable first. When reinstalling the battery, always connect the negative (black) cable last.

1. Remove the driver's seat to access the battery.
2. Disconnect the black (-) battery cable first. Disconnect the red (+) battery cable last.
3. Remove the battery hold-down strap.
4. Lift the battery out of the vehicle.

BATTERY INSTALLATION

Using a new battery that has not been fully charged can damage the battery and result in a shorter life. It can also hinder vehicle performance. Follow the battery charging instructions on page 98 before installing the battery.

1. Ensure that the battery is fully charged.
2. Place the fully charged battery in the battery holder. Make sure the positive terminal is toward the driver's side of the vehicle.
3. Coat the terminals with dielectric grease or petroleum jelly.
4. Connect and tighten the red (+) cable first. Connect and tighten the black (-) cable last.
5. Install the hold-down strap.
6. Reinstall the seat.

MAINTENANCE

BATTERY STORAGE

Whenever the vehicle is not used for a period of three months or more, remove the battery from the vehicle, ensure that it's fully charged, and store it out of the sun in a cool, dry place. Check battery voltage each month during storage and recharge as needed to maintain a full charge. See page 98.

TIP

Battery charge can be maintained by using a POLARIS Battery Tender charger or by charging about once a month to make up for normal self discharge.

Battery Tender can be left connected during the storage period, and will automatically charge the battery if the voltage drops below a predetermined point. See page 107 for the part numbers of POLARIS products.

BATTERY CHARGING (SEALED BATTERY)

The following battery charging instructions apply only to the installation of a sealed battery. Read all instructions before proceeding with the installation of this battery.

The sealed battery is already filled with electrolyte and has been sealed and fully charged at the factory. Never pry the sealing strip off or add any other fluid to this battery.

The single most important thing about maintaining a sealed battery is to keep it fully charged. Since the battery is sealed and the sealing strip cannot be removed, you must use a voltmeter or multimeter to measure DC voltage.

WARNING

An overheated battery may explode, causing severe injury or death. Always watch charging times carefully. Stop charging if the battery becomes very warm to the touch. Allow it to cool before resuming charging.

For a refresh charge, follow all instructions carefully.

1. Check the battery voltage with a voltmeter or multimeter. A fully charged battery will register 12.8 V or higher.
2. If the voltage is less than 12.8 volts, recharge the battery at 1.2 amps or less until battery voltage is 12.8 or greater.

TIP

When using an automatic charger, refer to the charger manufacturer's instructions for recharging. When using a constant current charger, use the guidelines on the next page for recharging.

Always verify battery condition before and 1-2 hours after the end of charging.

STATE OF CHARGE	VOLTAGE	ACTION	CHARGE TIME*
*(USING CONSTANT CURRENT CHARGER @ STANDARD AMPS SPECIFIED ON TOP OF BATTERY)			
100%	12.8-13.0 volts	None, check at 3 mos. from date of manufacture	None required
75%-100%	12.5-12.8 volts	May need slight charge, if no charge given, check in 3 months	3-6 hours
50%-75%	12.0-12.5 volts	Needs charge	5-11 hours
25%-50%	11.5-12.0 volts	Needs charge	At least 13 hours, verify state of charge
0%-25%	11.5 volts or less	Needs charge with desulfating charger	At least 20 hours

CLEANING AND STORAGE

WASHING THE VEHICLE

Keeping your POLARIS vehicle clean will not only improve its appearance but it can also extend the life of various components.

NOTICE

Water in the PVT system could cause the drive belt to become wet and slip in the clutches. When washing the vehicle, always avoid spraying water directly toward the PVT intake screen.

High water pressure may damage components. POLARIS recommends washing the vehicle by hand or with a garden hose, using mild soap.

Certain products, including insect repellents and chemicals, will damage plastic surfaces. Do not allow these types of products to contact the vehicle.

The best and safest way to clean your POLARIS vehicle is with a garden hose and a pail of mild soap and water.

1. Use a professional-type washing cloth, cleaning the upper body first and the lower parts last.
2. Rinse with clean water frequently.

MAINTENANCE

3. Dry surfaces with a chamois to prevent water spots.

WASHING TIPS

- Avoid the use of harsh cleaners, which can scratch the finish.
- Do not use a power washer to clean the vehicle.
- Do not use medium to heavy duty compounds on the finish.
- Always use clean cloths and pads for cleaning and polishing. Old or reused cloths and pads may contain dirt particles that will scratch the finish.
- Grease all zerk fittings immediately after washing. Allow the engine to run for a while to evaporate any water that may have entered the engine or exhaust system.

If a high pressure water system is used for cleaning (not recommended), exercise extreme caution. The water may damage components and could remove paint and labels. Avoid directing the water stream at the following items:

- Wheel bearings
- Radiator
- Transmission seals
- Brakes
- Cab and body panels
- Labels and decals
- Electrical components and wiring
- Air intake components

If an informational or graphic label becomes illegible or comes off, contact your POLARIS dealer to purchase a replacement. Replacement safety labels are provided by POLARIS at no charge.

POLISHING THE VEHICLE

POLARIS recommends the use of common household aerosol furniture polish for polishing the finish on your POLARIS vehicle. Follow the instructions on the container.

POLISHING TIPS

- Avoid the use of automotive products, some of which can scratch the finish of your vehicle.
- Always use clean cloths and pads for cleaning and polishing. Old or reused cloths and pads may contain dirt particles that will scratch the finish.

STORAGE TIPS

NOTICE

Starting the engine during the storage period will disturb the protective film created by fogging and damage could occur. Never start the engine during the storage period.

CLEAN THE EXTERIOR

Make any necessary repairs and clean the vehicle as recommended. See page 99.

STABILIZE THE FUEL

1. Fill the fuel tank.
2. Add POLARIS Carbon Clean Fuel Treatment or POLARIS Fuel Stabilizer or equivalent fuel treatments or stabilizers. Follow the instructions on the container for the recommended amount. Carbon Clean removes water from fuel systems, stabilizes fuel and removes carbon deposits from pistons, rings, valves and exhaust systems.
3. Allow the engine to run for 15-20 minutes to allow the stabilizer to disperse through the entire fuel delivery system.

OIL AND FILTER

Change the oil and filter. See page 77.

AIR FILTER / AIR BOX

Replace the air filter. See the Filter Systems section for details. Clean the air box.

INSPECT AND LUBRICATE

Inspect all cables and lubricate all areas of the vehicle as recommended in the Periodic Maintenance Chart section.

BATTERY MAINTENANCE

See page 98 and page 98 for storage and charging procedures.

FLUID LEVELS

Inspect the fluid levels. Add or change fluids as recommended in the Periodic Maintenance Chart section.

- Demand drive fluid (front gearcase)
- Rear gearcase fluid (if equipped)
- Transmission fluid
- Brake fluid (change every two years and any time the fluid looks dark or contaminated)
- Coolant (test strength/fill)

MAINTENANCE

FOG THE ENGINE

1. Treat the fuel system with POLARIS Carbon Clean or other equivalent fuel treatment. Follow the instructions on the container. Start the engine. Allow it to idle for several minutes so the Carbon Clean reaches the injectors. Stop the engine.
2. Remove the spark plugs and add 2-3 tablespoons of engine oil. To access the plug holes, use a section of clear 1/4" hose and a small plastic squeeze bottle filled with the pre-measured amount of oil. *Do this carefully! If you miss the plug holes, oil will drain from the spark plug cavities into the hole at the front of the cylinder head, and appear to be an oil leak.*
3. Reinstall the spark plugs. Torque to specification. See page 83.
4. Apply dielectric grease to the inside of each spark plug cap. *Do not reinstall the cap onto the plug at this step.*
5. Turn the engine over several times. Oil will be forced in and around the piston rings and ring lands, coating the cylinder with a protective film of fresh oil.
6. Reinstall the spark plug caps.
7. If POLARIS fuel system additive is not used, fuel tank, fuel lines, and injectors should be completely drained of gasoline.

STORAGE AREA / COVERS

Be sure the storage area is well ventilated. Cover the vehicle with a genuine POLARIS cover. Do not use plastic or coated materials. They do not allow enough ventilation to prevent condensation, and may promote corrosion and oxidation.

REMOVAL FROM STORAGE

1. Check the battery electrolyte level and charge the battery if necessary. Install it in the vehicle. Make sure the battery vent hose is routed properly and that it's not pinched or restricted in any way.
2. Make sure spark plugs are tight.
3. Fill the fuel tank with fuel.
4. Check all the points listed in the Daily Pre-Ride Inspection section. *Tightness of the bolts, nuts and other fasteners should be checked by an authorized dealer or other qualified service facility.*
5. Lubricate at the intervals outlined in the Periodic Maintenance Chart.

WARNING

Engine exhaust contains poisonous carbon monoxide and can cause loss of consciousness or death. Never run an engine in an enclosed area.

TRANSPORTING THE GENERAL

Follow these procedures when transporting the vehicle.

1. Place the transmission in PARK. Stop the engine.
2. Slowly release the brake pedal and make sure the transmission is in PARK before exiting the vehicle.
3. Remove the key to prevent loss during transporting.
4. Secure the fuel cap, hood, doors (if equipped) and cargo box. Ensure that the seats are attached correctly and are not loose.

WARNING

Cargo and other loose vehicle parts may fly off while transporting this vehicle. Secure or remove all cargo, and inspect the unit for loose parts prior to transport.

5. Always tie the frame of the POLARIS vehicle to the transporting unit securely with suitable straps or rope. Do not attach tie straps to the front A-arm bolt pockets.

SPECIFICATIONS

POLARIS GENERAL 1000

POLARIS GENERAL 1000 EPS / EPS DELUXE	
Maximum Weight Capacity (including operator, passenger, cargo, non-factory installed accessories)	1030 lbs. (467 kg)
Dry Weight	1430 lbs. (649 kg) (EPS) 1491 lbs. (676 kg) (EPS w/Winch and Aluminum Wheels) 1544 lbs. (700 kg) (EPS Deluxe)
Test GVW - Rollover Protection System (ROPS)	2796 lbs. (1268 kg) per OSHA 29 CFR 1928.53
Fuel Capacity	9.5 gal. (36 L)
Engine Oil Capacity	2.5 qts. (2.4 L)
Coolant Capacity	5.44 qts. (5.1 L)
Towing Capacity	2000 lbs. (907 kg)
Hitch Tongue Capacity	150 lbs. (68 kg)
Max. Cargo Box Load*	600 lbs. (272 kg)
Overall Length	116 in. (294.6 cm) (EPS) 118 in. (299.7 cm) (EPS w/Winch and Aluminum Wheels) 118 in. (299.7 cm) (EPS Deluxe)
Overall Width	61.5 in. (156.2 cm)
Overall Height	76 in. (193 cm)
Wheelbase	81 in. (205.7 cm)
Cargo Box Dimensions (Inside)	26 x 43 x 11 in. (66 x 109 x 28 cm)
Ground Clearance	12 in. (30.5 cm)
Min. Turning Radius	190 in. (483 cm)
Engine	4-Stroke DOHC Twin Cylinder
Displacement	999 cc
Bore x Stroke	93 mm x 73.5 mm
Alternator Output	560 W @ 3000 RPM
Compression Ratio	10.5:1
Starting System	Electric

SPECIFICATIONS

POLARIS GENERAL 1000 EPS / EPS DELUXE	
Fuel System	Electronic fuel injection
Ignition System	Electronic
Spark Plug / Gap	MR7F / 0.7-0.8 mm
Front Suspension	Independent Double A-arm w/12.25 in. (31 cm) of travel
Rear Suspension	Independent Double A-arm w/13.25 in. (33.7 cm) of travel
Lubrication System	Wet Sump
Driving System Type	Automatic POLARIS Variable Transmission
Shift Type	Single Lever Dual Range (H/L/N/R/P)
Transmission Gear Ratio - High	10.73:1
Transmission Gear Ratio - Low	22.79:1
Transmission Gear Ratio - Reverse	20.41:1
Front Drive Ratio	3.182:1
Tire Size - Front	27 x 9 - 12 (General Base) 27 x 9 - 14 (General)
Tire Size - Rear	27 x 11 - 12 (General Base) 27 x 11 - 14 (General)
Tire Pressure - Front	10 psi (69 kPa) (General Base) 12 psi (87 kPa) (General)
Tire Pressure - Rear	18 psi (125 kPa) (General Base) 14 psi (96 kPa) (General)
Brakes, Front/Rear	Foot Activated, 4-wheel hydraulic disc
Hood Headlight	2 Dual Beam Halogen
Taillights	10 L.E.D. (.28W)
Brake Light	10 L.E.D. (3.1W)
Instrument Cluster	Analog and LCD
Auxiliary DC Outlet	12V

CLUTCHING (GENERAL)

See your POLARIS dealer or qualified person for clutching specifications.

POLARIS PRODUCTS

LUBRICANTS / SERVICE PRODUCTS

PRODUCT	SIZE (QUANTITY)	PART NUMBER
Fogging Oil	12 oz aerosol (12)	2870791
	1 qt (12)	2871517
PS-4	1 qt (12)	2876244
	2 qt (8)	2877490
	1 gal (4)	2876245
PS-4 Extreme Duty	1 qt (12)	2878920
	2 qt (8)	2878922
	1 gal (4)	2878919
AGL	1 qt (12)	2878068
	1 gal (4)	2878069
Pump for Gallon Jug	3.8 l	2870465
Demand Drive	1 qt (12)	2877922
	2.5 gal (2)	2877923
Antifreeze / Coolant	1 qt (12)	2880514
	1 gal (6)	2880513
Grease Gun Kit, Premium All Season	—	2871312
All Season Grease	Four 3 oz packs (6)	2871322
	14 oz cartridge	2871423
Premium Starter Grease	—	2871460
U-Joint Grease	3 oz tube (24)	2871515
	14 oz cartridge	2871551
Dielectric Grease (Nyogel™)	—	2871329
Carbon Clean	12 oz bottle (12)	2871326
Fuel Stabilizer	16 oz (12)	2870652
	2.5 gal (2)	2872280
DOT 4 Brake Fluid	—	2872189
Loctite™ 565 Thread Sealant	—	2871956
POLARIS Battery Tender™ Charger	—	2859044

TROUBLESHOOTING

DRIVE BELT WEAR/BURN

POSSIBLE CAUSE	SOLUTION
Driving onto a pickup or tall trailer in high range	Use low range during loading.
Starting out going up a steep incline	Use low range. See warnings on page 55.
Driving at low RPM or ground speed (3-7 MPH)	Drive at a higher speed or use low range more frequently.
Insufficient warm-up at low ambient temperatures	Warm the engine at least 5 minutes. With the transmission in neutral, advance the throttle to about 1/8 throttle in short bursts, 5 to 7 times. The belt will become more flexible and prevent belt burning.
Slow/easy clutch engagement	Use the throttle quickly and effectively.
Towing/pushing at low RPM/low ground speed	Use low range only.
Utility use/plowing	Use low range only.
Stuck in mud or snow	Shift the transmission to low range and carefully use fast, aggressive throttle application to engage clutch. WARNING: Excessive throttle may cause loss of control and vehicle rollover.
Climbing over large objects from a stopped position	Shift the transmission to low range and carefully use fast, brief, aggressive throttle application to engage clutch. WARNING: Excessive throttle may cause loss of control and vehicle rollover.
Belt slippage from water or snow ingestion into the PVT system	Dry out the PVT (see page 87). Inspect clutch seals for damage if repeated leaking occurs.
Clutch malfunction	Your POLARIS dealer can assist.
Poor engine performance	Check for fouled plug or foreign material in gas tank or fuel lines. Your POLARIS dealer can assist.
Slippage from failure to warm up belt	Always warm up the belt by operating below 30 mph for one mile (5 miles or more when temperature is below freezing).
Wrong or missing belt	Install the recommended belt.
Improper break-in	Always break in a new belt and/or clutch. See page 46 and page 86.

TROUBLESHOOTING

ENGINE DOESN'T TURN OVER

POSSIBLE CAUSE	SOLUTION
Low battery voltage	Recharge the battery to 12.8 VDC
Loose battery connections	Check all connections and tighten
Loose solenoid connections	Check all connections and tighten
Loose electronic control box connections	Inspect, clean, reinstall connectors

ENGINE TURNS OVER, FAILS TO START

POSSIBLE CAUSE	SOLUTION
Out of fuel	Refuel
Water is present in fuel	Drain the fuel system and refuel
Old or non-recommended fuel	Replace with fresh recommended fuel
Fouled or defective spark plug	Inspect plug and replace if necessary
No spark to spark plug	Inspect plug and replace if necessary
Water or fuel in crankcase	Your authorized dealer can assist
Low battery voltage	Recharge the battery to 12.8 VDC
Mechanical failure	Your authorized dealer can assist

ENGINE BACKFIRES

POSSIBLE CAUSE	SOLUTION
Weak spark from spark plug	Inspect, clean and/or replace spark plug
Incorrect spark plug gap or heat range	Set gap to specs or replace plug
Old or non-recommended fuel	Replace with fresh recommended fuel
Incorrectly installed spark plug wires	Your dealer can assist
Mechanical failure	Your dealer can assist
Loose ignition connections	Check all connections and tighten
Water present in fuel	Replace with fresh recommended fuel

ENGINE PINGS OR KNOCKS

POSSIBLE CAUSE	SOLUTION
Poor quality or low octane fuel	Replace with recommended fuel
Incorrect spark plug gap or heat range	Set gap to specs or replace plug

ENGINE RUNS IRREGULARLY, STALLS OR MISFIRES

POSSIBLE CAUSE	SOLUTION
Fouled or defective spark plug	Inspect, clean and/or replace spark plug
Worn or defective spark plug wires	Your POLARIS dealer can assist
Incorrect spark plug gap or heat range	Set gap to specs or replace plug
Loose ignition connections	Check all connections and tighten
Water present in fuel	Replace with new fuel
Low battery voltage	Recharge battery to 12.8 VDC
Incorrect fuel	Replace with recommended fuel
Clogged air filter	Inspect and clean or replace
Throttle release switch malfunction	Your POLARIS dealer can assist
Other mechanical failure	Your POLARIS dealer can assist

ENGINE STOPS OR LOSES POWER

POSSIBLE CAUSE	SOLUTION
Out of fuel	Refuel
Water is present in fuel	Replace with new fuel
Fouled or defective spark plug	Inspect, clean and/or replace spark plug
Worn or defective spark plug wires	Your POLARIS dealer can assist
Incorrect spark plug gap or heat range	Set gap to specs or replace plug
Loose ignition connections	Check all connections and tighten
Low battery voltage	Recharge the battery to 12.8 VDC

TROUBLESHOOTING

POSSIBLE CAUSE	SOLUTION
Incorrect fuel	Replace with fresh recommended fuel
Clogged air filter	Inspect and clean or replace
Throttle release switch malfunction	Your POLARIS dealer can assist
Other mechanical failure	Your POLARIS dealer can assist
Overheated engine	Clean radiator screen and core, clean engine exterior. Your POLARIS dealer can assist.

WARRANTY

LIMITED WARRANTY

POLARIS Industries Inc., 2100 Highway 55, Medina, MN 55340 (POLARIS) gives a SIX MONTH LIMITED WARRANTY on all components of your POLARIS vehicle against defects in material or workmanship. POLARIS further warrants that the spark arrester in this product will meet the efficiency requirements of USFS standard 5100-1C for at least 1000 hours when subjected to normal use and when maintenance and installation are in accordance with POLARIS recommendations.

This warranty covers parts and labor charges for repair or replacement of defective parts and begins on the date of purchase by the original retail purchaser. This warranty is transferable to another owner during the warranty period through a POLARIS dealer, but any such transfer will not extend the original term of the warranty. The duration of this warranty may vary by international region based upon local laws and regulations.

REGISTRATION

At the time of sale, the Warranty Registration Form must be completed by your dealer and submitted to POLARIS within ten days of purchase. Upon receipt of this registration, POLARIS will record the registration for warranty. No verification of registration will be sent to the purchaser as the copy of the Warranty Registration Form will be your proof of warranty coverage. If you have not signed the original registration and received the customer copy, please contact your dealer immediately. **NO WARRANTY COVERAGE WILL BE ALLOWED UNLESS YOUR VEHICLE IS REGISTERED WITH POLARIS.** Initial dealer preparation and set-up of your vehicle is very important in ensuring trouble-free operation. Purchasing a machine in the crate or without proper dealer set-up will void your warranty coverage.

WARRANTY COVERAGE AND EXCLUSIONS

LIMITATIONS OF WARRANTIES AND REMEDIES

This POLARIS limited warranty excludes any failures that are not caused by a defect in material or workmanship. **THIS WARRANTY DOES NOT COVER CLAIMS OF DEFECTIVE DESIGN.** This warranty also does not cover acts of God, accidental damage, normal wear and tear, abuse or improper handling. This warranty also does not cover any vehicle, component, or part that has been altered structurally, modified, neglected, improperly maintained or used for racing, competition or purposes other than for which it was designed.

This warranty excludes damages or failures resulting from improper lubrication; improper engine timing; improper fuel; surface imperfections caused by external stress, heat, cold or contamination; operator error or abuse; improper component alignment, tension, adjustment or altitude compensation; snow, water, dirt or other foreign substance ingestion/contamination; improper maintenance; modified components; use of aftermarket or unapproved components, accessories, or attachments; unauthorized repairs; or repairs made after the warranty period expires or by an unauthorized repair center.

WARRANTY

This warranty excludes damages or failures caused by abuse, accident, fire, or any other cause other than a defect in materials or workmanship and provides no coverage for consumable components, general wear items, or any parts exposed to friction surfaces, stresses, environmental conditions and/or contamination for which they were not designed or not intended, including but not limited to the following items:

- Wheels and tires
- Suspension components
- Brake components
- Seat components
- Clutches and components
- Steering components
- Batteries
- Light bulbs/Sealed beam lamps
- Filters
- Lubricants
- Bushings
- Finished and unfinished surfaces
- Carburetor/Throttle body components
- Engine components
- Drive belts
- Hydraulic components and fluids
- Circuit breakers/Fuses
- Electronic components
- Spark plugs
- Sealants
- Coolants
- Bearings

LUBRICANTS AND FLUIDS

1. Mixing oil brands or using non-recommended oil may cause engine damage. We recommend the use of POLARIS engine oil.
2. Damage or failure resulting from the use of non-recommended lubricants or fluids is not covered by this warranty.

This warranty provides no coverage for personal loss or expense, including mileage, transportation costs, hotels, meals, shipping or handling fees, product pick-up or delivery, replacement rentals, loss of product use, loss of profits, or loss of vacation or personal time.

THE EXCLUSIVE REMEDY FOR BREACH OF THIS WARRANTY SHALL BE, AT POLARIS' OPTION, REPAIR OR REPLACEMENT OF ANY DEFECTIVE MATERIALS, COMPONENTS, OR PRODUCTS. THE REMEDIES SET FORTH IN THIS WARRANTY ARE THE ONLY REMEDIES AVAILABLE TO ANY PERSON FOR BREACH OF THIS WARRANTY. POLARIS SHALL HAVE NO LIABILITY TO ANY PERSON FOR INCIDENTAL, CONSEQUENTIAL OR SPECIAL DAMAGES OF ANY DESCRIPTION, WHETHER ARISING OUT OF EXPRESS OR IMPLIED WARRANTY OR ANY OTHER CONTRACT, NEGLIGENCE, OR OTHER TORT OR OTHERWISE. THIS EXCLUSION OF CONSEQUENTIAL, INCIDENTAL, AND SPECIAL DAMAGES IS INDEPENDENT FROM AND SHALL SURVIVE ANY FINDING THAT THE EXCLUSIVE REMEDY FAILED OF ITS ESSENTIAL PURPOSE.

THE IMPLIED WARRANTY OF FITNESS FOR A PARTICULAR PURPOSE IS EXCLUDED FROM THIS LIMITED WARRANTY. ALL OTHER IMPLIED WARRANTIES (INCLUDING BUT NOT LIMITED TO THE IMPLIED WARRANTY OF MERCHANTABILITY) ARE LIMITED IN DURATION TO THE

ABOVE SIX MONTH WARRANTY PERIOD. POLARIS DISCLAIMS ALL EXPRESS WARRANTIES NOT STATED IN THIS WARRANTY. SOME STATES DO NOT PERMIT THE EXCLUSION OR LIMITATION OF INCIDENTAL OR CONSEQUENTIAL DAMAGES OR ALLOW LIMITATIONS ON THE DURATION OF IMPLIED WARRANTIES, SO THE ABOVE LIMITATIONS MAY NOT APPLY TO YOU IF INCONSISTENT WITH CONTROLLING STATE LAW.

WARRANTY

HOW TO OBTAIN WARRANTY SERVICE

If your vehicle requires warranty service, you must take it to a POLARIS Servicing Dealer. When requesting warranty service you must present your copy of the Warranty Registration Form to the dealer. (THE COST OF TRANSPORTATION TO AND FROM THE DEALER IS YOUR RESPONSIBILITY.) POLARIS suggests that you use your original selling dealer; however, you may use any POLARIS Servicing Dealer to perform warranty service.

IN THE COUNTRY WHERE YOUR PRODUCT WAS PURCHASED:

Warranty or Service Bulletin repairs must be done by an authorized POLARIS dealer. If you move or are traveling within the country where your product was purchased, Warranty and Service Bulletin repairs may be requested from any authorized POLARIS dealer that sells the same line as your product.

OUTSIDE THE COUNTRY WHERE YOUR PRODUCT WAS PURCHASED:

If you are traveling temporarily outside the country where your product was purchased, you should take your product to an authorized POLARIS dealer. You must show the dealer photo identification from the country of the selling dealer's authorized location as proof of residence. Upon residence verification, the servicing dealer will be authorized to perform the warranty repair.

IF YOU MOVE:

If you move to another country, be sure to contact POLARIS Customer Assistance and the customs department of the destination country before you move. Product importation rules vary considerably from country to country. You may be required to present documentation of your move to POLARIS in order to continue your warranty coverage. You may also be required to obtain documentation from POLARIS in order to register your product in your new country. You should warranty register your product at a local POLARIS dealer in your new country immediately after you move to continue your warranty coverage and to ensure that you receive information and notices regarding your vehicle.

IF YOU PURCHASE FROM A PRIVATE PARTY:

If you purchase a POLARIS product from a private party, to be kept and used outside of the country in which the product was originally purchased, all warranty coverage will be denied. You must nonetheless register your product under your name and address with a local POLARIS dealer in your country to ensure that you receive safety information and notices regarding your product.

EXPORTED PRODUCTS

EXCEPT WHERE SPECIFICALLY REQUIRED BY LAW, THERE IS NO WARRANTY OR SERVICE BULLETIN COVERAGE ON THIS PRODUCT IF IT IS SOLD OUTSIDE THE COUNTRY OF THE SELLING DEALER'S AUTHORIZED LOCATION. This policy does not apply to products that have

received authorization for export from POLARIS. Dealers may not give authorization for export. You should consult an authorized dealer to determine this product's warranty or service coverage if you have any questions. This policy does not apply to products registered to government officials or military personnel on assignment outside the country of the selling dealer's authorized location. This policy does not apply to Safety Bulletins.

NOTICE

If your product is registered outside of the country where it was purchased and you have not followed the procedure set above, your product will no longer be eligible for warranty or service bulletin coverage of any kind, other than safety bulletins. Products registered to government officials or military personnel on assignment outside of the country where the product was purchased will continue to be covered by the Limited Warranty.

Please work with your dealer to resolve any warranty issues. Should your dealer require any additional assistance, they will contact the appropriate person at POLARIS.

This warranty gives you specific legal rights, and you may also have other rights which vary from state to state or in different countries. If any of the above terms are void because of federal, state, local law, all other warranty terms will remain in effect.

For questions call POLARIS Customer Assistance:

United States & Canada: 1-800-POLARIS (1-800-765-2747)

French: 1-800-268-6334

U.S.A. EPA EMISSIONS LIMITED WARRANTY

This emissions limited warranty is in addition to the POLARIS standard limited warranty for your vehicle. POLARIS Industries Inc. warrants that at the time it is first purchased, this emissions-certified vehicle is designed, built and equipped so it conforms with applicable U.S. Environmental Protection Agency emission regulations. POLARIS warrants that the vehicle is free from defects in materials and workmanship that would cause it to fail to meet these regulations.

The warranty period for off road vehicles 100cc or greater emissions-certified vehicles starts on the date of purchase by original retail purchaser and continues for a period of 500 hours of engine operation, 5000 kilometers (3100 miles) of vehicle travel, or 30 calendar months from the date of purchase, whichever comes first. The warranty period for ATVs less than 100cc emissions-certified vehicles starts on the date of purchase by original retail purchaser and continues for a period of 250 hours of engine operation, 2500 kilometers (1550 miles) of vehicle travel, or 30 calendar months from the date of purchase, whichever comes first. This EPA emissions warranty period is extended for at least as long as the standard factory warranty that Polaris provides on the vehicle as a whole. The EPA emissions warranty period does not further extend if you purchase additional warranty coverage in the form of a service contract or other paid warranty extension, but emission-related parts may be covered subject to the terms of any such paid service contract or paid warranty extension.

WARRANTY

This emissions limited warranty covers components whose failure increases the vehicle's regulated emissions, and it covers components of systems whose only purpose is to control emissions. Repairing or replacing other components not covered by this warranty is the responsibility of the vehicle owner. This emissions limited warranty does not cover components whose failure does not increase the vehicle's regulated emissions.

For exhaust emissions, emission-related components include any engine parts related to the following systems:

- Air-induction system
- Fuel system
- Ignition system
- Exhaust gas recirculation systems

The following parts are also considered emission-related components for exhaust emissions:

- Aftertreatment devices
- Crankcase ventilation valves
- Sensors
- Electronic control units

The following parts are considered emission-related components for evaporative emissions:

- Fuel Tank
- Fuel Cap
- Fuel Line
- Fuel Line Fittings
- Clamps*
- Pressure Relief Valves*
- Control Valves*
- Control Solenoids*
- Electronic Controls*
- Vacuum Control Diaphragms*
- Control Cables*
- Control Linkages*
- Purge Valves
- Vapor Hoses
- Liquid/Vapor Separator
- Carbon Canister
- Canister Mounting Brackets
- Carburetor Purge Port Connector

*As related to the evaporative emission control system.

Emission-related components also include any other part whose only purpose is to reduce emissions or whose failure will increase emissions without significantly degrading engine/equipment performance. The exclusive remedy for breach of this limited warranty shall be, at the exclusive option of POLARIS, repair or replacement of any defective materials, components or products. THE REMEDIES SET FORTH IN THIS LIMITED WARRANTY ARE THE ONLY REMEDIES AVAILABLE TO ANY PERSON FOR BREACH OF THIS WARRANTY. POLARIS SHALL HAVE NO LIABILITY TO ANY PERSON FOR INCIDENTAL, CONSEQUENTIAL OR SPECIAL DAMAGES OF ANY DESCRIPTION, WHETHER ARISING OUT OF EXPRESS OR IMPLIED WARRANTY OR ANY OTHER CONTRACT, NEGLIGENCE OR OTHER TORT OR OTHERWISE. THIS EXCLUSION OF CONSEQUENTIAL, INCIDENTAL, AND SPECIAL DAMAGES IS INDEPENDENT FROM AND SHALL SURVIVE ANY FINDING THAT THE EXCLUSIVE REMEDY FAILED OF ITS ESSENTIAL PURPOSE.

ALL IMPLIED WARRANTIES (INCLUDING BUT NOT LIMITED TO ANY IMPLIED WARRANTIES OF MERCHANTABILITY AND FITNESS FOR A PARTICULAR PURPOSE) ARE LIMITED IN DURATION TO THE WARRANTY PERIOD DESCRIBED HEREIN. POLARIS DISCLAIMS ALL EXPRESS WARRANTIES NOT STATED IN THIS WARRANTY. Some states do not allow limitations on how long an implied warranty lasts, so the above limitation may not apply if it is inconsistent with the controlling state law.

This limited warranty excludes failures not caused by a defect in material or workmanship. This limited warranty does not cover damage due to accidents, abuse or improper handling, maintenance or use. This limited warranty also does not cover any engine that has been structurally altered, or when the vehicle has been used in racing competition. This limited warranty also does not cover physical damage, corrosion or defects caused by fire, explosions or other similar causes beyond the control of POLARIS.

WARRANTY

Owners are responsible for performing the scheduled maintenance identified in the owner's manual. POLARIS may deny warranty claims for failures that have been caused by the owner's or operator's improper maintenance or use, by accidents for which POLARIS has no responsibility, or by acts of God.

Any qualified repair shop or person may maintain, replace, or repair the emission control devices or systems on your vehicle. An authorized POLARIS dealer can perform any service that may be necessary for your vehicle. POLARIS also recommends POLARIS parts, however equivalent parts may be used for such service. It is a potential violation of the Clean Air Act if a part supplied by an aftermarket parts manufacturer reduces the effectiveness of the vehicle's emission controls. Tampering with emission controls is prohibited by federal law.

CALIFORNIA RESIDENTS

Certain POLARIS Off-Road Vehicles are available in 49-state and 50-state versions. Only the 50-state models are certified for sale in California. The 50-state models available for sale in California are identified by the letter "B" in the ninth position of the model number (e.g., R16RTE87B). The POLARIS 50-state models are designed and built with features such as a reduced cargo box capacity. Any modifications to these features may be a violation of the applicable California regulations and may void this limited emissions warranty offered by the manufacturer.

If you have any questions regarding your warranty rights and responsibilities, please contact POLARIS Customer Assistance:

United States & Canada: 1-800-POLARIS (1-800-765-2747)

French: 1-800-268-6334

A	D
Adding or Changing Coolant 84	Descending Hills Improperly 23
Age Restrictions 19	Display Units, Standard/Metric 42
Air Filter..... 89	Drive Belt Wear/Burn..... 109
All Wheel Drive/Rear	Drivetrain Break-In..... 45
Differential System 47	Driving Downhill 56
Auxiliary Outlet..... 28	Driving in Reverse 57
Axle and Wheel Nut Torque	Driving on a Sidehill 56
Specifications..... 94	Driving on Slippery Surfaces 55
	Driving Over Obstacles 54
	Driving Procedure..... 53
	Driving Through Water..... 56
	Driving Uphill 55
	Driving with a Passenger..... 54
	Drying the Transmission..... 87
B	E
Battery	Electromagnetic Interference 71
Charging 98	Electronic Power Steering 32
Installation 97	Emissions Limited Warranty..... 117
Overview 97	Engine Backfires 110
Removal..... 97	Engine Break-In 45
Storage 98	Engine Doesn't Turn Over 110
Battery Maintenance 101	Engine Fogging..... 102
Belt Life 52	Engine Oil..... 77
Belt Replacement 86	Engine Oil Change..... 78
Boots 13	Engine Oil Check..... 78
Brake Fluid..... 91	Engine Pings or Knocks 111
Brake Inspection 92	Engine Runs Irregularly, Stalls
Brake Pedal 29	or Misfires 111
Brakes 90	Engine Starting 46
Braking 46	Engine Stopping..... 46
Break-in Period 45	Engine Turns Over, Fails to
	Start..... 110
	Error Codes, Engine..... 43
	European Vibration and Noise 8
	Exhaust Emission Control
	System 71
	Exhaust System Warning 90
	Exported Products 116
	Eye Protection 13
C	
Cab Doors 21	
Cab Frame, ROPS..... 32	
Cargo 50	
Cargo Box, Dumping 52	
Check Engine Indicator 43	
Cleaning and Storage 99	
Clothing..... 13	
Clutching 106	
Component Locations..... 25	
Cooling System..... 84	
Crankcase Emission Control	
System 71	

F

Fan, Cooling	84
Filter Systems	89
Fluid Change	
Engine Oil	78
Front Gearcase	82
Main Gearcase	81
Transmission	81
Fluid Check	
Front Gearcase	82
Main Gearcase	81
Transmission	81
Fluid Level	
Engine Oil	78
Fluid Levels During Storage	101
Fluid Part Numbers	107
Fogging the Engine	102
Fouled Plugs	84
Front Gearcase	82
Fuel Cap	33
Fuel Safety	22
Fuel Stabilizer	101
Fuses	95

G

Gap, Spark Plug	83
Gasoline Handling	22
Gear Selector	26
Gearcase Specification Chart	80
Gearcase, Front	82
Gearcases	81
Gears, Shifting	26
Gloves	13

H

Hauling Cargo	50
Headlight Beam Adjustment	96
Headlight Replacement	96
Helmet	13
Hitch	32
Hitch Weight	51
Hood	33
Hot Exhaust Systems	24

How To Obtain Warranty Service	116
--------------------------------------	-----

I

Ignition Switch	27
Indicator Lamps	37
Instrument Cluster	35
Intake Screen	89

L

Light Switch	28
Lights	95
Limited Warranty	113
Load Capacity	50
Lubricants / Service Products	107
Lubrication Recommendations	77

M

Main Gearcase	81
Maintenance Chart	73
Maintenance Log	121
Maintenance, Periodic	73
Metric Display	42
Mode Button	36
Modifications to Vehicle	19

N

Noise Emission Control System	71
-------------------------------------	----

O

Obstacles	54
Oil and Filter Care During Storage	101
Oil Change	
Engine	78
Front Gearcase	82
Main Gearcase	81
Transmission	81

Oil Level	
Engine	78
Front Gearcase	82
Main Gearcase	81
Transmission	81
Oil Recommendations	77
Operation on Public Lands in the U.S.A.....	71
Operator Safety.....	17

P

Parking on an Incline	58
Parking the Vehicle	57
Part Numbers	107
Periodic Maintenance Chart	73
Plug Gap	83
Plug Torque.....	83
Plugs, Fouled	84
Plugs, Spark.....	83
Polaris Products	107
Polishing the Vehicle	100
Power Steering	32
Power Steering Unit (Cleaning).....	89
Pre-Ride Inspection	47
Programmable Service Interval.....	42
PVT Break-in (Clutches/Belt)	46
PVT Drying	87
PVT Intake Screen.....	89
PVT System	86

R

Radiator and Cooling Fan.....	84
Radiator Coolant Level	85
Receiver Hitch	32
Registration, Warranty	113
Removal from Storage.....	102
Reverse Operation.....	57
Rider Information Center	38
Rollover Protective Structure.....	32
ROPS Cab Frame	32

S

Safe Riding Gear.....	12
Safety Labels.....	14
Safety Symbols.....	7
Safety Training.....	11
Safety, Winch Maintenance.....	68
Seat Belt.....	30
Seat Removal	31
Shifter	26
Shock Compression (EPS Deluxe).....	93
Shock Loading the Winch	67
Signal Words.....	7
Spark Arrester	90
Spark Plug Inspection.....	83
Spark Plug Recommendations	83
Specifications	105
Spring Preload (EPS Deluxe).....	93
Spring Preload (EPS)	92
Stabilize the Fuel.....	101
Stalling While Climbing a Hill.....	23
Steering Wheel Inspection.....	88
Steering Wheel, Adjustment.....	32
Stopping the Engine.....	46
Storage	101
Storage Area	102
Storage Compartment Access.....	31
Storage Compartment, Under- Seat.....	31
Suspension Settings (EPS Deluxe).....	93
Suspension Settings (EPS).....	92
Switches.....	27
Ignition Switch	27
Light Switch.....	28
Mode Button.....	36

T

Tachometer	36
Throttle Pedal	29
Tire Tread Depth	94
Tires	94
Torque, Axle Nuts	94
Torque, Spark Plug	83
Torque, Wheel Nut.....	94

Towing Loads	51
Towing the GENERAL	53
Trailer Hitch Bracket.....	32
Transmission	81
Drying	87
Oil	81
Operation	86
System.....	86
Warning.....	86
Transporting the GENERAL.....	103
Turning Improperly.....	22

U

Unauthorized Use of the Vehicle ...	24
Under-Seat Storage	31

V

Vehicle Identification Numbers	9
Vehicle Immersion	88

W

Warning Symbols	7
Washing the Vehicle.....	99
Water, Immersion of Vehicle.....	88
Wet Fouled Plug.....	84
Wheel Installation	95
Wheel Nut Inspection	94
Wheel Nut Torque.....	94
Wheel Removal.....	95
Winch Cable Care	66
Winch Maintenance and Service Safety	68
Winch Operation	60
Winch Safety Precautions	59
Winch Shock Loading.....	67



*For your nearest Polaris dealer,
call 1-800-POLARIS (765-2747)
or visit www.polaris.com*

*Polaris Industries Inc.
2100 Highway 55
Medina, MN 55340*

*Part No. 9928288 Rev 02
Printed in USA*

