

LOWRANCE

Link-2

Marine Handheld VHF Radio
with GPS

User Guide

ENGLISH



lowrance.com

Copyright © 2013 Navico. All rights reserved.

Lowrance® is a registered trademark of Navico

It is the owner's sole responsibility to install and use this instrument in such a manner that will not cause accidents, personal injury or property damage.

Lowrance disclaims all liability for any use of this product in a way that may cause accidents, damage or that may violate the law.

Governing Language: This statement, any instruction manuals, user guides and other information relating to the product (Documentation) may be translated to, or has been translated from, another language (Translation). In the event of any conflict between any Translation of Documentation, the English language version of the Documentation will be the official version of the Documentation.





This manual represents the Link-2 radio at the time of printing. Lowrance reserves the right to make changes to specifications without notice.

No part of this manual may be copied, reproduced, republished, transmitted or distributed for any purpose, without prior written consent of Lowrance.

Any unauthorized commercial distribution of this manual is strictly prohibited.

Lowrance may find it necessary to change or end policies, regulations, and special offers at any time. We reserve the right to do so without warning. All features and specifications are also subject to change without warning.
All screens in this manual are simulated.

For free owner's manuals and the most current information on this product, its operation and accessories, visit our web site: www.lowrance.com

Important safety information Please read carefully before installation and use.	
	This is the safety alert symbol. It is used to alert you to potentially hazardous situations. Obey all safety messages that follow this symbol to avoid possible injury or death.
	WARNING indicates a potentially hazardous situation which, if not avoided, could result in death or serious injury
	CAUTION indicates a potentially hazardous situation which, if not avoided, could result in minor or moderate injury.
	CAUTION used without the safety alert symbol indicates a potentially hazardous situation which, if not avoided, may result in property damage.

Contents

Safety and operational information.....	7
Important.....	8
Safety Information.....	8
Section 1 - General information.....	9
Section 2 - Controls and keys.....	10
2-1 Keys/Controls and functions.....	11
2-1-1 Use of Softkeys in this radio.....	13
2-1-2 DSC Softkeys.....	14
Section 3 - Operating the radio.....	15
3-1 Power On/Off.....	15
3-2 Adjusting the Squelch level.....	15
3-3 Volume control.....	15
3-4 Channel selection.....	16
3-5 Receiving and transmitting.....	16
3-6 Dual Watch operation.....	17
3-7 3CH operation (Favorite Channel).....	17
3-7-1 Add a favorite channel for the first time.....	17
3-7-2 Modify or delete favorite channel.....	17
3-8 Scan Operation.....	18
3-9 Navigation mode.....	18
3-10 WP select mode.....	19
3-11 Plotter mode.....	19
3-12 GPS satellite mode.....	20
Section 4 - Advanced setup.....	21
4-1 Waypoint.....	22
4-1-1 Add a new waypoint.....	22
4-1-2 Edit a waypoint.....	23
4-1-3 Delete a waypoint.....	24
4-1-4 Set a route to a stored waypoint.....	24
4-2 Backlight adjustment.....	25
4-3 Lamp timer.....	25
4-4 Buddy list (Manage your buddy list).....	26
4-4-1 Add a new buddy name.....	26
4-4-2 Edit a buddy name.....	27

4-4-3 Delete a buddy name.....	27
4-5 Contrast adjustment.....	28
4-6 GPS/DATA	28
4-6-1 Manual (Manually enter your position and UTC time).....	29
4-6-2 Settings: LL display (Show or hide your position).....	29
4-6-3 Settings: Time display (Show or hide the time).....	30
4-6-4 Time offset (Local time).....	30
4-6-5 Settings: Time format (12 or 24 hour clock).....	31
4-6-6 Settings: COG/SOG (Course & speed display options).....	32
4-6-7 GPS alert.....	32
4-6-8 Turn GPS ENABLE on/off.....	33
4-6-9 Set Magnetic Variation (MAG VAR).....	33
4-7 Radio setup	34
4-7-1 Channel Bank selection (UIC).....	34
4-7-2 Channel name editing (CH NAME).....	34
4-7-3 Ring volume adjustment (RING VOLUME).....	35
4-7-4 Beep volume adjustment (KEY BEEP).....	35
4-7-5 Select unit (UNITS).....	35
4-7-6 Set the Priority channel (WATCH MODE).....	36
4-7-7 Weather alerts (WX ALERT).....	36
4-7-8 Set NMEA output (NMEA OUT).....	36
4-7-9 Favorite Channel Setup (FAV CH SETUP).....	37
4-8 DSC setup	38
4-8-1 Enter or check your user MMSI (USER MMSI).....	38
4-8-2 Maintain groups (GROUP SETUP).....	39
4-8-2-1 Enter your groups.....	39
4-8-2-2 Edit groups.....	40
4-8-2-3 Delete a group.....	40
4-8-3 Response to individual calls (INDIV REPLY).....	41
4-8-4 Enable DSC functionality (DSC SELECT).....	41
4-8-5 Response type to LL polling calls (LL REPLY).....	42
4-8-6 Automatic Channel switching (AUTO SWITCH).....	42
4-8-7 DSC Test Reply (TEST REPLY).....	43
4-8-8 Set the inactivity timer (TIMEOUT).....	43
4-9 ATIS SETUP (EU only).....	44
4-9-1 Enter or check your ATIS MMSI (ATIS MMSI).....	44
4-9-2 Enable ATIS functionality (ATIS SELECT).....	45
4-10 Get Buddy	45
4-11 Track log.....	46
4-12 Erase track.....	46
4-13 Reset (Reset to factory defaults)	46

Section 5 - Sending and Receiving DSC Calls	47
5-1 What is DSC?	47
5-1-1 Maritime mobile service identity	47
5-1-2 How can I obtain a MMSI number?	47
5-2 DSC call types	48
5-3 Send an Individual call (INDIVIDUAL)	49
5-3-1 Call to a Buddy	49
5-3-2 Call to others	49
5-4 Reply to the Last Call (LAST CALL)	50
5-5 Send a Group call (GROUP)	50
5-6 Send an All Ships call (ALL SHIPS)	51
5-7 Send using the Call Log (CALL LOG)	51
5-8 Send using the Distress Log (DISTR LOG)	52
5-9 Request the LL position of a buddy (LL REQUEST)	53
5-10 Track your buddy request (TRACK BUDDY)	53
5-10-1 Add or delete a buddy (TRACKLIST)	53
5-10-2 Select your TRACK BUDDY	54
5-10-3 Set the time interval of tracking	54
5-10-4 Start tracking	55
5-11 Make a DSC test call (DSC TEST)	55
5-11-1 Send a DSC TEST call	55
5-11-2 Receiving an incoming DSC TEST call reply (DSC TEST ACK)	56
5-11-3 Acknowledging an incoming DSC TEST call	56
5-12 View User MMSI and GPS information	56
5-13 Receiving DSC Calls	57
5-14 Receiving an All Ships Call (ALL SHIPS)	57
5-15 Receiving an Individual Call (INDIV)	58
5-16 Receiving a Group Call (GROUP)	58
5-17 Receiving a Geographic Area Call (GEOGRAPH)	59
5-18 Receiving a Polled Position Call (POSITION)	59
Section 6 - Distress calls	60
6-1 Send a Distress call	60
6-2 Receiving a Distress Call (DISTRESS!)	62
6-3 Distress Acknowledgement (DISTRESS ACK) or Distress Relay All Ships (DISTRESS REL)	62
6-4 Distress Relay Individual (INDIV DISTR RELAY)	63

Section 7 - Installation Instructions	64
7-1 Batteries and charger	64
7-1-1 Installing the battery pack.....	64
7-1-2 Initial charge	64
7-1-3 GPS connector.....	65
7-1-4 Battery charger operation	66
7-1-5 Mounting battery charger to flat surface	66
7-1-6 Mounting battery charger and bracket onto wall	66
7-2 Installing the belt clip.....	67
7-3 Installing and removing the antenna	68
Appendix A - Technical specifications.....	69
Appendix B - US & ROW VHF Marine Channel Charts.....	71
B-1 International Channel Chart	71
Special Notes on International Channel Usage.....	72
B-2 USA Channel Chart.....	73
Special Notes on USA Channel Usage	74
B-3 CANADA Channel Chart	75
Special Notes on Canada Channel Usage.....	76
B-4 US & Canada WEATHER Channels	77
B-5 EAS (Emergency Alert Systems) Alerts.....	78
Appendix C - EU VHF Marine Channel Charts	80
C-1 EU International Channel Chart.....	80
Special Notes on EU International Channel Usage	81
C-2 Inland Waterways Country Specific table - ATIS ON.....	82
C-3 Special Channels	85
Countries of Intended use in the EU:.....	85

Safety and operational information

FCC Statement

This device complies with part 15 of the FCC Rules. Operation is subject to the following two conditions: (1) This device may not cause harmful interference, and (2) this device must accept any interference received, including interference that may cause undesired operation.

CAUTION: Changes or modifications not expressly approved by the manufacturer could void the user's authority to operate the equipment.

Industry Canada Statement

Under Industry Canada regulations, this radio transmitter may only operate using an antenna of a type and maximum (or lesser) gain approved for the transmitter by Industry Canada. To reduce potential radio interference to other users, the antenna type and its gain should be so chosen that the equivalent isotropically radiated power (e.i.r.p.) is not more than that necessary for successful communication.

Conformément à la réglementation d'Industrie Canada, le présent émetteur radio peut fonctionner avec une antenne d'un type et d'un gain maximal (ou inférieur) approuvé pour l'émetteur par Industrie Canada. Dans le but de réduire les risques de brouillage radioélectrique à l'intention des autres utilisateurs, il faut choisir le type d'antenne et son gain de sorte que la puissance isotrope rayonnée équivalente (p.i.r.e.) ne dépasse pas l'intensité nécessaire à l'établissement d'une communication satisfaisante.

This radio transmitter Link-2 (IC:4697A-LINK2) has been approved by Industry Canada to operate with the antenna types listed below with the maximum permissible gain and required antenna impedance for each antenna type indicated. Antenna types not included in this list, having a gain greater than the maximum gain indicated for that type, are strictly prohibited for use with this device.

Le présent émetteur radio Link-2 (IC:4697A-LINK2) a été approuvé par Industrie Canada pour fonctionner avec les types d'antenne énumérés ci-dessous et ayant un gain admissible maximal et l'impédance requise pour chaque type d'antenne. Les types d'antenne non inclus dans cette liste, ou dont le gain est supérieur au gain maximal indiqué, sont strictement interdits pour l'exploitation de l'émetteur.

Antenna type: Flexible with SMA type connection supplied with the radio.

CE Compliance Statement

This product complies with CE under R&TTE directive 1999/5/EC. The relevant Declaration of Conformity is available in the following website under model documentation section: <http://www.lowrance.com>.

Important

1. DSC functions will not operate until you have entered your user MMSI.
2. The radio channels installed into the radio may vary from country to country, depending upon the model and government or national communications authority regulations.
3. Lowrance recommends that you check the radio operating licensing requirements of your country before using the radio. The operator is solely responsible for observing proper radio installation and usage practices.
4. This radio is designed to generate a digital maritime distress call to facilitate search and rescue. To be effective as a safety device, this radio must be used only within the geographic range of a shore-based VHF marine Channel 70 distress and safety watch system. The geographic range may vary but under normal conditions is approximately 20 nautical miles.

Safety Information

When transmitting, hold the radio in a vertical position with its microphone 2 inches (5 cm) away from your mouth and keep the antenna at least 2 inches (5 cm) away from your head and body.

The radio must be used with a maximum operating duty cycle not exceeding 50%, in typical Push-to-Talk configurations.

DO NOT transmit for more than 50% of total radio use time (50% duty cycle). Transmitting more than 50% of the time can cause FCC RF exposure compliance requirements to be exceeded.

To maintain compliance with the Body Worn configuration use only supplied accessories.

Other body-worn accessories or configurations may not comply with the FCC RF exposure requirements and should be not be used.

The information listed above provides the user with the information needed to make him or her aware of RF exposure, and what to do to assure that this radio operates with the FCC RF exposure limits of this radio.

This Marine VHF radio also complies with the following guidelines and standards regarding RF energy and electromagnetic energy levels as well as evaluation of those levels for human exposure:

- FCC OET Bulletin 65 Edition 97-01 Supplement C, Evaluating Compliance with FCC Guidelines for Human Exposure to Radio Frequency Electromagnetic Fields.
- American National Standards Institute (C95.1-1992), IEEE Standard for Safety Levels with Respect to Human Exposure to Radio Frequency Electromagnetic Fields, 3 kHz to 300 GHz.
- American National Standards Institute (C95.3-1992), IEEE Recommended Practice for the Measurement of Potentially Hazardous Electromagnetic Fields — RF and Microwave.

Section 1 - General information

Congratulations on your purchase of this handheld VHF marine radio Link-2, designed and built using superior technology and craftsmanship. It provides the following useful features:

- Adjustable contrast settings for the LCD
- Adjustable keypad backlighting for easy night time use
- Waterproof and submersible to comply with JIS-7
- GPS latitude and longitude (LL) and time display
- Built-in GPS sensor
- Choice of High or Low (5 W or 1 W) transmission power
- Special CH16 key for quick access to the priority (international distress) channel
- Special 3CH key to select your three favorite channels
- Flexible dual watch facility
- DSC (Digital Selective Calling) capability that meets CLASS-D standards
- DISTRESS call button to automatically transmit the MMSI and position until an acknowledgement is received
- Easy access to a buddy list of up to 20 favorite people
- LL position polling information
- Buddy tracking capacity
- Weather alert facility (US only)
- ATIS facility for inland waterways (Europe only).

CAUTION

Battery caution: This device uses a Lithion Ion battery - please observe the following cautions.

- Do not disassemble
- Do not incinerate or expose to fire
- Dispose of used batteries according to local codes and requirements.

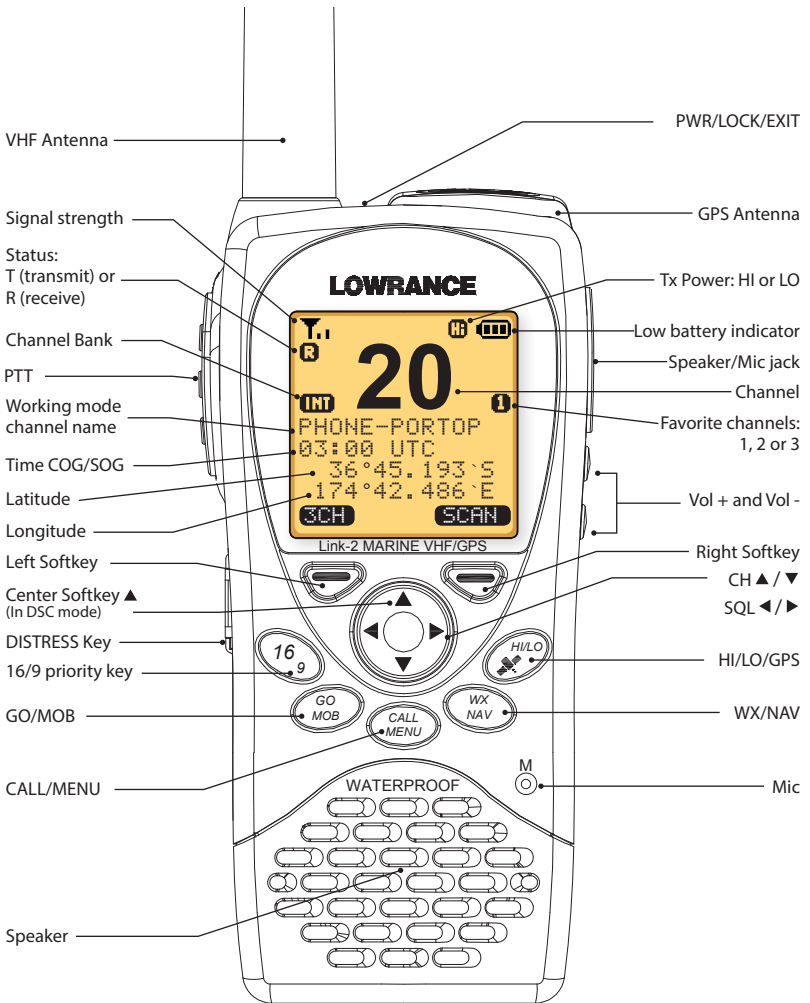

Section 2 - Controls and keys



2-1 Keys/Controls and functions

PWR/LOCK/EXIT

PWR: To turn the unit on and off, press and hold down PWR /  / EXIT (red key) for more than 2 seconds and release.

LOCK: The keylock, locks and unlocks keypad. Press PWR /  / EXIT (red key) for 1 second and release. A key icon  will appear on screen to indicate whether keylock is on or off.

EXIT: Also used to EXIT some menu items while in DSC mode. Short press PWR /  / EXIT (red key) for 1 second and release.

▲ VOL ▼

Volume Adjustment - located on the side of the radio. Press ▲ to increase or press ▼ to decrease until a comfortable volume is reached.

SQL ◀/▶

Squelch or Threshold Level - located on the central control dial. Sets the threshold level for the minimum receiver signal. 16 steps available.

CH ▲/▼

Channel select - located on the central control dial. Press ▲ to select a higher channel or press ▼ to select a lower channel.

16/9

Priority Channel. Press to cancel all other modes (except for when in DSC mode) and to tune into the priority channel. Press again to return to your original channel. To make Channel 09 the default instead, hold down 16/9 until a beep sounds and 09 is displayed (US only).

CH ▲/▼

Channel Select. The current channel is shown on the screen in BIG digits with the channel description information below the channel number.

Press **CH ▲/▼** to step through the available channels one at a time, or hold down to scroll quickly through all the available channels. See Appendix B for a listing of channel charts.

Alphanumeric Entry. This key can also be used for menu selection and alphanumeric entry. Press **CH ▲/▼** to scroll the cursor up or down menu options when navigating menus.



When editing an item that contains only numbers, press - **CH ▲** to count through the numbers or hold down to scroll through quickly.

To enter a character, press **CH ▼** to step through the alphabet or hold down to scroll through quickly.

PTT

Push To Talk. Push to start transmitting then talk into the mic.

HI/LO/

Transmission Power. High (HI) 5 W or Low (LO) 1 W. Press to toggle between high or low transmission powers for the entire channel bank. The  or  selection is shown on the LCD screen.

Some channels allow only low power transmissions. Error beeps will sound if the power transmission setting is incorrect.

Some channels allow only low power transmissions initially, but can be changed to high power by holding down HI/LO and PTT all at the same time. See Appendix B for a complete listing of channel charts.

Hold down  key to enter GPS Satellite mode.

WX/NAV

WX. Quickly press to access Weather channels. Press again to return to your previous mode.

For non US models: The Wx key can be programmed to a weather channel of your choice. See section 4-7-9 to program your favorite channel.

NAV. Hold down WX/NAV for more than 3 seconds to enter Navigation mode. Bearing, Distance and cross track error from the last selected waypoint will display on the screen. If no WP is set, it will appear "NO ACTIVE ROUTE!!" prompt.

GO/MOB

Press GO/MOB if you are navigating to waypoint and want to reset the XTE (cross track error) as shown on the screen.

If someone falls overboard, hold down GO/MOB for about 3 seconds to mark the position.

The latitude and longitude of the Man Overboard position is shown on the screen and is automatically set as the destination waypoint.

CALL/MENU

CALL. Quickly press the CALL/MENU key to access the DSC Call menu. The call mode is used for making DSC calls.

MENU. Hold down the CALL/MENU key more than 3 seconds to access the Menu Setup mode and to customize your VHF radio.

2-1-1 Use of Softkeys in this radio

This radio utilizes 'softkeys' where the functionality of each softkey button will change depending on the mode the radio is in. The bottom line of the LCD display will indicate the function of each softkey located immediately below.

Left softkey (3CH/EXIT)

3CH softkey:

3CH The **3CH** softkey is used to initiate a Three Favorite Channels scan function. Press to toggle between your favorite channels. The **1**, **2**, or **3** symbol appears on the LCD to show which favorite channel is selected.

If you want to scan all three favorite channels, press **3CH**, then immediately press and hold **SCAN**.

To add a favorite channel for the first time, select that channel then hold **3CH** to store it in the CH1 location. Repeat the procedure to store two more favorite channels in the CH2 and CH3 locations respectively.

If you try and add another favorite channel it will overwrite the existing CH3. CH1 and CH2 will remain unless you delete them.

To delete a favorite channel, select that channel then hold down **3CH** until a dialog box appears to prompt the deletion.

EXIT softkey:

EXIT The **EXIT** softkey is used when navigating menus to clear incorrect entries, to exit from a menu without saving changes and to back up to the previous screen.

Right softkey (SCAN/ENTER)

SCAN softkey:

SCAN The **SCAN** softkey is used to initiate a channel scan function. Quick press and release for **Dual Watch** - scan between your current channel and the priority channel in DUAL mode.

Press and hold down **SCAN** for more than 2 seconds to enter **ALL SCAN** mode where the priority channel is checked every 1.5 seconds.

When a signal is received, scanning stops at that channel and "R" appears on the screen. If the signal ceases for more than 5 seconds, the scan restarts.

In ALL SCAN mode, you may wish to 'skip' a channel because it may always be busy and therefore stops the scan. If you wish to 'skip' a channel, hold down the left softkey for more than 2 seconds. **SKIP** will appear on the screen and the channel will be skipped. To cancel the skip, manually select the skipped

channel and press the left softkey for more than 2 seconds.

It is not possible to skip over the priority channel.

ENTER softkey:

ENTER Use the **ENTER** softkey when navigating menus and to confirm entries and edits.

2-1-2 DSC Softkeys

UNABLE

Left softkey. Respond to the call with unable to use the requested channel.

ABLE

Center softkey (▲). Press to ACK (acknowledge) a DSC call.

ACCEPT

Right softkey. Press to ACCEPT a channel request. The radio will immediately change to the requested channel.

NEW CH

Right softkey. Press to request a new channel.

PAUSE

Center softkey (▲). Press to pause a call when in repeat mode.

RESEND

Left softkey. Press to resend the DSC call.

CANCEL

Right softkey. Press to send the distress cancel call.



SILENC

Left softkey. Provided as an option to silence an audible alarm.

Please refer to the following sections for more details.

Section 3 - Operating the radio

3-1 Power On/Off



You can turn on the unit by pressing PWR/  /EXIT switch (on the top side of radio) until the screen and backlight are on. You can also adjust the volume to a comfortable level, by pressing the VOL  /  keys on the side of unit.

Note: Press the PWR/  /EXIT key at any time will turn the display backlight on.

3-2 Adjusting the Squelch level



The SQUELCH control enables you to set the levels of your desired signal. It determines how strong your signal can be before you can hear it, before it “breaks squelch.” It aims to keep any static, unwanted, weak or distant signals from interrupting your conversations.

There are 16 signals to choose from when adjusting the squelch level. To increase the levels, raise the “Squelch Gate” higher so that only stronger signals can get through. Level “0” for instance, means that there is no “Squelch Gate” and everything will get through.

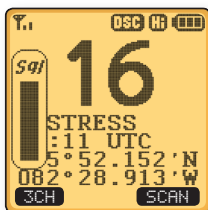
To adjust the squelch level, press SQL  /  accordingly.



3-3 Volume control

Press VOL  /  to adjust the volume level. A volume sub-menu will appear when pressed. It times-out after 5 seconds.

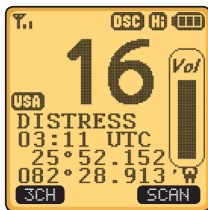

3-4 Channel selection

To manually select a channel, press CH ▲ to increase, or press CH ▼ to decrease the channel number. Communication channels are located on channel 01-28 and 60-88. For more detailed channel chart information, refer to Appendix B.

16/9 (Priority channel)

Press to cancel all other modes (except for when in DSC mode) and to tune into the priority channel. Press again to return to your original channel. The default Priority Channel is CH16.

For US models: To make Channel 09 the priority channel, hold down 16/9 until a beep sounds and 09 is displayed.

3-5 Receiving and transmitting

CAUTION

Transmitting without an antenna may damage the radio.

1. To turn power on, press the PWR key for more than 2 seconds.
2. Adjust for comfortable volume level. (The squelch level temporarily set to "0").
3. Set the suitable Squelch level to mute noise if necessary.
4. Press CH ▲ / ▼ to select the desired channel.
5. When receiving a signal, **R** appears on screen and audio is emitted from the speaker.
6. Further volume adjustment may be needed to get your desired setting.
7. Press HI/LO to select the output power.
8. Choose low power to conserve battery power, or choose high power for longer distance communications.
9. Press and hold "PTT" to transmit, then speak into the microphone, while **T** appears on the screen.
10. Release PTT, to receive conversation.
Note: Some channels are for low power only. Channel 70 cannot be used for transmission.

For clear and audible transmission:

- Pause for a few seconds after pressing PTT
- Hold the microphone 5 to 10 cm (2 to 4 inches) away from your mouth and speak at a normal volume.

3-6 Dual Watch operation

Dual watch monitors channel 16 while receiving another channel. To activate this, you must:

1. Select the desired operating channel (e.g. CH88).
2. Push the SCAN key repeatedly until **DW** appears on screen.
3. To cancel dual watch, press SCAN (once) until **DW** disappears.

If a signal is received on channel 16, dual watch pauses on channel 16 until the signal disappears.

To transmit on the selected channel during dual watch, press and hold PTT.

3-7 3CH operation (Favorite Channel)

You can instantly access the three most frequently used channels by 3CH mode, Three Favorite Channels. Press to toggle between your favorite channels. The **1**, **2**, or **3** symbols appear on the LCD to show which of your favorite channel is selected.

3-7-1 Add a favorite channel for the first time

1. Select the desired channel, then hold 3CH to store it. The CH1 **1** symbol appears on the screen.
2. Repeat the procedure to store two more favorite channels in the CH2 and CH3 locations.

3-7-2 Modify or delete favorite channel

If you try and add another favorite channel it will overwrite the existing CH3. But CH1 and CH2 will remain unless you delete them.

To delete a favorite channel:

- Select that channel, then hold down 3CH until a dialog box appears to prompt the deletion.

3-8 Scan Operation

Scanning is an effective way to locate signals quickly over a wide frequency range.

All Scan

All channels in the set are scanned sequentially, in repeated cycles (CH16 is checked every 1.5 seconds).

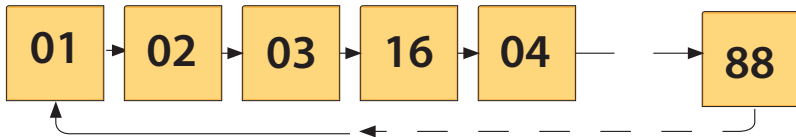

3CH Scan

Press and hold down the SCAN key in the 3CH mode, you will then enter a 3CH SCAN mode. However, only the 3CH and CH16 will be scanned.

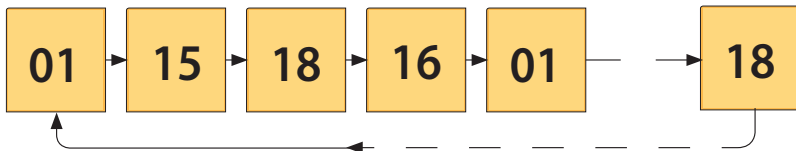

3-9 Navigation mode

Press and hold down NAV key to enter the Navigation Mode. It will display: Bearing, Distance and cross track error from the last selected waypoint.

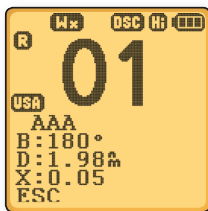

If no WP is set, 'NO ACTIVE ROUTE!!' will appear to prompt you that no WP is selected, see the next section to select a Waypoint to navigate to.

During Nav Mode:

- PTT Return to normal mode and TX; release to return to Navigation mode

- 16/9 Return to normal mode and go to 16/9
- NAV Return to normal mode
- GO Reset the cross track error (XTE)
- SQL ► Go to WP select Mode
- SQL ◀ Go to Plotter Mode
- Other key Error beep.

3-10 WP select mode



- CH ▲ / ▼ Page up down the list
- SQL ◀ Go to Plotter Mode
- SQL ► Returns to Navigation Mode.

Note: During WP Select Mode, press ENTER right-key to flash the first WP, then press CH ▲ / ▼ to select next WP, press ENTER right-key again to set the WP as your next destination and enter navigation mode.

3-11 Plotter mode

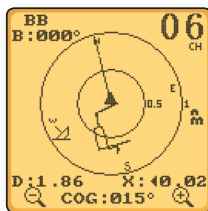

During plotter mode:

- Softkey It will zoom in/out the circle to see more/less area
- SQL ◀ Go to Navigation Mode
- SQL ► Go to WP select Mode

- PTT Return to normal mode and TX
- 16/9 Return to normal mode and go to 16/9
- NAV Go to normal mode
- Other key Error beep.

To avoid screen clutter, a maximum of 5 waypoint icons closest to you plus the active waypoint are shown.

3-12 GPS satellite mode

Press and hold the HI/LO/ ✕ key to enter GPS satellite mode.

During GPS satellite mode:

- PTT Return to normal mode and TX
- 16/9 (16) Return to normal model and go to 16/9
- ✕ Return to normal mode
- Left softkey Return to normal mode
- Other key Error Beep.

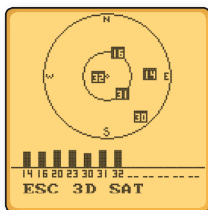

Section 4 - Advanced setup

How to display and navigate menus

1. Hold down CALL/MENU key for more than 1 second to enter the set up menu.
2. Press CH ▲ / ▼ to scroll up and down the menu until the cursor is positioned at the desired items. Press **ENTER** softkey to select the item.
3. Make any changes then press **ENTER** softkey to confirm changes. Otherwise, press **EXIT** softkey to ignore.
4. Press **EXIT** softkey to go back or exit. Any changes are activated as soon as you enter/exit the screen.

How to enter Alphanumeric data

Use the CH ▲ / ▼ key to enter characters.

1. Press ▼ to enter and count through numbers and letters, and hold down to select the desired character.
2. Press ▲ to go through letters of the alphabet, and hold down to select the desired character.
3. Press ENTER to confirm.

The following options are available through MENU:

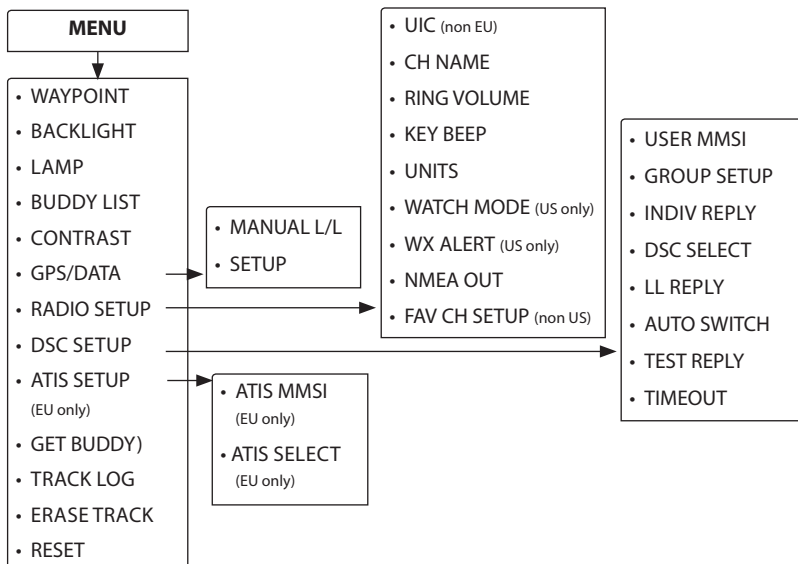

Hold down the CALL/ MENU key for more than 1 second to enter radio set-up mode. This allows the following functions to be accessed. Scroll down the list and press ENTER. To exit the Menu or sub-menu modes press 16 or EXIT.

WAYPOINT	Selects the WP List Entry to enter names and LL positions for a WP. Up to 500 WP can be stored.
BACKLIGHT	Sets the backlight level: 8 levels.
LAMP	Sets the backlight lamp time out.
BUDDY LIST	Selects the Buddy List entry to enter names and MMSI's for regularly called DSC stations. Up to 20 names can be stored.
CONTRAST	Selects display contrast setting: 8 levels.
GPS/DATA	Select to change the GPS/DATA settings: TIME OFFSET, TIME FORMAT, TIME DISPLY, LL DOSPLY, COG/SOG, GPS ALERT, GPS ENABLED, MAG VAR.
RADIO SETUP	Select to change the radio settings: UIC, CH NAME, RING VOLUME, KEY BEEP, UNITS, WATCH MODE, WX ALERT, NMEA OUT, FAV CH SETUP.
DSC SETUP	Select to change the DSC settings: USER MMSI, GROUP SETUP, INDIV REPLY, DSC SELECT, LL REPLY, AUTO SWITCH, TEST REPLY, TIMEOUT.
ATIS SETUP	Select to change the ATIS settings: ATIS MMSI, ATIS SELECT (EU Only).
GET BUDDY	Enable or disable Buddy Data and Auto Function.
TRACK LOG	Set the distance interval for recording the track points.
ERASE TRACK	Erase track history points.
RESET	Reset to factory settings.

4-1 Waypoint

You can store up to 500 waypoints and their LL positions. When your WAYPOINT LIST is full, you cannot make a new entry until you have deleted an existing one.

- Each waypoint name can have a maximum of 6 alphanumeric characters
- The most recent waypoint name will be displayed at the top of your waypoint list.

4-1-1 Add a new waypoint

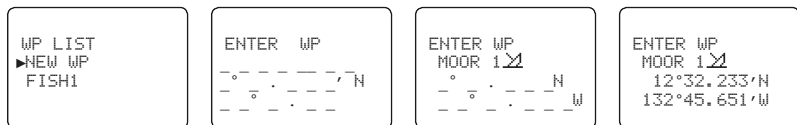

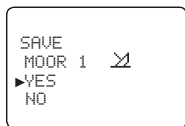

1. Select WAYPOINT and press ENTER.
2. Select WP LIST, and then NEW WP.
3. Use the **CH ▲ / ▼** to enter the new waypoint name, one alphanumeric character at a time. Select one waypoint symbol (there are 20 icons available); and then press ENTER until the cursor moves to the latitude line.
4. Use the **CH ▲ / ▼** to enter the latitude of the waypoint, one number at a time; then press ENTER. The cursor moves to the longitude.
5. Use the **CH ▲ / ▼** to enter the longitude waypoint, one number at a time, then press ENTER.
6. A new screen appears automatically to show the new waypoint details. If they are correct, press ENTER to STORE the new waypoint. (If they are not correct, select EXIT).

4-1-2 Edit a waypoint

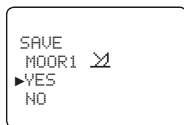
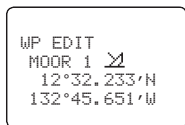
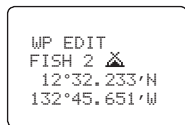
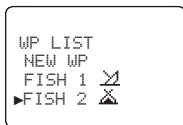
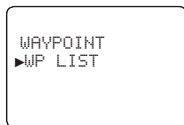

1. Select WAYPOINT and press ENTER.
2. Select WP LIST, then push ENTER, the cursor is at new WP. Scroll down to the waypoint you want to edit then push ENTER.
3. Select WP EDIT and press ENTER.
4. The waypoint details are displayed and the cursor is positioned at the first character of the name.
5. Use the **CH ▲ / ▼** to change the first character of the waypoint name then press ENTER, or just press ENTER to skip to the next character.

When you reach the last character of the waypoint name, make any changes if necessary, then press ENTER to move the cursor to the waypoint icon.

Note: If you do not want to change the waypoint name or waypoint icon, press ENTER repeatedly until the cursor moves to the latitude.

To change the waypoint icon, use the CH ▲ / ▼ to change the icon or press ENTER to skip to latitude. To change latitude, use the CH ▲ / ▼ to change the first digit or press ENTER to skip to the next digit. Repeat if necessary. When you reach the last digit, push ENTER to move the cursor to longitude.

Note: If you do not want to change the latitude, press ENTER repeatedly until the cursor moves to the longitude.

1. Repeat the previous step to change or press ENTER to continue.
2. A new screen appears. Press ENTER if you want to STORE the new waypoint. If you want to keep the original entry, move the cursor to NO then press ENTER.

4-1-3 Delete a waypoint

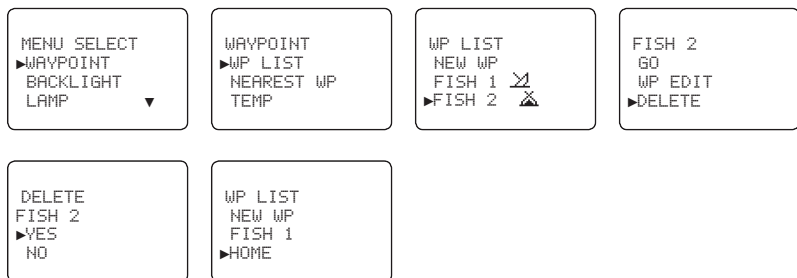

1. Select WAYPOINT and press ENTER.
2. Select WP LIST and press ENTER. The cursor is at NEW WP, scroll down to the waypoint you want to delete, then press ENTER.
3. The cursor is at GO. Move the cursor to delete and push ENTER.
4. The waypoint is deleted immediately and the revised waypoint list is displayed.

4-1-4 Set a route to a stored waypoint



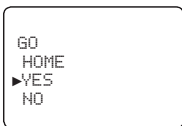

1. Select WAYPOINT and press ENTER.
2. The cursor is at WP LIST, press ENTER. The cursor is at NEW WP, scroll down to the waypoint to use as the route then press ENTER.
3. The cursor is at GO, push ENTER and enter the navigation mode. The waypoint is set as your next destination.

4-2 Backlight adjustment

1. Select BACKLIGHT and press ENTER. There are 8 backlight levels.
2. SQ ◀/▶ to adjust the setting. Press ENTER to confirm the setting and return to the MENU SELECT.



4-3 Lamp timer

1. Select LAMP and press ENTER. There are 4 timer settings: Always on, 5s, 15s, 30s (default).
2. Press CH ▲/▼ to adjust the setting. Press ENTER to confirm the setting and return to the MENU SELECT.

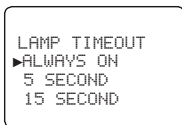

4-4 Buddy list (Manage your buddy list)

You can use the buddy list to store names and associated MMSIs of 20 DSC stations that you call frequently. Buddy names are stored in the order of entry, with the most recent entry first.

The following sections demonstrates how to use BUDDY LIST, these include: to add, edit, and delete entries.

4-4-1 Add a new buddy name

You can enter up to 20 buddy names. When your BUDDY LIST is full, you cannot make a new entry until you have deleted an existing entry.

- Each buddy name can have a maximum of 6 alphanumeric characters
- The most recent buddy name entered is shown at the top of your buddy list.

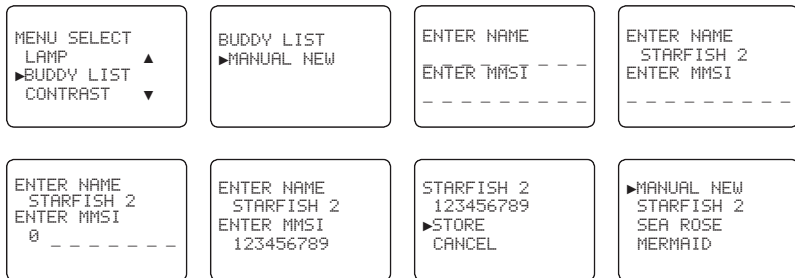

1. Select BUDDY LIST and press ENTER.
2. The cursor is at <MANUAL>. Push ENTER.
3. Use the CH ▲/▼ to enter the new buddy name one character at a time. Then press ENTER until the cursor moves to the MMSI entry line.
4. Use CH ▲/▼ to enter the 9-digit MMSI that is associated with that buddy name, one number at a time, then press ENTER.
5. After you enter the last digit of the MMSI, a new screen appears automatically to show the new buddy name and MMSI. Check that it is correct; and then push ENTER to save the new entry. (If it is not correct, select EXIT).

4-4-2 Edit a buddy name

```
MENU SELECT
LAMP ▲
▶BUDDY LIST
CONTRAST ▼
```

```
BUDDY LIST
MENU SELECT
▶SEA ROSE
MERMAID
```

```
SEA ROSE
EDIT
DELETE
```

```
EDIT NAME
SEA ROSE _ _ _
EDIT MMSI _ _ _
123456789
```

```
EDIT NAME
SEA ROSE
EDIT MMSI
123456789
```

```
EDIT NAME
SEA ROSE
EDIT MMSI
123456798
```

```
SEA ROSE
123456798
▶STORE
CANCEL
```

1. Select BUDDY LIST and press ENTER.
2. Scroll down to the entry you want to edit then press ENTER .
3. The buddy name is displayed and the cursor is positioned at EDIT. Press ENTER.
4. The buddy name and MMSI are displayed. The cursor is at the first character of the name.
5. Use CH ▲ / ▼ to change the first character of the buddy name then press ENTER, or just press ENTER to skip to the next character. Repeat if necessary. When you reach the last character of the buddy name, make any changes if needed, then press ENTER to move the cursor to the MMSI.

Note: If you do not want to change the buddy name, just press ENTER repeatedly until the cursor moves to the MMSI line.

6. To change the MMSI, use CH ▲ / ▼ to change the first number or press ENTER to skip to the next number. Repeat if necessary. When you reach the last number, press ENTER to display the SAVE screen.

Note: If you do not want to change the MMSI, press ENTER repeatedly until the SAVE screen appears.

7. Press ENTER to save the edits or CANCEL to keep the original entry.

4-4-3 Delete a buddy name

```
MENU SELECT
LAMP ▲
▶BUDDY LIST
CONTRAST ▼
```

```
BUDDY LIST
MANUAL NEW
▶SEA ROSE
MERMAID
```

```
SEA ROSE
EDIT
▶DELETE
```

```
DELETE BUDDY
SEA ROSE
▶YES
NO
```

1. Select BUDDY LIST and press ENTER to display the list of buddy names.
2. Scroll down to the buddy name you want to delete then press ENTER.

3. Select DELETE then select YES.
4. The buddy name is deleted and the revised buddy list is displayed.

4-5 Contrast adjustment

1. Select CONTRAST and press ENTER. There are 8 contrast levels. The higher the numbers, the darker LCD screen.
2. SQ ◀/▶ to adjust the setting, Press ENTER to confirm the setting and return to the MENU SELECT.

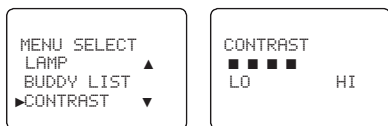

4-6 GPS/DATA

You can use the GPS/DATA menu to:

- manually enter your position data
- manually enter the time data
- show or hide your position
- show or hide the time
- offset the UTC time to show your local time
- format the time display
- show or hide your course (COG) and speed (SOG)
- turn GPS ENABLE ON/OFF
- set True or Magnetic Bearing
- turn NO GPS DATA alarm sound ON/OFF.

Note: This information is important because it will be used if you send a DISTRESS call.

If GPS data is not available, the NO GPS alert will sound for 5 seconds (or until you press any button) and the screen will request you to enter the position data manually.

This will repeat every 4 hours if you do not enter the position data manually. After you have entered the position data, you must update it within 23.5 hours otherwise NO GPS alert sequence repeats.

4-6-1 Manual (Manually enter your position and UTC time)

Use the GPS/DATA menu to manually enter your latitude and longitude and the UTC (time data). The internal GPS must be disabled first in GPS/DATA SETUP. If the internal GPS receives data, all manual entries will be erased.

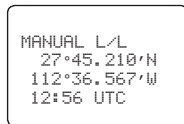
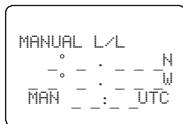
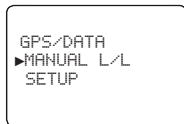
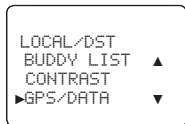

1. Select GPS/DATA and press ENTER.
2. The cursor is at MANUAL, press ENTER. The cursor is then at the first latitude position.
3. Use the **CH ▲ / ▼** to enter the latitude one number at a time. Press ENTER to move cursor to the longitude line.
4. Use the **CH ▲ / ▼** to enter the longitude coordinates one number at a time. Press ENTER to move cursor to the UTC line.
5. Use the **CH ▲ / ▼** to enter the UTC one number at a time then press ENTER.
6. After you enter the last number of the UTC, a new screen appears automatically to show the position and time data. The prefix MAN indicates a manual entry. If you make a mistake, repeat these steps to correct the data.

4-6-2 Settings: LL display (Show or hide your position)

If your position and time data is being updated automatically, you can use LL DISPLAY to choose whether to show or hide your position on the screen.

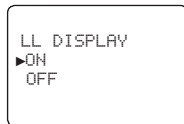
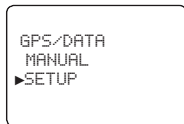
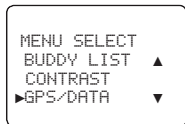

1. Select GPS/DATA, then SETUP.
2. Move the cursor to LL Display and press ENTER.
3. The cursor is at ON (to show your position).

If you want to hide your position, move the cursor to OFF. Press ENTER to confirm your selection.

4-6-3 Settings: Time display (Show or hide the time)

If your position and time data is being updated, you can use TIME DISPLAY to choose whether to show or to hide the time on the screen.



1. Select GPS/DATA, then SETUP.
2. Move the cursor to TIME DISPL and press ENTER.
3. The cursor is at ON (to show the time).
4. If you want to hide the time, move the cursor to OFF.
5. Press ENTER to confirm the selection.

4-6-4 Time offset (Local time)

If your position and time data is being updated, you can use TIME OFFSET to enter the time difference between UTC and local time - so your local time is displayed on the screen.



1. Work out the time difference between UTC and your local time.
2. In the radio setup MENU, select GPS/DATA, then SETUP.
3. The cursor is at TIME OFFSET and press ENTER.
4. Enter + or – followed by the time difference between UTC and your local time. Half hour increments can be used (as in this example). Local time is shown with the suffix LOC.
5. Press ENTER to confirm the selection.

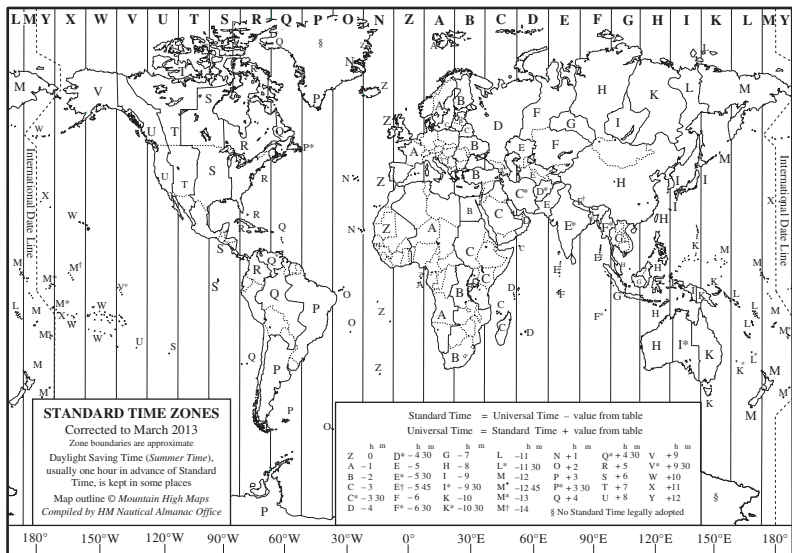

4-6-5 Settings: Time format (12 or 24 hour clock)

Use TIME FORMAT to show the time in 12 or 24 hour format, depending on your preference.

MENU SELECT BUDDY LIST ▲ CONTRAST ►GPS/DATA ▼	GPS/DATA MANUAL ►SETUP	SETUP TIME OFFSET ►TIME FORMAT TIME DISPL▼	TIME FORMAT ►12 HR 24 HR 12:56 PM LOC
--	------------------------------	---	--

1. Select GPS/DATA, then SETUP.
2. Move the cursor to TIME FORMAT and press ENTER.
3. The cursor is at 12 HR (to show the suffix: am or pm). If you want to use the 24 HR clock, move the cursor to 24 HR.
4. Press ENTER to confirm the selection.

4-6-6 Settings: COG/SOG (Course & speed display options)

If your position and time data is being updated, you can use COG/SOG to choose whether to show or hide your course over ground (COG) and speed over ground (SOG) data on the screen.

Note: Despite the COG/SOG setting, if TIME DISPLAY is ON, the course and speed will not display on screen.

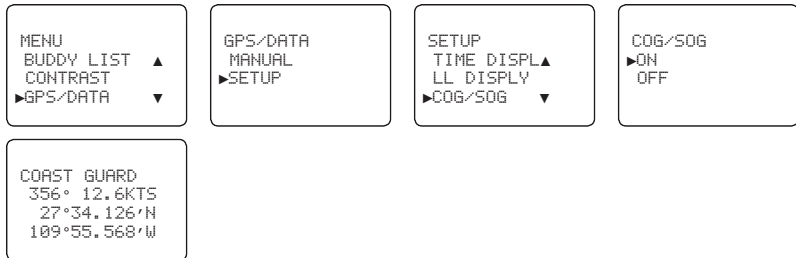

1. Select GPS/DATA, then SETUP.
2. Move the cursor to COG/SOG and push ENTER.
3. Select ON or OFF as desired, In this example, ON has been selected, so the screen shows the bearing and speed.

If COG/SOG is set on, the time will not display on screen.

4-6-7 GPS alert

You can choose to turn the GPS ALERT on/off.



1. Select GPS/DATA, then SETUP.
2. Move the cursor to GPS ALERT and press ENTER.
3. Select ON/OFF as desired, in this example, ON has been selected, so if the GPS signal is lost, then the NO GPS alert will sound.

4-6-8 Turn GPS ENABLE on/off

You can choose to turn the built in GPS function on/off.



1. Select GPS/DATA, then SETUP.
2. Move the cursor to GPS ENABLE and press ENTER.
3. Select ON/OFF as desired, in this example, ON has been selected, so the built in GPS is turned ON.

4-6-9 Set Magnetic Variation (MAG VAR)



1. Select GPS/DATA, then SETUP.
2. Select MAG VAR.
3. Press ENTER to select the first digit to adjust. Use CH ▲ / ▼ to adjust the MAGNETIC difference between true and variation, then press ENTER to confirm selection.
4. Select YES to save your changes.

Note: AUTO MAG VAR default is 00.0 for TRUE.

Note: W is the default and tenths of a degree is required.

4-7 Radio setup

The RADIO SETUP submenu is used to set up functions of the radio.

```
MENU SELECT
CONTRAST ▲
GPS/DATA
▶RADIO SETUP▼
```

4-7-1 Channel Bank selection (UIC)

Non-EU models only

You can select the: USA, International, or Canadian channel band. The channel bands are listed in the appendix sections.

```
RADIO SETUP
▶UIC
CH NAME
RING VOLUM▼
```

```
UIC
▶USA
INT'L
CANADA
```

1. Select RADIO SETUP, the cursor is at UIC, press ENTER.
2. The cursor is at USA. If you want to select the International channel band, move the cursor to INT'L. If you want to select the Canadian channel band, move the cursor to CANADA.
3. Press ENTER to confirm your choice.
4. The new channel band is selected. Depending on your choice, the USA, INT'L, or CAN icon is shown on the screen.

4-7-2 Channel name editing (CH NAME)

To setup the channel name to ON or to blank the first line.

```
RADIO SETUP
UIC
▶CH NAME
RING VOLUM▼
```

```
CH NAME
CALLING
```

```
CALLING
▶EDIT
DELETE
```

1. Select RADIO SETUP, then CH NAME and press ENTER.
2. Select the desired channel name by using the CH ▲ / ▼ . Press ENTER then the screen will show the channel name, EDIT and DELETE (Maximum of 12 characters).
3. Select EDIT and press ENTER to edit the existing name tag. Input the new name over the existing one and press ENTER to display the YES/NO confirmation.

To delete the channel name, just select DELETE then press ENTER.

4. Press ENTER to confirm the new channel name and then press cancel to return to the menu.

4-7-3 Ring volume adjustment (RING VOLUME)

1. Select RADIO SETUP, then RING VOLUME
2. Use CH ▲/▼ to select one of the following options: HIGH or LOW.
3. Press ENTER again to confirm the changes.

```
RADIO SETUP
UIC
CH NAME
▶RING VOLUME▼
```

```
RING VOLUME
▶HIGH
LOW
```

4-7-4 Beep volume adjustment (KEY BEEP)

1. Select RADIO SETUP, then KEY BEEP.
2. Use CH ▲/▼ to select one of the following options: HIGH, LOW, OFF.
3. Press ENTER again to confirm.

```
RADIO SETUP
CH NAME ▲
RING VOLUME
▶KEY BEEP ▼
```

```
KEY BEEP
HIGH
▶LOW
OFF
```

4-7-5 Select unit (UNITS)

You can select your preferred measurement units for distance and cross track error.

1. Select RADIO SETUP, then UNITS.
2. Select your preferred measurement units and press ENTER.

```
RADIO SETUP
RING VOLUME▲
KEY BEEP
▶UNITS ▼
```

```
UNITS
▶METRIC
NAUTICAL
STATUTE
```

4-7-6 Set the Priority channel (WATCH MODE)

US models only

If you are operating on the USA or Canada Channel banks, you can have the priority channel to cover both CH16 and CH09 as well as the working channel, similar to a TRI WATCH.

1. Select RADIO SETUP, then WATCH MODE.
2. Select the desired setting, and then press ENTER.

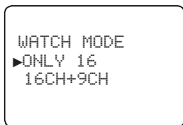
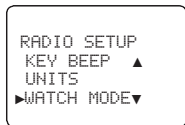

4-7-7 Weather alerts (WX ALERT)

US models only.

The NOAA provides several weather forecast channels on US and Canadian channel banks.

If severe weather such as storms or hurricanes are forecast, the NOAA broadcasts a weather alert on 1050 Hz. You can choose to watch weather alerts.

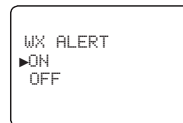
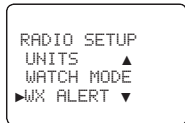

1. Select RADIO SETUP then WX ALERT.
2. The cursor is ON (NOAA weather alerts on 1050 Hz on normal mode). If you do not want to watch these weather alerts, move the cursor to OFF.
3. Press ENTER for to confirm your selection.

If you chose to receive the weather alerts, the beeps will sound whenever a weather alert is broadcast. Just press any button to hear it.

4-7-8 Set NMEA output (NMEA OUT)

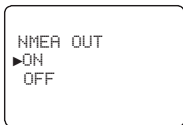
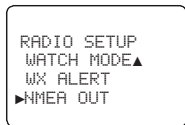

The Link-2 can output NMEA 0183 sentences at 4800 baud when docked in the charging

cradle. Supported sentences are: RMC, GGA, GLL, GSV at 1Hz.

1. Select RADIO SETUP then NMEA OUT.
2. Select ON/OFF then press ENTER to confirm your desired choice.

4-7-9 Favorite Channel Setup (FAV CH SETUP)

EU and AUS models only.

The Wx key can be programmed to a weather channel of your choice so that you have quick access to that channel.

1. Select RADIO SETUP then FAV CH SETU.
2. Press CH UP/DOWN key to select a channel that you want to save as your WX favorite channel. Press ENTER to save the selection. The WX icon  will indicate each time your favorite channel is selected.

4-8 DSC setup

The DSC Setup submenu is used to set behavior of the DSC functions.

4-8-1 Enter or check your user MMSI (USER MMSI)

Note: You must enter your user MMSI before you can access the DSC functions.

When you have entered your MMSI correctly, you can display it any time. Your MMSI will also briefly appear on the startup screen each time the radio is turned on.

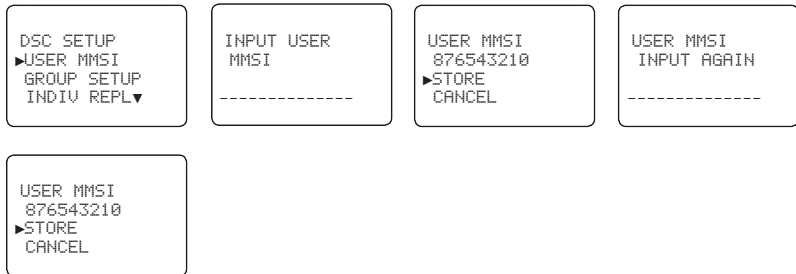

1. Select DSC SETUP then USER MMSI. Press ENTER. If you have already entered your MMSI, it is shown on the screen.

If this is the first time that you are entering your MMSI, a dashed line appears with the cursor under the first position. You need to enter your MMSI along the dashed line, one number at a time.

Note: this is a one-time operation. The MMSI cannot be changed once it is entered in the radio.

2. Press **CH ▲ / ▼** to select the first number of your MMSI. Press ENTER to confirm the number and move to the next position. If you make an error, select the < character then press ENTER to backup.
3. When you have entered the last number, push ENTER to advance to the next screen. The cursor is at STORE.
4. Check whether the displayed MMSI is correct, then press ENTER to store, or EXIT to backup.
5. Enter your MMSI again as a password check, then push ENTER to permanently store the user MMSI and return to the MENU.

Note: You can view your stored user MMSI at anytime by selecting MMSI/GPS under the CALL menu.

4-8-2 Maintain groups (GROUP SETUP)

You can program up to three group MMSI numbers and associated Group names. Group MMSI numbers always begin with a zero (0). You only enter the last 8 digits of the group ID number, the initial "0" is automatically entered.

4-8-2-1 Enter your groups

Use GROUP MMSI to create, edit, or delete up to 20 groups of people that you call frequently. The entries within a group are stored in alphanumeric order. A group MMSI always has nine numbers and always starts with 0.

A group name can have a maximum of 12 alphanumeric characters.



1. Select DSC SETUP then GROUP SETUP.
2. If this is FIRST TIME that you're entering a group name, no group appears. Otherwise, any existing group names. The cursor is at MANUAL NEW.
3. Use CH ▲ / ▼ to enter the new group name, one alphanumeric character at a time.
4. Press ENTER to confirm each correct alphanumeric character and to move to the next position.
5. When you have entered the group name, push ENTER so the cursor moves to the MMSI line.
6. Use CH ▲ / ▼ to enter the MMSI associated with that group name, one number at a time. Pushes ENTER to confirm a number and move to the next position.
7. If you make an error, select the < character then press ENTER.
8. When you have entered the last number of the MMSI, a new screen appears automatically.
9. The cursor is at STORE, check that it is correct and, if so push ENTER to save the new entry. (If it is not correct, select EXIT).

4-8-2-2 Edit groups

You can change a group name or group MMSI at any time.

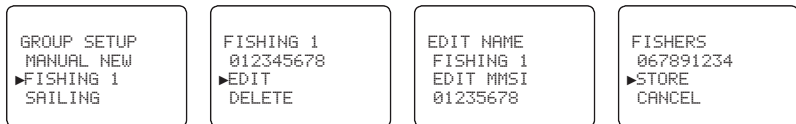

1. Select DSC SETUP then GROUP SETUP.
2. The names of your groups are displayed. Move the cursor to the group you want to edit and push ENTER.
3. The group name and MMSI are displayed, the cursor is at the EDIT, press ENTER.
4. Use the **CH ▲ / ▼** to change the group name. Or, to edit only the MMSI press ENTER repeatedly until the cursor moves to the MMSI line.
5. If you need to change the MMSI associated with that group name, use **CH ▲ / ▼** to change the number then press ENTER.
6. If you do not need to change the MMSI, press ENTER repeatedly to step through the MMSI and then press ENTER.
7. When you are finished, press ENTER to display the next screen.
8. The cursor is at STORE, press ENTER to save the new entry or EXIT to ESC.

4-8-2-3 Delete a group

1. Select GROUP SETUP and press ENTER. The existing group names are displayed on screen.
2. Select what you want to delete and press the **ENTER**. It will display EDIT or DELETE item.
3. Select DELETE and press **ENTER**. It will display DELETE GROUP menu; arrow points to YES, then press thee **ENTER** to empty the group and return to the GROUP SETUP screen. The LCD displays the group as follow.

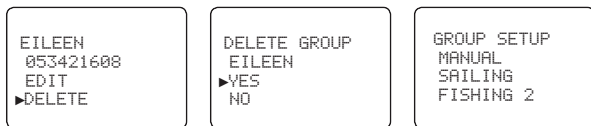

4-8-3 Response to individual calls (INDIV REPLY)

You can respond to an incoming call with either an automatic response or, with a manual response.

- An automatic response sends an acknowledgement and sets-up the channel ready for a conversation.
- A manual response asks if you want to acknowledge the call, and then asks if you want to converse with the caller.

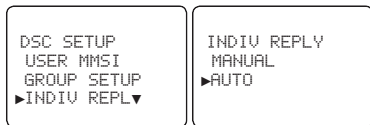

1. Select DSC SETUP, then INDIV REPLY.
2. Select AUTO, for an automatic response, or select MANUAL for a manual response.

4-8-4 Enable DSC functionality (DSC SELECT)

To turn off the DSC function temporarily, such as sailing to inland water or no DSC region.

1. Select DSC SETUP, then DSC SELECT.
2. Select OFF to turn the DSC function off.
3. Press ENTER to confirm your choice and return to the menu.



4-8-5 Response type to LL polling calls (LL REPLY)

You can set up the radio to respond to an LL polling request in one of three ways:

- **MANUAL** reply manually to any incoming LL polling requests from your buddies
- **AUTO** automatically replies to any incoming LL polling requests from any of your buddies
- **OFF** ignores all incoming buddy LL polling requests.

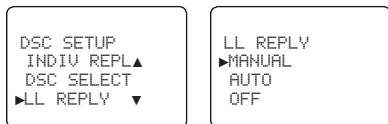

1. Select DSC SETUP then LL REPLY.
2. Select your response and press ENTER to confirm and return to the menu.

4-8-6 Automatic Channel switching (AUTO SWITCH)

When a DSC call is received, it may include a request to change to a specific channel for subsequent communications. If a channel switch request is included, your options are:

- allow the radio to switch to the requested channel immediately by pressing the ENTER button, or
- do nothing to allow the radio to automatically switch to the requested channel after a delay of 10 seconds, or
- cancel the automatic switch and remain on the current channel by pressing the EXIT button.

However, automatic switching to a subsequent communications channel on receipt of a DSC call might in some cases disrupt important ongoing communications if the working channel changes without the operator knowing.

You can prevent the radio from automatically switching from the current working channel by setting the AUTO SWITCH feature to OFF.

If the AUTO SWITCH feature is set to OFF, an **X** will be displayed on the LCD to remind you that this feature is set to off. Additionally, the text "AUTO SW OFF" will be included in an All Ships or Group call replacing the text "AUTO CHxx"

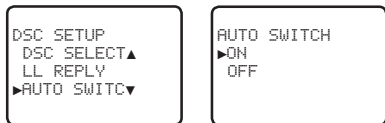

1. Select DSC SETUP, then AUTO SWITCH.
2. Select ON to enable automatic channel switching.
3. Select OFF to disable automatic channel switching.

4-8-7 DSC Test Reply (TEST REPLY)

You can respond to incoming DSC TEST calls with an automatic response or with a manual response.

- **MANUAL** manual response is required, press ENTER to confirm or press EXIT to cancel.
- **AUTO** automatically replies after a 10 second delay with an ACK to any incoming DSC TEST call.

```
DSC SETUP
AUTO SWITC▲
▶TEST REPLY
TIMEOUT
```

```
TEST REPLY
▶AUTO
MANUAL
```

4-8-8 Set the inactivity timer (TIMEOUT)

You can set the inactivity timer with the following options:

```
DSC SETUP
AUTO SWITC▲
TEST REPLY
▶TIMEOUT
```

```
TIMEOUT
AUTOMATED
▶NON AUTO
```

```
NON AUTO
NO TIMEOUT
▶10 MINS
15 MINS
```

- **AUTOMATED** you can set the inactivity timer to automatically timeout after a period of inactivity for the following two categories: NON-DISTRESS or DISTRESS
Timeout options are:
DISTRESS: NO TIMEOUT; 5 MINS; 10 MINS (default is NO TIMEOUT)
NON-DISTR: NO TIMEOUT; 10 MINS; 15 MINS (default is 15 MINS)
- **NON AUTO** you can set the inactivity timer to exit any non-automated procedure activity.
Timeout options are:
NO TIMEOUT; 10 MINS; 15 MINS (default is 10 MINS)

Note: If NO TIMEOUT is selected, then you must press the EXIT key to exit the procedure.

Example: to set a 10 minute TIMEOUT for non-automated functions:

1. Select TIMEOUT, then select NON AUTO
2. Select desired timeout period: NO TIMEOUT, 10 MINS or 15 MINS

In this example, 10 MINS has been selected, meaning the radio will exit any non-automated procedure after a period of 10 minutes of non-activity.

4-9 ATIS SETUP (EU only)

This submenu is used to adjust settings for the ATIS function.

- Press MENU and then select ATIS SETUP, press ENTER to enter the submenu.

You must enter your ATIS MMSI to access ATIS functionality if you are navigating inland waterways within Europe.

ATIS sends a digital message any time that you release the PTT key. An ATIS MMSI always starts with the number 9.

4-9-1 Enter or check your ATIS MMSI (ATIS MMSI)

You must enter your ATIS MMSI before you can access the ATIS functions. This is a **once-only** operation.

You can display and read your ATIS MMSI at any time, but you get only one opportunity to enter your ATIS MMSI.

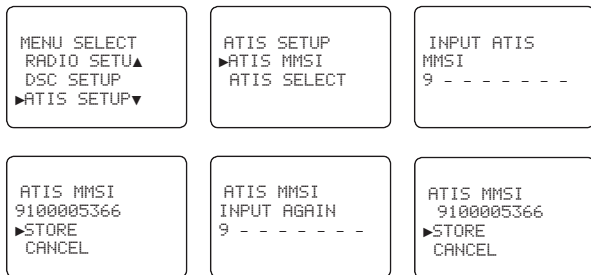

1. Select ATIS SETUP then ATIS MMSI and press the ENTER. If an existing MMSI is stored, the values appear.
2. If the MMSI is blank, a dashed line will appear, except for the initial number '9'. Then enter ATIS MMSI along the dashed line. Press ENTER to confirm each entry and then move to the next line.
3. If you make an error, press CH▼ until < appears, then press the ENTER to backup and correct the entry.
4. When you have entered the last number of the MMSI, a confirmation screen appears. The cursor is at STORE, press ENTER to store your ATIS MMSI.
5. Enter your ATIS MMSI again as a password and check the confirmation screen appears again, select STORE and press ENTER to permanently store your ATIS MMSI and return to the menu.

- You can view your stored ATIS MMSI at anytime by selecting ATIS MMSI in the ATIS SETUP menu.

4-9-2 Enable ATIS functionality (ATIS SELECT)

When ATIS is enabled, the following occurs:

- DUAL watch, Tri Watch and scan functions are disabled
- Inland waterways rules require 1 WTx power on Channels 06, 08, 10, 11, 12, 13, 14, 15, 17, 71, 72, 74, and 77 and 31 if enabled.

To enable/disable ATIS:

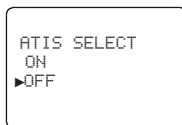
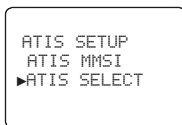

- Select ATIS SETUP, then ATIS SELECT. Press ENTER to display ATIS SELECT ON/OFF.
- Select ON to turn the ATIS function on.
- Press the ENTER to confirm your choice and return to the menu.

4-10 Get Buddy

When the GET BUDDY function is enabled, the radio will transmit your LL data to your Buddies in your BUDDY list each time you release the PTT key. If your buddy also has their GET BUDDY functioned enabled, your details (USER MMSI (or ATIS MMSI) and LL) will appear on their radio such as the distance and bearing to you.

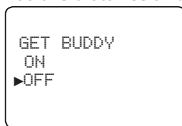
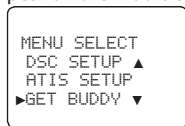

- Select GET BUDDY and then press ENTER. **GB** will appear on the LCD.
- Select ON or OFF as required, then press ENTER to confirm the selection.

4-11 Track log

Set the distance interval to 25 m, 50 m, or 100 m for recording the track points when navigating.

```
MENU SELECT
ATIS SETUP▲
GET BUDDY
▶TRACK LOG ▼
```

```
TRACK LOG
25M
▶50M
100M
```

1. Select TRACK LOG, then press ENTER, the 25 m, 50 m, 100 m appear on the screen.
2. Select your desired and press ENTER to confirm.

4-12 Erase track

Erase the TRACK HISTORY from the plotter screen.

```
MENU SELECT
GET BUDDY ▲
TRACK LOG
▶ERASE TRAC▼
```

```
ERASE TRACK
YES
▶NO
```

1. Select ERASE TRACK, then press ENTER, the radio asks for confirmation.
2. Select Yes, then press ENTER to erase the track line of the plotter screen.

4-13 Reset (Reset to factory defaults)

Use RESET to return every setting on the radio to the factory defaults, except your MMSI, Group MMSIs and ATIS MMSI.

1. Select RESET, press ENTER, the radio asks for confirmation.
2. Select yes, then press ENTER to reset the radio and return to the menu.

```
MENU SELECT
TRACK LOG ▲
ERASE TRACK
▶RESET
```

```
RESET RADIO
ARE YOU SURE
YES
▶NO
```

Section 5 - Sending and Receiving DSC Calls

5-1 What is DSC?

DSC (Digital Selective Calling) is a semi-automated method of establishing VHF, MF, and HF radio calls. It has been designated as an international standard by the IMO (International Maritime Organization) and is part of the GMDSS (Global Maritime Distress and Safety System).

Currently, you are required to monitor Distress Channel 16, but DSC will eventually replace listening watches on distress frequencies and will be used to broadcast routine and urgent maritime safety information.

DSC enables you to send and receive calls from any vessel or coast station that is equipped with DSC functionality and within geographic range. Calls can be categorised as distress, urgency, safety, or routine, and DSC selects a working channel automatically.

5-1-1 Maritime mobile service identity

An MMSI is a nine-digit number used on Marine Transceiver capable of using Digital Selective Calling (DSC). This number is used like a telephone number to selectively call other vessels.

5-1-2 How can I obtain a MMSI number?

You must obtain a user MMSI (Marine Mobile Service Identity) and enter it into your Link-2 in order to use the DSC functions. Contact the appropriate authorities in your country. If you are unsure who to contact, consult your Lowrance dealer.

The user MMSI is a unique nine digit number, similar to a personal telephone number. It is used on marine transceivers that are capable of using DSC (Digital Select Calling).

Depending upon your location, you may need a radio station license for the Link-2. You may also need an individual operator's license.

Lowrance recommends that you check the requirements of your national radio communications authorities before operating DSC functions.



This radio is designed to generate a digital maritime distress and safety call to facilitate search and rescue. To be effective as a safety device, this equipment must be used only within communication range of a shore – based VHF marine channel 70 distress and safety watch system. The range of signal may vary but under normal conditions should be approximately 10 nautical miles.

Quickly press the CALL/MENU key to display the DSC CALL menu. You can then select the DSC call type to send. The channel remains unchanged and allows normal Tx operation.

5-2 DSC call types

Quick press the CALL/MENU key to select DSC call type to send.

Note: Only 3 call types can be shown at any one time on the screen.

Press CH ▲ / ▼ to scroll up and down the call types until the cursor is positioned at the desired option. Press ENTER.

The call types are:

Call Type	Description
INDIVIDUAL	Make a new call, by inputting the MMSI or pick up from the list max 20.
LAST CALL	Recalls last call no matter what type of call it is.
GROUP	Sends transmissions that are only received by radios that share a common group MMSI number, up to 20 group MMSI numbers can be stored and called.
ALL SHIPS	Makes an Urgency or Safety call to all ships. A confirmation screen follows the priority selection of these options. The Safety call is for advisory alert only.
CALL LOG	Allows a review of all stored calls by number and time of call. An individual call type can be placed to the selected MMSI/NAME in the LOG. The LOG contains all received call types except DISTRESS calls. The call at the end of the list is automatically erased. The earliest call is stored at the end of the list. Note: Only 20 calls can be stored at one time.
DISTRESS LOG	Allows a review of all stored Distress calls by number and time of call. An individual call type can be placed to the selected MMSI/NAME in the LOG. The call at the end of the list is automatically erased. This means the earliest call is stored at the end of the list. Up to 20 DISTRESS calls can be stored.
SEND CALL	The Send Call log contains the contact details for the 20 most recent sent calls so that you review details of the call.
LL REQUEST	Enables you to request GPS position information from any vessel that has a known MMSI number. The request can be picked up through the buddy list or manual entry.
TRACK BUDDY	Track the GPS position information from up to three vessels that have a known MMSI number.
DSC TEST	You can test your radio's DSC operation by sending a DSC TEST CALL to a Buddy or other station equipped with a DSC radio.
MMSI/GPS	The radio's MMSI can be viewed as well as the current position.

5-3 Send an Individual call (INDIVIDUAL)

You can call anyone who has a DSC equipped radio providing you know their MMSI.

5-3-1 Call to a Buddy

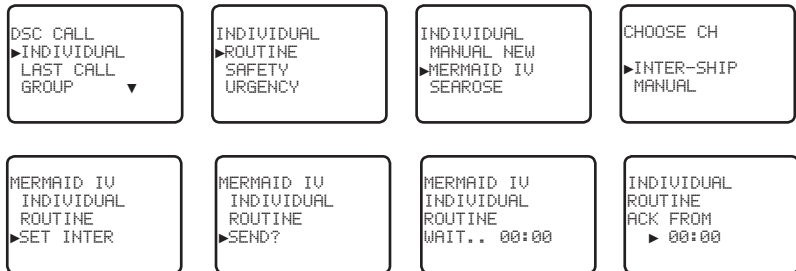

5-3-2 Call to others

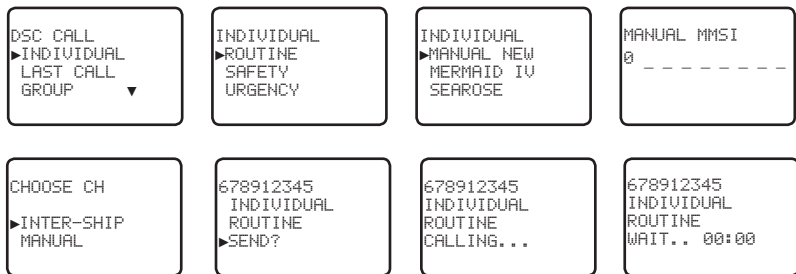

1. Select DSC CALL then INDIVIDUAL.
2. Select the priority level: ROUTINE, SAFETY, URGENCY.
3. Select the buddy you want to call from your buddy list - *or* Select MANUAL NEW then enter the MMSI of the individual you want to call and press ENTER.
4. Choose a working channel to talk on. Select the INTER-SHIP and press ENTER. The radio automatically lists all Inter-ship (Simplex) channels that can be used. Duplex channels cannot usually be called, however, if you wish to use a Duplex channel, select MANUAL instead, then select your channel of choice. If the call is to a Coast Station (MMSI begins with 00) the radio will recognize this and specify the correct channel to talk on.
5. Press ENTER to SEND the call. Channel 70 is selected automatically and the Tx symbol is shown on the LCD while the call is being sent.
6. The radio waits for an acknowledgement (WAIT). If the call is acknowledged (INDIV

ACK) press PTT to talk. Rotate the Channel Select knob to view additional options.

- If there is no reply (UNABLE TO ACKNOWLEDGE) a message asks if you want to retry (SEND AGAIN?). Press ENTER to retry the call.

5-4 Reply to the Last Call (LAST CALL)

This facility is useful and used frequently.



- Select DSC CALL then LAST CALL.
- The contact details of the most recent incoming call are displayed. Press ENTER.
- Choose a working channel to talk on. Select the INTER-SHIP and press ENTER. The radio automatically lists all Inter-ship (Simplex) channels that can be used. Duplex channels cannot usually be called, however, if you wish to use a Duplex channel, select MANUAL instead, then select your channel of choice. If the call is to a Coast Station (MMSI begins with 00) the radio will recognize this and specify the correct channel to talk on.
- The call details are shown. Press ENTER to send the call. The Tx symbol is displayed on the LCD while the call is being sent.
- If the call is acknowledged (INDIV ACK) press PTT to talk. If there is no reply a message asks if you want to retry (SEND AGAIN?). Press ENTER to retry the call.

5-5 Send a Group call (GROUP)

You must already have stored a GROUP MMSI before making the call - see section 4-8-2. Group calls are always sent with ROUTINE priority.



- Select DSC CALL then GROUP.

The radio displays the names of your pre-programmed groups.
- Select the group that you want to call (the GROUP MMSI must be set before making the call).
- Choose a working channel to talk on. Select the INTER-SHIP and press ENTER. The radio automatically lists all Inter-ship (Simplex) channels that can be used. Duplex

channels cannot usually be called, however, if you wish to use a Duplex channel, select MANUAL instead, then select your channel of choice.

- The call details are shown. Press ENTER to send the call. The Tx symbol is displayed on the LCD while the call is being sent.

5-6 Send an All Ships call (ALL SHIPS)

```
DSC CALL
LAST CALL ▲
GROUP
▶ALL SHIPS ▼
```

```
ALL SHIPS
▶SAFETY
URGENCY
```

```
CHOOSE CH
▶INTER-SHIP
MANUAL
```

```
ALL SHIPS
SAFETY
▶SEND?
```

- Select DSC CALL then ALL SHIPS.
- Select one of the following call priorities:
 - SAFETY** To send safety information to all other vessels in range.
 - URGENCY** For use when a serious situation or problem arises that could lead to a distress situation.
- Choose a working channel to talk on. Select the INTER-SHIP and press ENTER. The radio automatically lists all Inter-ship (Simplex) channels that can be used. Duplex channels cannot usually be called, however, if you wish to use a Duplex channel, select MANUAL instead, then select your channel of choice.
- The call details are shown. Press ENTER to send the call. The Tx symbol is displayed on the LCD while the call is being sent.

5-7 Send using the Call Log (CALL LOG)

The Call Log contains the contact details for the 20 most recent incoming calls, so that you can call any of them again quickly.

```
DSC CALL
GROUP ▲
ALL SHIPS
▶CALL LOG ▼
```

```
11 12345678
INDIVIDUAL
ROUTINE
09:45 UTC
```

```
11 12345678
▶CALL BACK
DELETE
SAVE MMSI
```

```
CHOOSE CH
▶INTER-SHIP
MANUAL
```

```
12345678
INDIVIDUAL
ROUTINE
▶SEND?
```

- Select DSC CALL then CALL LOG.
- The radio displays the contact details for the most recent incoming call as the first

entry (01) in the call log. In the example, the contact details for the 11th most recent call are displayed. Press ENTER to move to the next screen.

3. Press ENTER again to confirm the call back.
4. Choose a working channel to talk on. Select the INTER-SHIP and press ENTER. The radio automatically lists all Inter-ship (Simplex) channels that can be used. Duplex channels cannot usually be called, however, if you wish to use a Duplex channel, select MANUAL instead, then select your channel of choice. If the call is to a Coast Station (MMSI begins with 00) the radio will recognize this and specify the correct channel to talk on.

The call details are shown. Press ENTER to send the call. The Tx symbol is displayed on the LCD while the call is being sent.

5-8 Send using the Distress Log (DISTRS LOG)

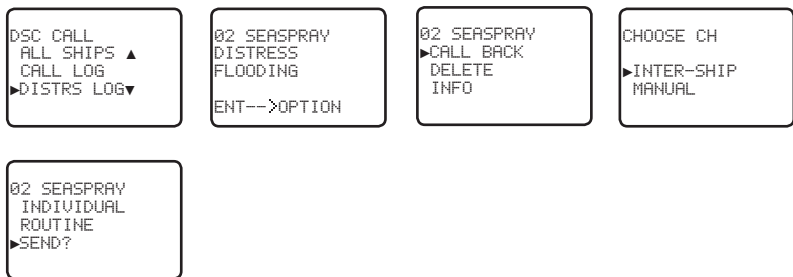

The Distress Log contains the Distress Log data for the 20 most recent received Distress Calls, so that you can call any of them quickly. Always try to make voice contact on CH16 first, as follows:

1. Select DSC CALL then DISTRS LOG.
2. The most recently received Distress Call is the first entry (01) in the Distress Log. Select the entry that you want to call and press ENTER.
3. Select one of the following options:
 - **CALL BACK** To CALL the station.
 - **DELETE** To delete the details from the distress log.
 - **INFO** To view additional information about the station.
4. Select CALL BACK and press ENTER.
5. Choose a working channel to talk on. Select the INTER-SHIP and press ENTER. The radio automatically lists all Inter-ship (Simplex) channels that can be used. Duplex channels cannot usually be called, however, if you wish to use a Duplex channel, select MANUAL instead, then select your channel of choice. If the call is to a Coast

Station (MMSI begins with 00) the radio will recognize this and specify the correct channel to talk on.

- The call details are shown. Press ENTER to send the call. The Tx symbol is displayed on the LCD while the call is being sent.

5-9 Request the LL position of a buddy (LL REQUEST)

```
DSC CALL
DISTRS LOG▲
SENT CALL
▶LL REQUEST▼
```

```
LL REQUEST
▶STARFISH
  SEAROSE
  MERMAID IV
```

```
STARFISH
LL REQUEST
▶SEND?
```

```
STARFISH
LL REQUEST
CALLING...
```

```
STARFISH
LL REQUEST

WAIT.. 00:00
```

- Press CALL to enter DSC mode, then select LL REQUEST.
- Select the buddy whose LL position you want to request then press ENTER to send the request.
- The radio waits for an acknowledgement from your buddy. If there is no reply after 30 seconds the radio asks if you want to retry. Press ENTER to retry the call.
- If the call is acknowledged, press **SILENC** softkey to silence the alert, press ◀/▶ keys to scroll any further information about the call.

5-10 Track your buddy request (TRACK BUDDY)

Use the TRACK LIST option to select a buddy (or buddies) whose position you want to track. Specify the time interval through the INTERVAL option, to start the track alternatively. If the buddy name and time interval are already set to your preference, just start tracking.

5-10-1 Add or delete a buddy (TRACKLIST)

```
DSC CALL
SENT CALL ▲
LL REQUEST
▶TRACK BUDD▼
```

```
TRACK BUDDY
START TRACK
SET BUDDY
▶TRACKLIST ▼
```

```
TRACKLIST
▶ADD NEW
  SAM
```

```
ADD NEW
▶KATHY
  SEA ROSE
```

```
TRACKLIST
▶ADD NEW
  KATHY
  SAM
```

1. Press CALL/MENU to enter DSC MENU, then select TRACK BUDDY.
2. Select TRACKLIST. Any buddies that are already on the track list will be listed.
3. **Note:** To delete a buddy from the track list, select the buddy that you want to delete, then press ENTER. Select Yes and press ENTER to confirm your choice.
4. Select ADD NEW to show your buddy list.
5. Select the target buddy then press ENTER to add that buddy to the track list.

5-10-2 Select your TRACK BUDDY

Select your buddy as follows:

```
DSC CALL
SENT CALL ▲
LL REQUEST
▶TRACK BUDD▼
```

```
TRACK BUDDY
START TRACK
▶SET BUDDY
  TRACKLIST ▼
```

```
SET BUDDY
▶KATHY OFF
  SAM ON
  BUDDY #3 OFF
```

```
SET BUDDY
  KATHY
  ▶ON
  OFF
```

1. Press CALL/MENU to enter DSC MODE, then select TRACK BUDDY.
2. Select SET BUDDY and scroll down to your desired buddy. You can set a maximum of three buddies to track.
3. Select ON to track that buddy, or OFF to not. Press ENTER to confirm. (Repeat for the other two buddies if necessary.)

5-10-3 Set the time interval of tracking

Set the time interval as follows:

```
DSC CALL
SENT CALL ▲
LL REQUEST
▶TRACK BUDD▼
```

```
TRACK BUDDY
SET BUDDY ▲
  TRACK LIST
  ▶INTERVAL
```

```
INTERVAL
▶15 MINUTES
  30 MINUTES
  1 HOUR
```

1. Press CALL/MENU to enter DSC mode, then select TRACK BUDDY.
2. Select INTERVAL, and choose the desired time interval. Press ENTER to confirm.

5-10-4 Start tracking

Start tracking as follows:

```
DSC CALL
SENT CALL ▲
LL REQUEST
▶TRACK BUDD▼
```

```
TRACK BUDDY
▶START TRACK
SET BUDDY
TRACKLIST ▼
```

```
SET TRACK
KATHY 1 OFF
SAM 2 ON
BUDDY #3 3 OFF
```

```
START TRACK
▶YES
NO
```

1. Press CALL/MENU to enter DSC mode, then select TRACK BUDDY.
2. Select START TRACK, then YES. The START TRACK display changes to STOP TRACK. To stop tracking at any time, just press YES.
3. As soon as you start tracking, an LL Request is sent immediately on CH70 and your radio; and it waits for acknowledgement of the (first) buddy's LL position to be displayed on your radio screen.

Each of the selected buddies is polled for their LL positions at regular time intervals.

When information is received, a friendly ring tone sounds and the position is shown on the screen. Pressing any key cancels the screen.

The position that is received is not stored in your radio's Log, but is broadcast over NMEA 0183 to the chartplotters. Press any key to acknowledge, or wait for the automatic 20 second timeout.

Note: The Link-2 is capable of receiving and displaying the LL position data at normal or enhanced resolution.

5-11 Make a DSC test call (DSC TEST)

You can test your radio's DSC operation by sending a DSC TEST CALL to a Buddy or other station equipped with a DSC radio.

Note: You should not use a routine DSC call to test your radio and you should minimize the use of the safety channel for test purposes.

5-11-1 Send a DSC TEST call

1. Select DSC CALL then DSC TEST.
2. Select the buddy you want to call from your buddy list, or Select MANUAL NEW then enter the MMSI of the individual you want to call.
3. Press ENTER to accept the selection.
4. Press ENTER again to SEND the call. Channel 70 is selected automatically and the **TX** symbol is shown on the LCD while the call is being sent.
5. The radio waits for an acknowledgement (WAIT). If the call is acknowledged a notification is displayed.

```
DSC CALL
LL REQUEST▲
TRACK BUDDY
▶DSC TEST ▼
```

```
DSC TEST
MANUAL NEW
SAM
▶TOM
```

```
TOM
DSC TEST
▶SEND?
```

```
TOM
DSC TEST
WAIT.. 00:17
```

6. If there is no reply after 30 seconds, the radio asks you if you want to retry.

5-11-2 Receiving an incoming DSC TEST call reply (DSC TEST ACK)

1. When you receive notification of a DSC TEST reply, press **SILENC** softkey to silence the alert.
2. If the radio recognizes the user MMSI as one of your buddies, the buddy's name is displayed in place of the user MMSI.

5-11-3 Acknowledging an incoming DSC TEST call

The radio sounds a friendly two-tone alert when it detects an incoming DSC TEST call.

Note: If TEST REPLY is set to AUTO, no sound will be emitted.

1. If the radio recognizes the MMSI as one of your buddies, your buddy's name is displayed in place of the MMSI.
2. Press **SILENC** softkey to silence the alert.
3. The radio will automatically acknowledge the call if TEST REPLY is set to AUTO (See section 4-8-7) and after a TIMEOUT period set for AUTO REPLY (See section 4-8-8).

```
TEST
CALL FROM
TOM
▶ 00:01
```

```
TOM
AUTO ACK
IN 105
◀▶ 00:02
```

4. Alternatively, if TEST REPLY is set to MANUAL, a manual response is required, press **ACK** softkey to acknowledge the DSC Test Call.

```
TEST
CALL FROM
TOM
▶ 00:01
```

```
TOM
AUTO ACK
IS OFF
◀▶ 00:02
```

5. Press +/- button or rotate the CH knob to scroll any further information (if available), or press EXIT to cancel.

5-12 View User MMSI and GPS information

The radio's MMSI can be viewed as well as the current position.

```
DSC CALL
TRACK BUDD▲
DSC TEST
▶MMSI/GPS
```

```
ID:123456789
99°99.999'X
999°99.000'Y
```

5-13 Receiving DSC Calls

Several types of DSC calls can be received from vessels within range at various priority levels:

- **DISTRESS** See section 6.
- **ALL SHIPS** Urgency or Safety priority (see section 5-14)
- **INDIVIDUAL** Urgency, Safety, or Routine priority (see section 5-15)
- **GROUP** Routine priority only (see section 5-16)
- **GEOGRAPHIC** Routine priority only (see section 5-17)
- **POLLED POSITION** Routine or Safety priority (see section 5-18)

In addition to the audible alert, the telephone icon will flash on the screen.

This is to remind you that a call is stored in the CALL LOG. Polled position call data is NOT stored.

5-14 Receiving an All Ships Call (ALL SHIPS)

```
ALL SHIPS
SAFETY FROM
123456789
▶ 00:01
```

```
SAFETY FROM
123456789
CHANGE TO
◀▶ 00:11
```

1. When you receive notification of an ALL SHIPS call, press **SILENC** softkey to silence the alert. The priority level and the user MMSI are displayed on the screen. If the radio recognises the user MMSI as one of your buddies, the buddy name is shown in place of the user MMSI.
2. Press **ACCEPT** softkey to switch to the designated channel immediately. Press ◀ / ▶ keys to scroll any further information about the call, or press EXIT to return the current DSC receive process.
3. If the display shows "AUTO SWITCH", the radio will automatically switch to the designated channel after 10s if no user intervention. For "AUTO SW OFF", a manual change is required - for "AUTO SWITCH" options, see section 4-8-6.
4. Press PTT to initiate voice contact on current display channel.

The call data is stored in your Call Log (see section 5-7).

5-15 Receiving an Individual Call (INDIV)

```
INDIVIDUAL  
ROUTINE FROM  
123456789  
▶ 00:01
```

```
123456789  
NO AUTO SW  
CH06 REQUEST  
◀▶ 00:11
```

1. When you receive notification of an INDIV call, press **SILENC** softkey to silence the alert. INDIV calls are almost always routine priority. If the radio recognises the user MMSI as one of your buddies, the buddy's name is displayed in place of the user MMSI.
2. Press ◀/▶ keys to scroll any further information about the call, or press EXIT to return the current DSC receive process.
3. You have the following options to respond the call:
 - **ABLE** softkey respond to the call with requested channel
 - **NEW-CH** softkey respond to the call with but request a different channel
 - **UNABLE** softkey respond to the call with unable to use the requested channel (**Note:** this option is not available with ROUTINE calls)
4. If the display shows "AUTO SWITCH", the radio will automatically respond to the call after 10s if no user intervention. For "AUTO SW OFF", a manual response is required - for "INDIV REPLY" options, see section 4-8-3.
5. The caller should respond to your acknowledgement by making voice contact designated channel. If this does not happen, you can press PTT to initiate voice contact instead.

The call data is stored in your Call Log (see section 5-7).

5-16 Receiving a Group Call (GROUP)

```
GP: SAM  
CALL FROM  
123456789  
▼ 00:01
```

```
123456789  
CHANGE TO  
CH06  
◀▶ 00:11
```

1. When you receive notification of a GROUP call, press **SILENC** softkey to silence the alert. Press ◀/▶ keys to scroll any further information about the call.

The priority level is always routine, and the group is identified on the screen. The group will be one of the 20 groups of frequently called people that you set up earlier (see section 4-8-2).

2. Press **ACCEPT** softkey to switch to the designated channel immediately, or press EXIT to return the current DSC receive process.
3. If the display shows "AUTO SWITCH", the radio will automatically switch to the

designated channel after 10s if no user intervention. For "AUTO SW OFF", a manual change is required - for "AUTO SWITCH" options, see section 4-8-6.

4. You do not need to send an acknowledgement. If desired, press PTT to initiate voice contact on the designated channel.

The call data is stored in your Call Log (see section 5-7).

5-17 Receiving a Geographic Area Call (GEOGRAPH)

```
GEOGRAPHICAL  
CALL FROM  
123456789  
▶ 00:01
```

```
CALL FROM  
123456789  
CH06 REQUEST  
◀▶ 00:11
```

A geographic call is received by vessels within a specific geographic boundary area.

1. When you receive notification of a GEOGRAPHICAL call, press **SILENC** softkey to silence the alert. Then press **ACCEPT** softkey to manually select the channel designated in the incoming call.

The user MMSI or name is displayed on the screen. If the radio recognises the user MMSI as one of your buddies, the buddy's name is displayed in place of the user MMSI.

2. Press ◀/▶ keys to scroll any further information about the call, or press EXIT to return the current DSC receive process.
3. Monitor the working channel for an announcement from the calling vessel.

5-18 Receiving a Polled Position Call (POSITION)

```
POSITION  
REPLY FROM  
123456789  
▼ 00:01
```

When you receive GPS position data from a buddy in response to your LL request you are recommended to make a written note of the position, especially if it is a good fishing position.

If enhanced LL position information is available from your buddy, press **SILENC** softkey to silence the alert. Press ◀/▶ keys to scroll any further information about the call, or press EXIT to return the current DSC receive process.

Note: DSC & DSE sentence will be output on the NMEA 0183 port for indication on a connected chartplotter / MFD.

Section 6 - Distress calls



A valid USER MMSI must be entered into this radio before these DSC functions can be used. See section 5-1.

6-1 Send a Distress call

```
DISTRESS CALL
▶UNDEFINED
FIRE
FLOODING▼
```

```
DISTRESS CALL
▶UNDEFINED
HOLD DISTRESS
3 SECONDS...
```

```
DISTRESS CALL
SENDING...
WAITING GPS...
EXIT: 15S
```

```
DISTRESS CALL
UNDEFINED
11:23 UTC
▶TX IN 04:02
```

Important Note: If there is no current GNSS valid data when the distress alert is initiated, the equipment shall display that it is waiting for a GNSS position for 15 s and as soon as a fix is obtained then the alert shall be transmitted. The waiting GPS screen will not appear if there is already a valid GPS fix.

1. Open the red cover labelled DISTRESS.

If time is available to specify the nature of the distress, go to step 2. Otherwise, go directly to step 3.

2. Press and release the DISTRESS key to display the following categories. Press ▲ / ▼ keys to select the category that describes your situation:

- **UNDEFINED** (Undefined)
- **FIRE** (Fire)
- **FLOODING** (Flooding)
- **COLLISION** (Collision)
- **GROUNDING** (Grounding)
- **LISTING** (Listing)
- **SINKING** (Sinking)
- **ADRIFT** (Adrift)
- **ABANDONING** (Abandoning)
- **PIRACY** (Piracy)
- **OVER BOARD** (Overboard)

3. Press and hold down the **DISTRESS** key for about 3 seconds, until you see the distress call sending message (**DISTRESS CALL SENDING**) on the screen. The whole display starts to flash and beep loudly.
4. After the Distress Call is sent, the radio waits for an acknowledgment.
 - The Distress call is automatically transmitted every 3.5 to 4.5 minutes, until an acknowledgement is received (“Call repeat” mode).
 - Press ◀ / ▶ to display the transmitted Distress call information.
5. You now have the following options: **RESEND**, **PAUSE**, **CANCEL**:
6. To **RESEND** the call, press **RESEND** softkey to enter “**HOLD DISTRESS 3 SECONDS TO SEND**” screen. Hold down **DISTRESS** key for 3s to resend the call or press **EXIT** softkey to return to waiting for an acknowledgement call.
7. To **PAUSE** the call, press **PAUSE** softkey to pause the “Call repeat” mode, press **EXIT** softkey to resume the same call.
8. To **CANCEL** the call, press **CANCEL** softkey to enter “**DISTRESS CALL SEND CANCEL**” screen.
 - Press **NO** softkey to return to waiting for an acknowledgement call.
 - Press **YES** softkey to send the **DISTRESS CANCEL** call. Then press **PTT** to report your situation using the handset mic, after the report, press **EXIT** to return to the normal operating mode.
9. After receiving the acknowledgment, press **SILENC** softkey then reply using the microphone, or press **EXIT** key to quit the current distress acknowledgment.

Note: Prior to receiving an acknowledgement, the distress alert call cannot immediately be terminated by you, it can only be cancelled by completing the distress call cancel process as described above (step 8).

6-2 Receiving a Distress Call (DISTRESS!)

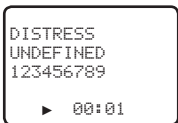

An alert sounds when a distress call (DISTRESS!) is received.

1. Press **SILENC** softkey to silence the alert. You do not need to send an acknowledgement.
2. The radio automatically selects CH16 after 10 seconds if no user intervention, or press **ACCEPT** softkey to change to CH16 immediately.
3. Press ◀/▶ button to view details of the distress call. Details include the user MMSI and nature of the emergency (if specified), also the time and the location (if specified). If the location and time are not specified, these are replaced with sequences of 9s and 8s respectively.
 - The radio is capable of receiving enhanced LL position data if the vessel transmitting the distress call is sending this. This provides the position of the distressed vessel to within 20 m (60 ft).
4. Press PTT to establish voice contact or press EXIT key to quit the DISTRESS RECEIVE call.

Note: The call data is stored in the Distress Log and location data (DSC & DSE) sentence will be output on the NMEA 0183 port for indication on a connected chartplotter / MFD.

6-3 Distress Acknowledgement (DISTRESS ACK) or Distress Relay All Ships (DISTRESS REL)

1. An alert sounds when a Distress ACK or Distress Relay all ship call is received. Press **SILENC** softkey to silence the alert.
2. The radio automatically selects CH16 after 10 seconds if no user intervention, or press **ACCEPT** softkey to change to CH16 immediately.
3. Press ◀ / ▶ button or rotate the CH knob to view details of the distress call. Details include the user MMSI and nature of the emergency (if specified), also the time and the location (if specified). If the location and time are not specified, these are replaced with sequences of 9s and 8s respectively.
4. Press PTT to make voice contact with the calling vessel. Maintain a listening watch on CH16 and standby to lend assistance.
 - For a Distress Acknowledgement (DISTRESS ACK) sent from the Search and Rescue (SAR) authorities of your country, your radio automatically cancels Distress Mode transmissions and CH16 appears. Press PTT to establish voice contact with the Search and Rescue (SAR) authority.

- The Search and Rescue (SAR) authorities of your country are the only instance allowed to send a Distress Acknowledgement (DISTRESS ACK).

5. Press EXIT key to quit the current DSC receive process.

Note: The call data is stored in the Distress Log and location data (DSC & DSE) sentence is sent on the NMEA 0183 port for indication on a connected chartplotter / MFD.

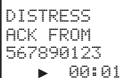

```
DISTRESS
ACK FROM
567890123
▶ 00:01
```

6-4 Distress Relay Individual (INDIV DISTR RELAY)

When an incoming Individual Distress Relay call is received, the alarm sounds and INDIV DISTR RELAY is displayed.

1. Press **SILENC** softkey to silence the alarm.
2. Press ◀/▶ keys to view details of the distress call. Details include the user MMSI and nature of the emergency (if specified), also the time and the location (if specified). If the location and time are not specified, these are replaced with sequences of 9s and 8s respectively.
3. ALL MODELS: Press **ACCEPT** softkey to immediately accept the channel change before the 10s timer expires
4. US MODELS: Press **ACK** softkey to ACK the call after the 10s delay - for "INDIV REPLY" options, see section 4-8-3.
5. Press EXIT key to quit current receive DSC process.

Note: The call data is stored in the Distress Log and location data (DSC & DSE) sentence is sent on the NMEA 0183 port for indication on a connected chartplotter / MFD.

Section 7 - Installation Instructions

7-1 Batteries and charger

The radio is shipped with a sealed Li-Polymer battery pack that is rechargeable.

WARNING

The charger provided for this radio is only to be used to charge the battery pack provided. **Do not** charge any other type of batteries in the charger as fire, explosion or battery damage could occur. Avoiding extreme room temperature will also help prolong the life of the battery pack for the radio.

7-1-1 Installing the battery pack

1. Position the battery pack to line up the three external alignment tabs to the alignment slots in the radio.
2. Engage the battery pack into the radio until battery pack is fully seated against the radio housing.
3. Pivot the locking tab up until it snaps into place on the back of the battery pack.

7-1-2 Initial charge

You can either charge the Li-Polymer battery pack when it is attached to the radio or separated:

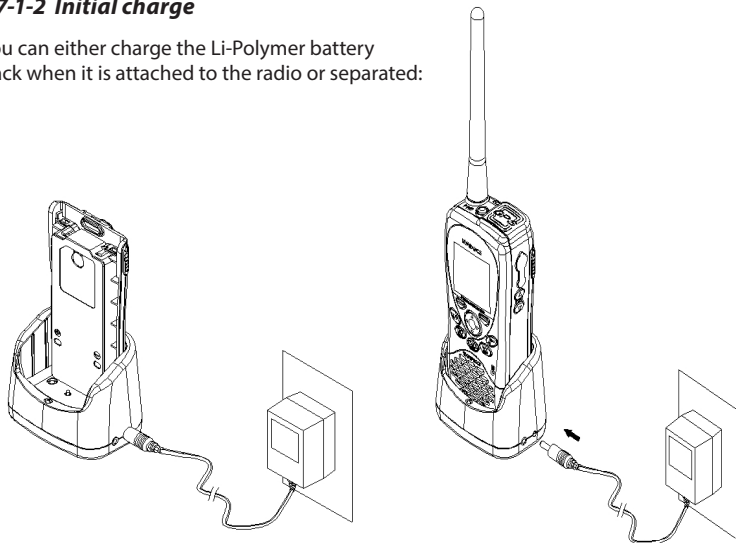

1. Plug in the AC/DC wall charger- check the voltage is correct for your wall charger.
2. Connect the charging wire into the charging socket on the cradle charger.
3. Insert the entire radio or the separated battery pack into the cradle charger. The metal charge contacts on the radio will contact the mating prongs in the charger to transfer the charging current.
4. Observe that the red light on the front of the charger glows to indicate that the battery pack is properly seated and the charger is operating.
5. Allow the battery to charge for about 2.5 to 3 hours before use. The light will change back to green when the battery is fully charged.

CAUTION

To maximise battery life: remove the battery from the charger after approximately 3.5 hours. Overcharging batteries may result in damage to both the battery pack and radio.

7-1-3 GPS connector

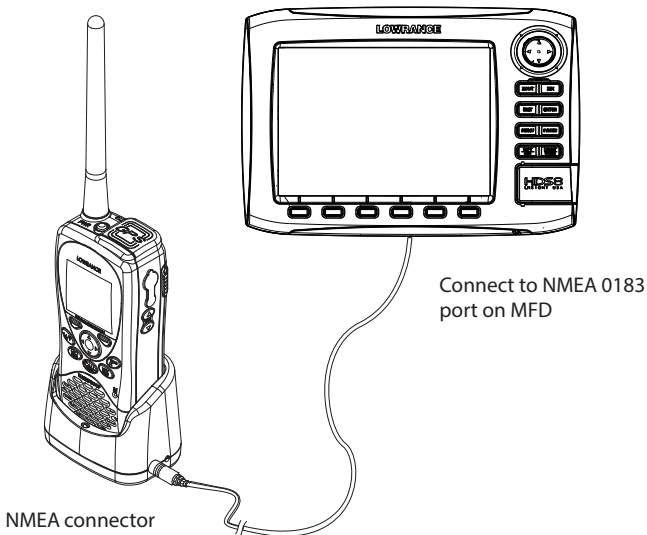

This radio supports NMEA 0183 for outputting the GPS signal. You can use the GPS connector to connect the radio and some GPS navigation receiver, such as chartplotter.

1. Insert the GPS connector cord into the NMEA socket of the cradle charger.
2. Connect the chartplotter to the VHF using the following wiring code:

Wire color	Function
Red	NMEA OUT (+)
Black	NMEA OUT (-)

7-1-4 Battery charger operation

Only the battery charger supplied with this radio must be used to charge the radio's battery. The charger is a smart charger with a LED indicating charge status.

LED color	Function
Red	The battery is connected and charging
Green	The battery is full / charge is complete
Red (flashing)	The battery is faulty or the temperature is too high

7-1-5 Mounting battery charger to flat surface

You can mount the battery charger straight onto solid surface. Make sure that the surface can be penetrated and is strong enough to hold permanently in place.

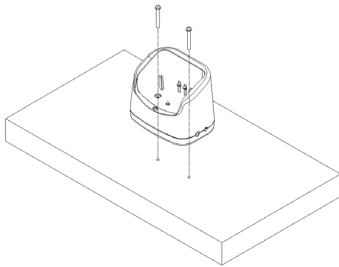

7-1-6 Mounting battery charger and bracket onto wall

You can also mount the battery charger onto wall by using the provided bracket and screws.

1. Mount the bracket as indicated in the diagram.
2. Attach the battery charger to the bracket using the screws provided.

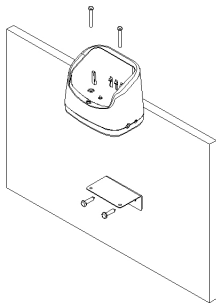

To remove the battery from the radio:

1. Slide the two levers (simultaneously) in a downward motion.
2. Remove battery.

7-2 Installing the belt clip

Slide the clip (2) into the recess on the back of the radio battery.

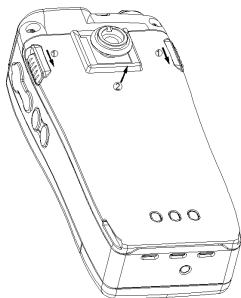

The belt clip supplied with your radio allows you to attach the radio to your belt. To install the belt clip: slide the belt clip to the back of your radio, make sure that the fitting groove is aligned.

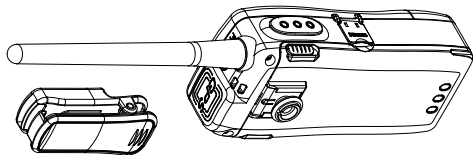

7-3 Installing and removing the antenna

Make sure that the flexible antenna is attached to the radio. Ensure that the radio is turned OFF anytime that the antenna is not connected.

Installing the antenna:

Screw the antenna in a clockwise motion until it is securely locked into place.

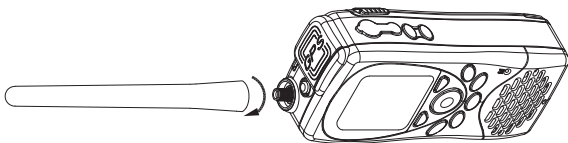

Removing the antenna:

Unscrew the antenna in a anti-clockwise motion until it is removed (as illustrated below).

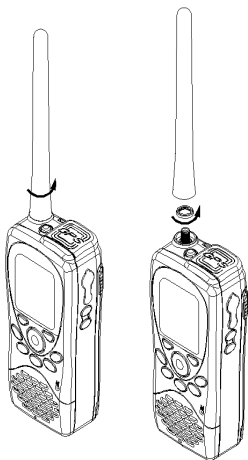

Note: Do not operate the radio or press PTT key without the antenna being installed.

WARNING

Never leave your radio in a closed car or trunk; the extremely high temperatures generated in hot weather can damage the electronics.

Appendix A - Technical specifications

Lowrance Link-2

A-1 General:

Waterproof	Floating and totally submersible to JIS-7
Channels	All US, Canadian and International Channels 10 NOAA Weather Channels
Frequency range	Transmit -156.025 to 157.425 MHz Receive - 156.025 to 163.275 MHz
Battery model	BP-10
Battery details	7.4 V,1400 mAh (10.36Wh), sealed Li-Polymer
Battery life	7 Hours (with GPS/DSC on and 5W 5/5/90% ratio)
Cradle charger type	BC-10
Cradle charger details	12V DC, 800mA0
Cradle charging current	500±100 mA with 4 hour rapid charge time
Antenna socket	SMA
DSC	CLASS-D
Display	128x128 pixel bit-mapped LCD with backlight

A-2 Receiver:

Sensitivity 12 dB SINAD	≤0.25 uV
Squelch sensitivity	0.20 uV
Adjacent channel selection	70 dB
Spurious response rejection	70 dB
Intermodulation rejection	68 dB
Audio power output	250 mW at 5% THD, 700 mW max

A-3 Transmitter:

Power output	1 or 5 Watts (selectable)
Modulation type	FM
Hum and noise attenuation	40 dB
Audio distortion	5%

Adjacent channel power	Less than 70 dB
Spurious/harmonic emissions	Less than 0.25uW
Current drain	Transmit (High) 1.75 A Transmit (Low) 0.8 A

A-4 GPS and Navigation:

Satellites tracked	12
Navigation	Great Circle navigation display with 300 waypoints
Plotter	12 range scales and 360 point of track history with interval control
Units	NM, SM, KM

A-5 Digital Selective Calling (DSC):

DSC type	CLASS-D
MMSI and NAME directory	20 numbers & groups
Dedicated distress key	Yes

A-6 Standards:

DSC – US models	ITU-R M.493-13
DSC – EU models	EN 300338-5
Other	EN 60950-1:2006 /A1:2010

A-7 Communications:

Comm. port	NMEA 0183, 4800 baud (when docked in cradle charger)
NMEA 0183 output (transmit):	DSC (for DSC call), DSE (for enhanced position). RMC, GGA, GLL, GSV at 1Hz

Appendix B - US & ROW VHF Marine Channel Charts

The following channel charts are provided for reference only and may not be correct for all regions. It is the operators responsibility to ensure correct channels and frequencies are used for local regulations.

B-1 International Channel Chart

CH	TX (MHz)	RX (MHz)	MODE	TRAFFIC TYPE	SHIP TO SHIP	SHIP TO SHORE	NAME TAG	REMARK
01	156.050	160.650	D	Public Correspondence	No	Yes	TELEPHONE	
02	156.100	160.700	D	Public Correspondence	No	Yes	TELEPHONE	
03	156.150	160.750	D	Public Correspondence	No	Yes	TELEPHONE	
04	156.200	160.800	D	Port Operations	No	Yes	PORT OPS	
05	156.250	160.850	D	Port Operations	No	Yes	PORT OPS/VTS	
06	156.300	156.300	S	Inter-ship Safety	Yes	No	SAFETY	
07	156.350	160.950	D	Port Operations	No	Yes	PORT OPS	
08	156.400	156.400	S	Commercial (inter-ship only)	Yes	No	COMMERCIAL	
09	156.450	156.450	S	Inter-ship	Yes	Yes	CALLING	
10	156.500	156.500	S	Commercial	Yes	Yes	COMMERCIAL	
11	156.550	156.550	S	Port Operations	Yes	Yes	VTS	
12	156.600	156.600	S	Port Operations	Yes	Yes	PORT OPS/VTS	
13	156.650	156.650	S	Inter-ship Navigation Safety (bridge-to bridge)	Yes	No	BRIDGE COM	
14	156.700	156.700	S	Port Operations	Yes	Yes	PORT OPS/VTS	
15	156.750	156.750	S	Port Operations	Yes	Yes	PORT OPS	⊙ 1W only
16	156.800	156.800	S	International Distress, Safety, and Calling	Yes	Yes	DISTRESS	
17	156.850	156.850	S	State Controlled	Yes	Yes	SAR	⊙ 1W only
18	156.900	161.500	D	Port Operations	No	Yes	PORT OPS	
19	156.950	161.550	D	Ship to Shore	No	Yes	SHIP-SHORE	
20	157.000	161.600	D	Port Operations	No	Yes	PORT OPS	
21	157.050	161.650	D	Port Operations	No	Yes	PORT OPS	
22	157.100	161.700	D	Port Operations	No	Yes	PORT OPS	
23	157.150	161.750	D	Public Correspondence	No	Yes	TELEPHONE	
24	157.200	161.800	D	Public Correspondence	No	Yes	TELEPHONE	
25	157.250	161.850	D	Public Correspondence	No	Yes	TELEPHONE	
26	157.300	161.900	D	Public Correspondence	No	Yes	TELEPHONE	
27	157.350	161.950	D	Public Correspondence	No	Yes	TELEPHONE	
28	157.400	162.000	D	Public Correspondence	No	Yes	TELEPHONE	
60	156.025	160.625	D	Public Correspondence	No	Yes	TELEPHONE	
61	156.075	160.675	D	Port Operations	No	Yes	PORT OPS	

62	156.125	160.725	D	Port Operations	No	Yes	PORT OPS	
63	156.175	160.775	D	Port Operations	No	Yes	PORT OPS	
64	156.225	160.825	D	Public Correspondence	No	Yes	TELEPHONE	
65	156.275	160.875	D	Port Operations	No	Yes	PORT OPS	
66	156.325	160.925	D	Port Operations	No	Yes	PORT OPS	
67	156.375	156.375	S	Commercial, bridge-to-bridge	Yes	No	BRIDGE COM	
68	156.425	156.425	S	Inter-ship	Yes	No	SHIP-SHIP	
69	156.475	156.475	S	Port Operations	Yes	Yes	PORT OPS	
70	156.525	156.525	-	Digital Selective Calling - DSC	-----	-----	DSC	Ⓣ
71	156.575	156.575	S	Port Operations	Yes	Yes	PORT OPS	
72	156.625	156.625	S	Inter-ship	Yes	No	SHIP-SHIP	
73	156.675	156.675	S	Port Operations	Yes	Yes	PORT OPS	
74	156.725	156.725	S	Port Operations	Yes	Yes	PORT OPS	
77	156.875	156.875	S	Ship to Shore	Yes	No	SHIP-SHORE	
78	156.925	161.525	D	Ship to Shore	No	Yes	SHIP-SHORE	
79	156.975	161.575	D	Port Operations	No	Yes	PORT OPS	
80	157.025	161.625	D	Port Operations	No	Yes	PORT OPS	
81	157.075	161.675	D	Public Correspondence	No	Yes	TELEPHONE	
82	157.125	161.725	D	Public Correspondence	No	Yes	TELEPHONE	
83	157.175	161.775	D	Public Correspondence	No	Yes	TELEPHONE	
84	157.225	161.825	D	Public Correspondence	No	Yes	TELEPHONE	
85	157.275	161.875	D	Public Correspondence	No	Yes	TELEPHONE	
86	157.325	161.925	D	Public Correspondence	No	Yes	TELEPHONE	
87	157.375	161.975	D	Public Correspondence	No	Yes	TELEPHONE	
88	157.425	162.025	D	Public Correspondence	No	Yes	TELEPHONE	

Special Notes on International Channel Usage

- ①. LOW POWER (1W) only.
- ②. Channel 70 is designated for use exclusively for Digital Selective Calling (DSC), such as Distress, Safety, and Ship Calls. No voice communication is allowed on CH70. This channel is only available on DSC enabled radios.

Note:

- The INTERNATIONAL channel bank is not legal for use in U.S. or Canada waters.
- Select the INTERNATIONAL channel bank for use in Australia, New Zealand and other Asia Pacific regions, and all other regions where otherwise not specified.

KEY: S = Simplex operating channel; D = Duplex operating channel.

B-2 USA Channel Chart

CH	TX (MHz)	RX (MHz)	MODE	TRAFFIC TYPE	SHIP TO SHIP	SHIP TO SHORE	NAME TAG	REMARK
01A	156.050	156.050	S	Port Operations, Selected VTS Areas	Yes	Yes	PORT OPS/VTS	
03A	156.150	156.150	S	US Government, Coast Guard	Yes	Yes	UNAUTHORIZED	④
05A	156.250	156.250	S	Port Operations, Selected VTS Areas	Yes	Yes	PORT OPS/VTS	
06	156.300	156.300	S	Inter-ship Safety	Yes	No	SAFETY	
07A	156.350	156.350	S	Commercial	Yes	Yes	COMMERCIAL	
08	156.400	156.400	S	Commercial (inter-ship only)	Yes	No	COMMERCIAL	
09	156.450	156.450	S	Recreational Calling Channel	Yes	Yes	CALLING	
10	156.500	156.500	S	Commercial	Yes	Yes	COMMERCIAL	
11	156.550	156.550	S	Commercial, VTS in Selected Areas	Yes	Yes	VTS	
12	156.600	156.600	S	Port Operations, Selected VTS Areas	Yes	Yes	PORT OPS/VTS	
13	156.650	156.650	S	Inter-ship Navigation Safety (bridge-to-bridge), 1W with Power-up	Yes	No	BRIDGE COM	③ 1W
14	156.700	156.700	S	Port Operations, Selected VTS Areas	Yes	Yes	PORT OPS/VTS	
15	---	156.750	S	Environmental	-----	-----	ENVIRONMENTAL	② RX only
16	156.800	156.800	S	International Distress, Safety, and Calling	Yes	Yes	DISTRESS	
17	156.850	156.850	S	State Controlled	Yes	Yes	SAR	① 1W only
18A	156.900	156.900	S	Commercial	Yes	Yes	COMMERCIAL	
19A	156.950	156.950	S	Commercial	Yes	Yes	COMMERCIAL	
20	157.000	161.600	D	Port Operations, Canadian Coast Guard	No	Yes	PORT OPS	
20A	157.000	157.000	S	Port Operations	Yes	Yes	PORT OPS	
21A	157.050	157.050	S	U.S. Government, Canadian Coast Guard	Yes	Yes	UNAUTHORIZED	④
22A	157.100	157.100	S	Coast Guard Liaison	Yes	Yes	COAST GUARD	
23A	157.150	157.150	S	U.S. Government, Coast Guard	Yes	Yes	UNAUTHORIZED	④
24	157.200	161.800	D	Public Correspondence, Marine operator	No	Yes	TELEPHONE	
25	157.250	161.850	D	Public Correspondence, Marine operator	No	Yes	TELEPHONE	
26	157.300	161.900	D	Public Correspondence, Marine operator	No	Yes	TELEPHONE	
27	157.350	161.950	D	Public Correspondence, Marine operator	No	Yes	TELEPHONE	
28	157.400	162.000	D	Public Correspondence, Marine operator	No	Yes	TELEPHONE	
61A	156.075	156.075	S	U.S. Government, Canadian Coast Guard	Yes	Yes	UNAUTHORIZED	④
63A	156.175	156.175	S	Port Operations, VTS in Selected Areas	Yes	Yes	PORT OPS/VTS	
64A	156.225	156.225	S	U.S. Government, Canadian Commercial Fishing	Yes	Yes	UNAUTHORIZED	④
65A	156.275	156.275	S	Port Operations	Yes	Yes	PORT OPS	
66A	156.325	156.325	S	Port Operations	Yes	Yes	PORT OPS	
67	156.375	156.375	S	Commercial, bridge-to-bridge, 1W with Power-up	Yes	No	BRIDGE COM	③ 1W

68	156.425	156.425	S	Boat Operations, Recreational	Yes	No	SHIP - SHIP	
69	156.475	156.475	S	Boat Operations, Recreational	Yes	Yes	PLEASURE	
70	156.525	156.525		Digital Selective Calling - DSC	-----	-----	DSC	Ⓞ
71	156.575	156.575	S	Boat Operations, Recreational	Yes	Yes	PLEASURE	
72	156.625	156.625	S	Boat Operations, Recreational	Yes	No	SHIP - SHIP	
73	156.675	156.675	S	Port Operations	Yes	Yes	PORT OPS	
74	156.725	156.725	S	Port Operations	Yes	Yes	PORT OPS	
77	156.875	156.875	S	Port Operations	Yes	Yes	PORT OPS	① 1W only
78A	156.925	156.925	S	Boat Operations, Recreational	Yes	No	SHIP - SHIP	
79A	156.975	156.975	S	Commercial	Yes	Yes	COMMERCIAL	
80A	157.025	157.025	S	Commercial	Yes	Yes	COMMERCIAL	
81A	157.075	157.075	S	U.S. Government, Environmental Protection Agency Operations	Yes	Yes	UNAUTHORIZED	④
82A	157.125	157.125	S	U.S. Government, Canadian Coast Guard	Yes	Yes	UNAUTHORIZED	④
83A	157.175	157.175	S	U.S. Government, Canadian Coast Guard	Yes	Yes	UNAUTHORIZED	④
84	157.225	161.825	D	Public Correspondence, Marine Operator	No	Yes	TELEPHONE	
84A	157.225	157.225	S	Public Correspondence, Marine Operator				
85	157.275	161.875	D	Public Correspondence, Marine Operator	No	Yes	TELEPHONE	
85A	157.275	157.275	S	Public Correspondence, Marine Operator				
86	157.325	161.925	D	Public Correspondence, Marine Operator	No	Yes	TELEPHONE	
86A	157.325	157.325	S	Public Correspondence, Marine Operator				
87	157.375	161.975	D	Public Correspondence, Marine Operator	No	Yes	TELEPHONE	
87A	157.375	157.375	S	Public Correspondence, Marine Operator				
88	157.425	162.025	D	Public Correspondence, Marine Operator	No	Yes	TELEPHONE	
88A	157.425	157.425	S	Commercial, Inter-ship Only	Yes	No	COMMERCIAL	

Special Notes on USA Channel Usage

- ①. LOW POWER (1 W) only.
- ②. Receive Only.
- ③. LOW POWER (1 W) initially. Override to HIGH POWER by holding down H/L key before transmitting. Used normally in bridge-to-bridge communications.
- ④. Lightly shaded simplex channels 03A, 21A, 23A, 61A, 64A, 81A, 82A, and 83A cannot be lawfully used in U.S. waters unless special authorization is obtained from the U.S. Coast Guard. Not for use by the general public.
- ⑤. The letter "A" illuminated by the channel number indicates the USA channel is simplex. This same channel is always duplex when selecting International. There is no "A" reference for International channels. The letter "B" is only used for some Canadian "Receive only" channels.
- Ⓞ. Channel 70 is designated for use exclusively for Digital Selective Calling (DSC), such as Distress, Safety, and Ship Calls. No voice communication is allowed on CH70. This channel is only available on DSC enabled radios.

KEY: S = Simplex operating channel; D = Duplex operating channel.

B-3 CANADA Channel Chart

CH	TX (MHz)	RX (MHz)	MODE	TRAFFIC TYPE	SHIP TO SHIP	SHIP TO SHORE	NAME TAG	REMARK
01	156.050	160.650	D	Public Correspondence	No	Yes	TELEPHONE	
02	156.100	160.700	D	Public Correspondence	No	Yes	TELEPHONE	
03	156.150	160.750	D	Public Correspondence	No	Yes	TELEPHONE	
04A	156.200	156.200	S	Canadian Coast Guard, SAR	Yes	Yes	CANADIAN CG	
05A	156.250	156.250	S	Port Operations, VTS in Selected Areas	Yes	Yes	PORT OPS/VTS	
06	156.300	156.300	S	Inter-ship Safety	Yes	No	SAFETY	
07A	156.350	156.350	S	Commercial	Yes	Yes	COMMERCIAL	
08	156.400	156.400	S	Commercial (inter-ship only)	Yes	No	COMMERCIAL	
09	156.450	156.450	S	Recreational Calling Channel	Yes	Yes	CALLING	
10	156.500	156.500	S	Commercial	Yes	Yes	COMMERCIAL	
11	156.550	156.550	S	Commercial, VTS in Selected Areas	Yes	Yes	VTS	
12	156.600	156.600	S	Port Operations, VTS in Selected Areas	Yes	Yes	PORT OPS/VTS	
13	156.650	156.650	S	Inter-ship Navigation Safety (bridge-to-bridge) 1W with power-up	Yes	No	BRIDGE COM	③ 1W
14	156.700	156.700	S	Port Operations, VTS in Selected Areas	Yes	Yes	PORT OPS/VTS	
15	156.750	156.750	S	Commercial	Yes	Yes	COMMERCIAL	① 1W only
16	156.800	156.800	S	International Distress, Safety, and Calling	Yes	Yes	DISTRESS	
17	156.850	156.850	S	State Controlled	Yes	Yes	SAR	① 1W only
18A	156.900	156.900	S	Commercial	Yes	Yes	COMMERCIAL	
19A	156.950	156.950	S	Canadian Coast Guard	Yes	Yes	CANADIAN CG	
20	157.000	161.600	D	Canadian Coast Guard	No	Yes	CANADIAN CG	① 1W only
21	157.050	161.650	D	Port Operations	No	Yes	PORT OPS	
21A	157.050	157.050	S	U.S. Government, Canadian Coast Guard	Yes	Yes	UNAUTHORIZED	
21B	---	161.650	S	Port Operations	-----	-----	PORT OPS	RX only
22A	157.100	157.100	S	Canadian Coast Guard Liaison	Yes	Yes	CANADIAN CG	
23	157.150	161.750	D	Public Correspondence	No	Yes	TELEPHONE	
24	157.200	161.800	D	Public Correspondence	No	Yes	TELEPHONE	
25	157.250	161.850	D	Public Correspondence	No	Yes	TELEPHONE	
25B	---	161.850	S	Public Correspondence	-----	-----	TELEPHONE	RX only
26	157.300	161.900	D	Public Correspondence	No	Yes	TELEPHONE	
27	157.350	161.950	D	Public Correspondence	No	Yes	TELEPHONE	
28	157.400	162.000	D	Public Correspondence	No	Yes	TELEPHONE	
28B	---	162.000	S	Public Correspondence	-----	-----	TELEPHONE	RX only
60	156.025	160.625	D	Public Correspondence	No	Yes	TELEPHONE	
61A	156.075	156.075	S	U.S. Government, Canadian Coast Guard	Yes	Yes	UNAUTHORIZED	④
62A	156.125	156.125	S	Canadian Coast Guard	Yes	Yes	CANADIAN CG	

64	156.225	160.825	D	Public Correspondence, Duplex	No	Yes	TELEPHONE	
64A	156.225	156.225	S	U.S. Government, Canadian Commercial Fishing	Yes	Yes	UNAUTHORIZED	④
65A	156.275	156.275	S	Port Operations	Yes	Yes	PORT OPS	
66A	156.325	156.325	S	Port Operations	Yes	Yes	PORT OPS	① 1W only
67	156.375	156.375	S	Commercial, SAR	Yes	No	COMMERCIAL	
68	156.425	156.425	S	Boat Operations, Recreational	Yes	No	SHIP - SHIP	
69	156.475	156.475	S	Commercial Fishing Only	Yes	Yes	COMMERCIAL	
70	156.525	156.525	S	Digital Selective Calling - DSC	-----	-----	DSC	⑥
71	156.575	156.575	S	Boat Operations, Recreational	Yes	Yes	PLEASURE	
72	156.625	156.625	S	Inter-ship	Yes	No	SHIP - SHIP	
73	156.675	156.675	S	Commercial Fishing Only	Yes	Yes	COMMERCIAL	
74	156.725	156.725	S	Commercial Fishing Only	Yes	Yes	COMMERCIAL	
77	156.875	156.875	S	Port Operations	Yes	Yes	PORT OPS	① 1W only
78A	156.925	156.925	S	Boat Operations, Recreational	Yes	No	SHIP - SHIP	
79A	156.975	156.975	S	Commercial	Yes	Yes	COMMERCIAL	
80A	157.025	157.025	S	Commercial	Yes	Yes	COMMERCIAL	
81A	157.075	157.075	S	U.S. Government Operations	Yes	Yes	UNAUTHORIZED	④
82A	157.125	157.125	S	U.S. Government, Canadian Coast Guard	Yes	Yes	UNAUTHORIZED	④
83	157.175	161.775	D	Canadian Coast Guard	Yes	Yes	CANADIAN CG	
83A	157.175	157.175	S	U.S. Government, Canadian Coast Guard	Yes	Yes	UNAUTHORIZED	④
83B	---	161.775	S	Canadian Coast Guard, RX Only	-----	-----	CANADIAN CG	
84	157.225	161.825	D	Public Correspondence, Marine Operator	No	Yes	TELEPHONE	
85	157.275	161.875	D	Public Correspondence, Marine Operator	No	Yes	TELEPHONE	
86	157.325	161.925	D	Public Correspondence, Marine Operator	No	Yes	TELEPHONE	
87	157.375	161.975	D	Public Correspondence, Marine Operator	No	Yes	TELEPHONE	
88	157.425	162.025	D	Public Correspondence, Marine Operator	No	Yes	TELEPHONE	

Special Notes on Canada Channel Usage

- ①. LOW POWER (1 W) only.
- ②. Receive Only.
- ③. LOW POWER (1 W) initially. Override to HIGH POWER by holding down H/L key before transmitting. Used normally in bridge-to-bridge communications.
- ④. Lightly shaded simplex channels 21A, 23A, 61A, 64A, 81A, 82A, and 83A cannot be lawfully used in Canada waters unless special authorization is obtained from the Canadian Coast Guard. Not for use by the general public.
- ⑤. The letter "A" illuminated by the channel number indicates the Canada channel is simplex. This same channel is always duplex when selecting International. There is no "A" reference for International channels. The letter "B" is only used for some Canadian "Receive only" channels.

- ⑥ Channel 70 is designated for use exclusively for Digital Selective Calling (DSC), such as Distress, Safety, and Ship Calls. No voice communication is allowed on CH70.
This channel is only available on DSC enabled radios.

Note: The CANADA mode is not legal to use in U.S. waters.

KEY: S = Simplex operating channel; D = Duplex operating channel.

B-4 US & Canada WEATHER Channels

CH	RX (MHz)	TRAFFIC TYPE	NAME	REMARK
WX01	162.550	NOAA Weather Channel	NOAA WX	RX only
WX02	162.400	NOAA Weather Channel	NOAA WX	RX only
WX03	162.475	NOAA Weather Channel	NOAA WX	RX only
WX04	162.425	NOAA Weather Channel	NOAA WX	RX only
WX05	162.450	NOAA Weather Channel	NOAA WX	RX only
WX06	162.500	NOAA Weather Channel	NOAA WX	RX only
WX07	162.525	NOAA Weather Channel	NOAA WX	RX only
WX08	161.650	CANADIAN Weather Channel	CANADA WX	RX only
WX09	161.775	CANADIAN Weather Channel	CANADA WX	RX only
WX10	163.275	NOAA Weather Channel	NOAA WX	RX only

B-5 EAS (Emergency Alert Systems) Alerts

National Codes Nature of Activation	Event Codes	Message
Emergency Action Notification (National only)	EAN	WARNING
	EAT	ADVISORY
National Information Center	NIC	ADVISORY
National Periodic Test	NPT	TEST
Required Monthly Test	RMT	TEST
Required Weekly Test	RWT	TEST

State and Local Codes Nature of Activation	Event Codes	Message
Avalanche Warning	AVW	WARNING
Avalanche Watch	AVA	WATCH
Blizzard Warning	BZW	WARNING
Child Abduction Emergency	CAE	WARNING
Civil Danger Warning	CDW	WARNING
Civil Emergency Message	CEM	WARNING
Coastal Flood Warning	CFW	WARNING
Coastal Flood Watch	CFA	WATCH
Dust Storm Warning	DSW	WARNING
Earthquake Warning	EQW	WARNING
Evacuation Immediate	EVI	WARNING
Fire Warning	FRW	WARNING
Flash Flood Warning	FFW	WARNING
Flash Flood Watch	FFA	WATCH
Flash Flood Statement	FFS	ADVISORY
Flood Warning	FLW	WARNING
Flood Watch	FLA	WATCH
Flood Statement	FLS	ADVISORY
Hazardous Materials Warning	HMW	WARNING
High Wind Warning	HWW	WARNING
High Wind Watch	HWA	WATCH

State and Local Codes Nature of Activation	Event Codes	Message
Hurricane Warning	HUW	WARNING
Hurricane Watch	HUA	WATCH
Hurricane Statement	HLS	ADVISORY
Law Enforcement Warning	LEW	WARNING
Local Area Emergency	LAE	WARNING
911 Telephone Outage Emergency	TOE	WARNING
Nuclear Power Plant Warning	NUW	WARNING
Radiological Hazard Warning	RHW	WARNING
Severe Thunderstorm Warning	SVR	WARNING
Severe Thunderstorm Watch	SVA	WATCH
Severe Weather Statement	SVS	ADVISORY
Shelter in Place Warning	SPW	WARNING
Special Marine Warning	SMW	WARNING
Special Weather Statement	SPS	ADVISORY
Tornado Warning	TOR	WARNING
Tornado Watch	TOA	WATCH
Tropical Storm Warning	TRW	WARNING
Tropical Storm Watch	TRA	WATCH
Tsunami Warning	TSW	WARNING
Tsunami Watch	TSA	WATCH
Volcano Warning	VOW	WARNING
Winter Storm Warning	WSW	WARNING
Winter Storm Watch	WSA	WATCH

For more information about the Emergency Alert System and event codes, visit:

http://www.nws.noaa.gov/os/eas_codes.shtml

Appendix C - EU VHF Marine Channel Charts

The following channel charts are provided for reference only and may not be correct for all regions. It is the operators responsibility to ensure correct channels and frequencies are used for local regulations. For specific channel information for your country, please refer to local authorities.

C-1 EU International Channel Chart

CH	TX (MHz)	RX (MHz)	MODE	TRAFFIC TYPE	SHIP TO SHIP	SHIP TO SHORE	NAME TAG	REMARK
01	156.050	160.650	D	Public Correspondence, Port Op	No	Yes	PHONE-PORTOP	
02	156.100	160.700	D	Public Correspondence, Port Op	No	Yes	PHONE-PORTOP	
03	156.150	160.750	D	Public Correspondence, Port Op	No	Yes	PHONE-PORTOP	
04	156.200	160.800	D	Public Correspondence, Port Op	No	Yes	PHONE-PORTOP	
05	156.250	160.850	D	Public Correspondence, Port Op	No	Yes	PHONE-PORTOP	
06	156.300	156.300	S	Inter-ship Safety	Yes	No	SAFETY	
07	156.350	160.950	D	Public Correspondence, Port Op	No	Yes	PHONE-PORTOP	
08	156.400	156.400	S	Commercial (inter-ship only)	Yes	No	SHIP-SHIP	
09	156.450	156.450	S	Inter-ship	Yes	Yes	SHIP-SHIP	
10	156.500	156.500	S	Inter-ship	Yes	Yes	SHIP-SHIP	
11	156.550	156.550	S	Port Operations	Yes	Yes	PORT OPS	
12	156.600	156.600	S	Port Operations	Yes	Yes	PORT OPS	
13	156.650	156.650	S	Inter-ship Navigation Safety (bridge-to bridge)	Yes	No	SAFETY COM	
14	156.700	156.700	S	Port Operations	Yes	Yes	PORT OPS	
15	156.750	156.750	S	Inter-ship	Yes	Yes	PORT OPS	⊙ 1W only
16	156.800	156.800	S	International Distress, Safety, and Calling	Yes	Yes	DISTRESS	
17	156.850	156.850	S	Inter-ship	Yes	Yes	PORT OPS	⊙ 1W only
18	156.900	161.500	D	Public Correspondence, Port Op	No	Yes	PHONE-PORTOP	
19	156.950	161.550	D	Public Correspondence, Port Op	No	Yes	PHONE-PORTOP	
20	157.000	161.600	D	Public Correspondence, Port Op	No	Yes	PHONE-PORTOP	
21	157.050	161.650	D	Public Correspondence, Port Op	No	Yes	PHONE-PORTOP	
22	157.100	161.700	D	Public Correspondence, Port Op	No	Yes	PHONE-PORTOP	
23	157.150	161.750	D	Public Correspondence, Port Op	No	Yes	PHONE-PORTOP	
24	157.200	161.800	D	Public Correspondence, Port Op	No	Yes	PHONE-PORTOP	
25	157.250	161.850	D	Public Correspondence, Port Op	No	Yes	PHONE-PORTOP	
26	157.300	161.900	D	Public Correspondence, Port Op	No	Yes	PHONE-PORTOP	
27	157.350	161.950	D	Public Correspondence, Port Op	No	Yes	PHONE-PORTOP	
28	157.400	162.000	D	Public Correspondence, Port Op	No	Yes	PHONE-PORTOP	
60	156.025	160.625	D	Public Correspondence, Port Op	No	Yes	PHONE-PORTOP	
61	156.075	160.675	D	Public Correspondence, Port Op	No	Yes	PHONE-PORTOP	

62	156.125	160.725	D	Public Correspondence, Port Op	No	Yes	PHONE-PORTOP	
63	156.175	160.775	D	Public Correspondence, Port Op	No	Yes	PHONE-PORTOP	
64	156.225	160.825	D	Public Correspondence, Port Op	No	Yes	PHONE-PORTOP	
65	156.275	160.875	D	Public Correspondence, Port Op	No	Yes	PHONE-PORTOP	
66	156.325	160.925	D	Public Correspondence, Port Op	No	Yes	PHONE-PORTOP	
67	156.375	156.375	S	Commercial, bridge-to-bridge	Yes	No	SHIP-SHIP	
68	156.425	156.425	S	Port Operations	Yes	No	PORT OPS	
69	156.475	156.475	S	Inter-ship	Yes	Yes	SHIP-SHIP	
70	156.525	156.525	-	Digital Selective Calling - DSC	-----	-----	DSC	②
71	156.575	156.575	S	Port Operations	Yes	Yes	PORT OPS	
72	156.625	156.625	S	Inter-ship	Yes	No	SHIP-SHIP	
73	156.675	156.675	S	Inter-ship	Yes	Yes	SHIP-SHIP	
74	156.725	156.725	S	Port Operations	Yes	Yes	PORT OPS	
75	156.775	156.775	S	Port Operations	Yes	Yes	PORT OPS	① 1W only
76	156.825	156.825	S	Port Operations	Yes	Yes	PORT OPS	① 1W only
77	156.875	156.875	S	Inter-ship	Yes	No	SHIP-SHIP	
78	156.925	161.525	D	Public Correspondence, Port Op	No	Yes	PHONE-PORTOP	
79	156.975	161.575	D	Public Correspondence, Port Op	No	Yes	PHONE-PORTOP	
80	157.025	161.625	D	Public Correspondence, Port Op	No	Yes	PHONE-PORTOP	
81	157.075	161.675	D	Public Correspondence, Port Op	No	Yes	PHONE-PORTOP	
82	157.125	161.725	D	Public Correspondence, Port Op	No	Yes	PHONE-PORTOP	
83	157.175	161.775	D	Public Correspondence, Port Op	No	Yes	PHONE-PORTOP	
84	157.225	161.825	D	Public Correspondence, Port Op	No	Yes	PHONE-PORTOP	
85	157.275	161.875	D	Public Correspondence, Port Op	No	Yes	PHONE-PORTOP	
86	157.325	161.925	D	Public Correspondence, Port Op	No	Yes	PHONE-PORTOP	
87	157.375	157.375	S	Port Operations	No	Yes	PORT OPS	③
88	157.425	157.425	S	Port Operations	No	Yes	PORT OPS	③

Special Notes on EU International Channel Usage

- ①. LOW POWER (1W) only.
- ②. Channel 70 is designated for use exclusively for Digital Selective Calling (DSC), such as Distress, Safety, and Ship Calls. No voice communication is allowed on CH70. This channel is only available on DSC enabled radios.
- ③. Maybe Duplex in some regions

KEY: S = Simplex operating channel; D = Duplex operating channel.

C-2 Inland Waterways Country Specific table - ATIS ON

For specific channel information for your country, please refer to local authorities.

CH	SPECIFIC FOOTNOTES	TRANSMITTING FREQUENCY (MHZ)		SHIP-TO-SHIP	SHIP-TO PORT	NAUTICAL INFORMATION
		SHIP	LAND			
60	a)	156.025	160.625			x
01	a)	156.05	160.65			x
61	a)	156.075	160.675			x
02	a)	156.1	160.7			x
62	a)	156.125	160.725			x
03	a)	156.15	160.75			x
63	a)	156.175	160.775			x
04	a)	156.2	160.8			x
64	a)	156.225	160.825			x
05	a)	156.25	160.85			x
65	a)	156.275	160.875			x
06	a) b)	156.3	156.3	x		
66	a)	156.325	160.925			x
07	a)	156.35	160.95			x
67	a) c)	156.375	156.375			x
08	a) q)	156.4	156.4	x		
68	a)	156.425	156.425			x
09	a) b) c)	156.45	156.45			x
69	a)	156.475	156.475			x
10	e)	156.5	156.5	x		
70	a)	156.525	156.525	Digital selective calling for distress, safety and calling		
11		156.55	156.55		x	
71		156.575	156.575		x	
12		156.6	156.6		x	
72	a) r)	156.625	156.625	x		
13	f)	156.65	156.65	x		
73	f) g)	156.675	156.675			x
14	q)	156.7	156.7		x	
74	a)	156.725	156.725		x	
15	h)	156.75	156.75			x
75	o)	156.775	156.775		x	
16	i)	156.8	156.8			x
76	j) d) o)	156.825	156.825			x
17	h)	156.85	156.85			x

77	a) k)	156.875	156.875	x		
18		156.9	161.5			x
78		156.925	161.525			x
19		156.95	161.55			x
79	a)	156.975	161.575			x
20		157	161.6			x
80		157.025	161.625			x
21	a)	157.05	161.65			x
81	a)	157.075	161.675			x
22		157.1	161.7			x
82	l) m)	157.125	161.725			x
23	m)	157.15	161.75			x
83	a) m)	157.175	161.775			x
24	m)	157.2	161.8			x
84	m)	157.225	161.825			x
25	m)	157.25	161.85			x
85	a) m)	157.275	161.875			x
26	m)	157.3	161.9			x
86	a) m)	157.325	161.925			x
27	m)	157.35	161.95			x
87	a) d)	157.375	157.375			x
28	m)	157.4	162			x
88	a) p)	157.425	157.425			x
ALS 1	a) n)	161.975	161.975			
ALS 2	a) n)	162.025	162.025			

General remarks to Country Specific table:

- 1 The channels for service categories ship-to-ship and nautical information may also be used for vessel traffic -systems by traffic centres.
- 2 In some countries, frequencies certain channels are used for an other service category or other radio services. These countries are Austria, Bulgaria, Croatia, the Federal Republic of Yugoslavia, Hungary, Moldova, Romania, the Russian Federation, the Slovak Republic, the Czech Republic (with exemption of channels 08, 09, 72, 74 and 86), Ukraine and the Federal Republic of Yugoslavia. The Administrations concerned should make any possible attempt to make these frequencies channels as soon as possible available for the radiotelephone service on Inland Waterways and/or the required service category.

Explanation of specific footnotes in Country Specific table:

- a. In the countries mentioned under remark 2, it is strictly prohibited to use this channel.
- b. This channel is not allowed to be used between Rhine km 150 and km 350.
- c. In the Netherlands, this channel is used by its on-scene communications during safety operations on the North Sea, IJsselmeer, Waddenzee, Ooster- and Westerschelde.
- d. This channel may also be used for piloting, mooring, tugging and for other nautical purposes.
- e. This channel is the first ship-to-ship channel, unless the competent authority has designated another channel. In the countries mentioned under remark 2, it is allowed that the output power is set to a value between 6 and 25 W until 1 January 2005.
- f. In the countries mentioned under remark 2, this channel is used for service category ship-to-port authorities.
- g. In the Netherlands, this channel is used by its national coastguard for communications during oil pollution operations on the North Sea and for safety messages for the North Sea, Waddenzee, IJsselmeer, Ooster- and Westerschelde.
- h. This channel may be used only for service category on-board communications.
- i. This channel may be used only for communications between seagoing vessels and participating land stations in case of distress and safety communications within the maritime sea-areas. In the countries mentioned under remark 2, this channel may be used only for distress, safety and calling.
- j. The output power shall be reduced automatically to a value between 0.5 and 1 W.
- k. This channel may be used for communications with a social character.
- l. In the Netherlands and Belgium, this channel may be used for transmitting messages concerning bunkering and victualling. The output power has to be reduced manually to a value between 0.5 and 1 W.
- m. This channel may also be used for public correspondence.
- n. This channel will be used for an automatic ship identification and surveillance system (AIS) capable of providing worldwide operating on seas and Inland Waterways.
- o. The availability of this channel is on a voluntary basis. All existing equipment shall be capable to of operating on this channel within a ten-year period after the entry into force of this Arrangement.
- p. After permission of the competent authority, this channel may be used only for special events on a temporary basis.
- q. In the Czech Republic this channel is used for service category nautical information.
- r. In the Czech Republic this channel is used for service category ship-to-port authorities.

C-3 Special Channels

Country	Item	Chart	Primary channel
EU Standard, France, Greece, Spain, Portugal	DSC ON	EUR Default	
UK	DSC ON	EUR Default	M, M2
Belgium	DSC ON	EUR Default	31, 37, 96 (1W)
	ATIS ON	EUR Default	31, 96 (1W)
Norway, Finland	DSC ON		L1, L2, L3, F1, F2, F3
Sweden, Denmark	DSC ON		L1, L2, F1, F2, F3
Italy	DSC ON		
Italy (with Coast)	DSC ON		A0, A1, A2, A3, A4, A5, A6, C0, C1, C2, C3, C4, C5, C6, C7, C8, C9
Holland	DSC ON		31 (1W), 37
	ATIS ON	EUR Default	31 (1W)
Germany	DSC ON		
	ATIS ON	EUR Default	
Austria	DSC ON	EUR Default	
	ATIS ON	EUR Default	

Countries of Intended use in the EU:

AT - Austria	HU - Hungary	PL - Poland
BE - Belgium	IS - Iceland	PT - Portugal
BG - Bulgaria	IE - Ireland	RO - Romania
CY - Cyprus	IT - Italy	SK - Slovakia
CZ - Czech Republic	LI - Liechtenstein	SI - Slovenia
DK - Denmark	LV - Latvia	ES - Spain
EE - Estonia	LT - Lithuania	SE - Sweden
FI - Finland	LU - Luxembourg	CH - Switzerland
FR - France	MT - Malta	TR - Turkey
DE - Germany	NL - Netherlands	UK - United Kingdom
GR - Greece	NO - Norway	



LOWRANCE®

CE1177ⓘ