

## HOW TO USE YOUR PARTS AND ACCESSORIES GUIDE

### Part and Packaging Information

#### Packaging and Unit Pricing

There are three different units of packaging for parts and accessories, they are:

1. Individually — Items that do not indicate any package quantity are priced and sold individually.
2. Priced individually, sold in specified quantity — When part numbers show the "@" sign, order the quantity you require. Orders will be rounded up to the next quantity.
3. Priced and packaged in quantities of a specified number — The items are sold in a specified case or package quantity. The quantities ordered should reflect the number of cases or packages you would like to purchase.

#### Part Classification

Part classification codes help to quickly identify a parts category. The following parts classification chart identify the part category use.

Part Classification Codes		
5 — Stern drives	39 — Piston rings	90 — Printed and advertising material
6 — Transom/gimbal housing	40 — Lock rings (piston pin)	91 — Tools and equipment
10 — Screws and bolts	41 — Piston pins	92 — Paint and lubricants
11 — Nuts	42 — Muffler	93 — Miscellaneous parts
12 — Washers (plain)	43 — Gears	97 — Anodes
13 — Washers (lock and wave)	44 — Propeller shafts	98 — Kits
14 — Washers (tab)	45 — Drive shafts	100 — Cowls and starter housings
15 — Shims	46 — Water pump cartridges	200 — Flywheels
16 — Studs	47 — Impellers	300 — Ignition components
17 — Pins and rivets	48 — Propellers	400 — Crankshafts
18 — Cotter pins	50 — Starters	500 — Center main bearings
19 — Welch plugs	51 — Cylinder liner	600 — Connecting rods
20 — Valves (shut-off)	52 — Clutches	700 — Pistons
21 — Check valves	53 — Rings (snap, "E", retaining)	800 — Cylinder blocks
22 — Fittings	54 — Clips and clamps	900 — Crankcases
23 — Bushings and spacers	55 — Shock absorbers	1000 — Cylinder block covers
24 — Springs	57 — V-belts	1100 — End caps and bearing housings
25 — O-rings and grommets	61 — Powerheads	1200 — Fuel tanks
26 — Seals	62 — Inflatable boat parts	1300 — Carburetors and components
27 — Gaskets	64 — Throttle, shift and steering	1400 — Clamps and swivel brackets
28 — Keys	67 — Boating accessories	1500 — Driveshaft housings
29 — Needle bearings	68 — Inflatable boat parts	1600 — Gear housings
30 — Ball bearings	79 — Instrument gauges	2100 — Cowls and starter housings
31 — Roller bearings	82 — Potentiometer	2400 — Cam shaft and crankshaft
32 — Lines (fuel, air, water)	83 — Varistors and rectifiers	2700 — Pistons
33 — Spark plugs	84 — Wiring harness and electrical cables	2800 — Cylinder blocks
34 — Reeds and reed stops	85 — Insulators	3300 — Carburetors and components
35 — Filters and strainers	86 — Connectors, terminals, terminal blocks	3400 — Clamp and swivel braces
36 — Filter caps	87 — Switches	3500 — Driveshaft housing
37 — Decals	88 — Fuses and light bulbs	3600 — Transmission
38 — Serial and name plates	89 — Solenoids	4000 — Cowls

#### Parts and Accessories Ordering Information

Brunswick Marine in EMEA recommends using Extranet for all product ordering, order status and Dealer account information. For all of your concerns on P&A ordering questions, please call your Customer Service representative.

## Mercury Precision, SmartCraft and Quicksilver Part and Accessories Limited Warranty

### What is Covered

Brunswick Marine in EMEA warrants each new or factory rebuilt Mercury Precision, SmartCraft, Quicksilver parts and accessories, and Mercury Racing Propellers sold by a Mercury authorized dealer or distributor, to be free from defects in material and workmanship during the period described following.

### Duration of Coverage

This limited warranty provides coverage for one year from either the date on which the product is first sold to a retail customer by a Mercury authorized dealer or distributor, or the date on which the product is first put into service, whichever occurs first.

Parts and accessories installed on Mercury Racing products that have product warranty duration of less than one year, carries a limited warranty coverage for a period of time equal to, and not greater than, the duration of the limited warranty originally provided with the parent product. The repair or replacement of parts, or the performance of service under this warranty, does not extend the life of this warranty beyond its original expiration date. Unexpired warranty coverage can be transferred to a subsequent purchaser upon proper re-registration of the product.

### Conditions That Must be Met in Order to Obtain Warranty Coverage

Warranty coverage is available only to retail customers that purchase from a dealer authorized by Brunswick Marine in EMEA to distribute the product in the country in which the sale occurred. Routine maintenance outlined in the Operation and Maintenance Manual must be timely performed in order to maintain warranty coverage. Brunswick Marine in EMEA reserves the right to make warranty coverage contingent upon proof of proper maintenance.

### What Mercury Will Do

Mercury's sole and exclusive obligation under this warranty is limited to, at our option, repairing a defective part, replacing such part or parts with new or refunding the purchase price of the Mercury product. Mercury reserves the right to improve or modify products from time to time without assuming an obligation to modify products previously manufactured.

### How to Obtain Warranty Coverage

The customer must provide Mercury with a reasonable opportunity to repair, and reasonable access to the product for warranty service. Warranty claims shall be made by delivering the product for inspection to a Mercury dealer authorized to service the product. If the purchaser cannot deliver the product to an authorized dealer, written notice must be given to Brunswick Marine in EMEA. We will then arrange for the inspection and any covered repair. The purchaser shall pay for all related transportation charges and travel time. If the service provided is not covered by this warranty, the purchaser shall pay for all related labor, material, and any other expenses associated with that service. The purchaser shall not, unless requested by Mercury, ship the product or parts of the product directly to Brunswick Marine in EMEA. The original purchase receipt establishes the warranty period and must be presented to the dealer at the time warranty service is requested in order to obtain coverage.

### What is Not Covered

This limited warranty does not cover routine maintenance items, tune ups, adjustments, normal wear, damage caused by abuse, abnormal use, double lab finished propellers, use of a propeller or gear ratio that does not allow the engine to run in its recommended wide open throttle RPM range (refer to the Operation and Maintenance Manual), operation of the product in a manner inconsistent with the recommended operation/duty cycle section of the Operation and Maintenance Manual, exceeding the horsepower limitations for the product as listed on the Mercury Racing propeller or in the Quicksilver Precision/Mercury Racing Accessory Guide, neglect, accident, submersion, improper installation (proper installation specifications are explained in the installation instructions for the product), improper service, use of an accessory or part not manufactured or sold by Brunswick Marine in EMEA, jet pump impellers and liners, operation with fuels, oils or lubricants which are not suitable for use with the product (refer to the Operation and Maintenance Manual), alteration or removal of parts, water entering the engine through the fuel intake, air intake or exhaust system, or damage to the product from insufficient cooling water caused by blockage of the cooling system by a foreign body, running the engine out of water, mounting the engine too high on the transom, or running the boat with the engine trimmed out too far. Use of the product for racing or other competitive activity, or operating with a racing type lower unit, at any point, even by a prior owner of the product voids the warranty.

Mercury Precision, SmartCraft and Quicksilver Parts and Accessories that are used for any purpose for which they are not intended (outside anticipated marine applications) are excluded from coverage under this warranty statement. Expenses related to haul-out, launch, towing, storage, telephone, rental, inconvenience, slip fees, insurance coverage, loan payments, loss of time, loss of income, or any other type of incidental or consequential damages are not covered by this warranty. Also, expenses associated with the removal and/or replacement of boat partitions or material caused by boat design for access to the product are not covered by this warranty.

No individual or entity, including Brunswick Marine in EMEA authorized dealers, has been given authority by Brunswick Marine in EMEA to make any affirmation, representation or warranty regarding the product, other than those contained in this limited warranty, and if made, shall not be enforceable against Brunswick Marine in EMEA. For additional information regarding events and circumstances covered by this warranty, and those that are not, see the Warranty Coverage section of the Operation and Maintenance Manual, incorporated by reference into this warranty.

### Disclaimers and Limitations

THE IMPLIED WARRANTIES OF MERCHANTABILITY AND FITNESS FOR A PARTICULAR PURPOSE ARE EXPRESSLY DISCLAIMED. TO THE EXTENT THAT THEY CANNOT BE DISCLAIMED, THE IMPLIED WARRANTIES ARE LIMITED IN DURATION TO THE LIFE OF THE EXPRESS WARRANTY. INCIDENTAL AND CONSEQUENTIAL DAMAGES ARE EXCLUDED FROM COVERAGE UNDER THIS WARRANTY. SOME COUNTRIES DO NOT ALLOW FOR THE DISCLAIMERS, LIMITATIONS AND EXCLUSIONS IDENTIFIED ABOVE, AS A RESULT, THEY MAY NOT APPLY TO YOU. THIS WARRANTY GIVES YOU SPECIFIC LEGAL RIGHTS, AND YOU MAY ALSO HAVE OTHER LEGAL RIGHTS WHICH VARY FROM COUNTRY TO COUNTRY.

## ExtraNET

ExtraNET is Brunswick Marins exclusive on-line system that will provide you access to the tools that will make your business efficient and profitable. Our electronic systems are intended to meet the needs of your business, large or small. The system allows you to perform functions faster and more accurately, enter orders, access product and warranty information more efficiently and much more. ExtraNET customers enjoy extra benefits, such as:

- Create orders for parts & accessories, certain finished products like outboards, inflatable boats, etc.
- Browse product configurator
- Check part and product availability
- View product history by serial number
- View order status and print invoices, statements and age analysis
- File product registration and consult pipeline
- File warranty claims
- Parts and products ordering 7 days a week
- File product protection plans

All ExtraNET systems are subject to change, as we continue to improve our products based on customer input.

## Electronic Parts Catalog

The Electronic Parts Catalog (EPC) containing the Mercury Parts Catalogs and Service Bulletins is available for ExtraNET customers in DVD format. Features of the Electronic Parts Catalog include:

- Easy access to part number and service bulletin retrieval
- Easy access to information by product line and serial number
- Create and import pick list to orders and claims
- Access footnotes in special comment section
- Current information available with quarterly updates

## MIDAS Pricebook for Parts

MIDAS Pricebook for Parts allows you to access product and part item pricing and information off-line. The MIDAS Pricebook for Parts can be downloaded from ExtraNET. The base MIDAS Pricebook file is updated annually and supported by weekly updates available in ExtraNET Handy Tools by selecting Update Pricebook. Features of the Pricebook for Parts include:

- Off-line access to part number pricing, supersession information and part status.
- Easy access to active part number information.
- Ability to update pricing weekly through ExtraNET or from the Pricebook.





**TABLE OF CONTENTS**

<b>Ignition</b> .....	2	<b>Mechanical Fuel Pump Repair Chart</b> .....	66
Brushes .....	10	<b>Cooling System</b> .....	92
CDM Assemblies .....	9	Outboard Thermostats & Temperature Sender ...	115
Condenser .....	2	Outboard Water Impeller Repair Kits - Early	
Distributor Caps .....	10	Mariner .....	101
<b>Ignition Charts - 2-Cycle Standard</b>		Outboard Water Impeller Repair Kits - Mercury/	
<b>Components</b> .....	13	Mariner .....	98
<b>Ignition Charts - FourStroke Standard</b>		Outboard Water Pump Impeller - Early Mariner ...	97
<b>Components</b> .....	10	Outboard Water Pump Impeller - Force .....	97
Ignition Coil .....	2	Outboard Water Pump Impeller - Mercury/	
Points .....	2	Mariner .....	94
Rotors .....	10	Outboard Water Pump Kits - Complete .....	92
Switchbox .....	7	Outboard Water Pump Upper Housings .....	102
<b>Electrical System</b> .....	23	Outboard Water Pump Upper Repair Kits .....	94
Battery Cables .....	23	<b>Water Pump Repair Charts</b> .....	104
Electrical Harness Repair Components .....	58	<b>Rewind Starter</b> .....	118
Electrical Harness Seal Kit .....	61	<b>Starter Rope and Recoil Spring Charts</b> .....	118
Rectifier .....	23	<b>Powerhead Components</b> .....	120
Relays - Power Trim .....	46	<b>Gasket Set Application Charts - Powerhead</b> ...	129
<b>Solenoid and Relay Chart - Mercury/Mariner</b> ...	48	Gasket Sets - Early Mariner .....	126
Solenoids - Starter & Power Trim .....	45	Gasket Sets - Mercury/Mariner Powerhead .....	120
Starter Motors & Component Parts .....	38	Head Gaskets .....	127
<b>Starter Motors and Components Charts</b> .....	43	Head Sealing O-Rings .....	126
Stator .....	24	Hose Clamp Kit .....	120
<b>Stator Application Chart - Mercury/Mariner</b> ...	29	<b>Gear Case Components</b> .....	138
Voltage Regulators .....	23	Front Water Inlet Plug Kits .....	139
Wiring Harness .....	24	<b>Lower Unit Seal Kit Application Charts</b> .....	143
<b>Fuel System</b> .....	63	Lower Unit Seal Kits .....	139
Carburetor Diaphragm Kits .....	80	Point of Sale Drain Screws and Seals .....	138
Carburetor Gaskets & Gasket Kits .....	72		
<b>Carburetor Repair Charts</b> .....	85		
Carburetor Repair Kits - Early Mariner .....	79		
Carburetor Repair Kits - Mercury/Mariner .....	76		
Check Valve Kits .....	63		
Floats .....	83		
Fuel Pump Diaphragm Kits .....	64		
Inlet Needle Assemblies .....	81		

# IGNITION

## IGNITION

### POINTS

#### POINTS



336- 4318A 2

#### POINTS



F12044

### CONDENSER

#### CONDENSER



394- 1130A 1

#### CONDENSER



811598

### CONDENSER



F12139-1

### CONDENSER



F12181-1

### IGNITION COIL

#### IGNITION COIL



398- 173

#### IGNITION COIL

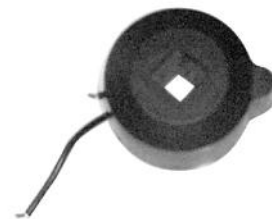

398- 2568T 1

IGNITION COIL



336- 4409A 4

IGNITION COIL



16064006

IGNITION COIL

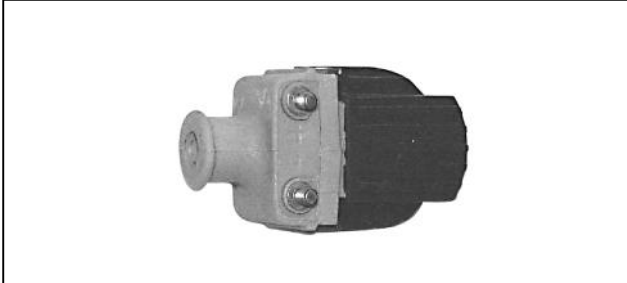

336- 4528T 2

IGNITION COIL



339-803559A02

IGNITION COIL

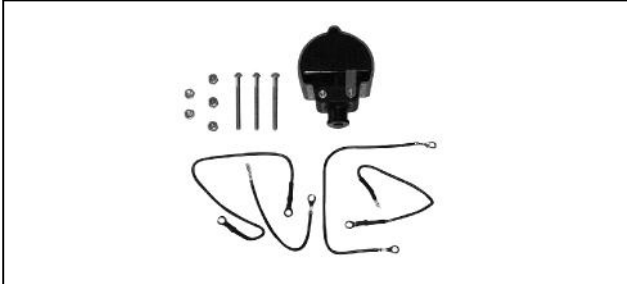

332- 4895A 5

IGNITION COIL



339-803559T 1

IGNITION COIL



332- 4895T 2

IGNITION COIL



339-803559T07

IGNITION COIL



339- 5288T 2

**IGNITION**

**IGNITION COIL**



**803559T08**

2.5/3.5 hp. FourStroke outboards beginning with s/n 0R318096 & above.

**IGNITION COIL**



**339-804271T**

**IGNITION COIL**



**815113T02**

**IGNITION COIL**



**823033**

**IGNITION COIL**



**339-825101T**

**IGNITION COIL**



**339-830404T 3**

**IGNITION COIL**



**339-832757A 4**

**IGNITION COIL**



**855685T**

**IGNITION COIL**



**339-856991A 1**

**IGNITION COIL**



**339-858942T 1**

**IGNITION COIL**



**339-859738T 1**

**IGNITION COIL**



**339-877807A 2**

**IGNITION COIL**



**339-879147T1**

Fits the F15/20 FourStroke outboards beginning with serial number JPN, 0R235168 and above.

**IGNITION COIL**



**339-8M0077471**

Fits the 75/90/115 (3 cylinder) OptiMax outboard beginning in Model Year 2004, and various V-6 2-cycle outboards. See application chart. Also fits MCM 600SCi.

**PENCIL COIL**



**339-880615T01**

**IGNITION COIL**



**339-880892001**

**IGNITION COIL**



**339-880892T**

**IGNITION**

**IGNITION COIL**



**339-880893T10**

**IGNITION COIL**



**339-8M0077473**

**IGNITION COIL**



**339-888309**

**IGNITION COIL**



**339-898103T**

**IGNITION COIL**



**898103T58**

2.5/3.5 hp. FourStroke outboards, 0R131842-0R318095.

**IGNITION COIL**



**898253T24**

Uses External Resistor

Fits MCM 4 cyl., V-6 & V-8 engines with conventional ignition and some outboard applications.

**IGNITION COIL**



**300-8M0044991**

Fits the F40/50/60 FourStroke (EFI, 4 cylinder) outboard beginning with serial number CHN 1C104424 and newer. Also fits MCM 4.5L V6.

**IGNITION COIL**



**300-8M0045124**

Fits the F40 FourStroke (EFI, 3 cylinder) outboard beginning with serial number CHN 1C104334 and newer.

**IGNITION COIL KIT**



**8M0047313**

**SWITCH BOX ASSY.**

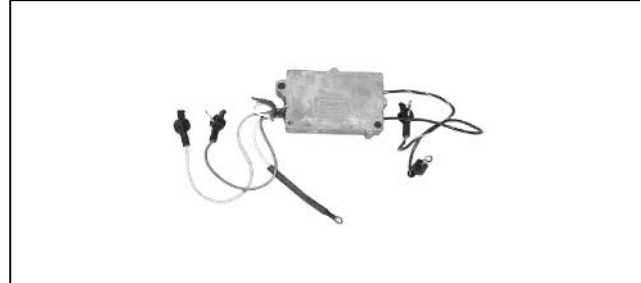

**332- 4911A 2**

**SWITCHBOX**

**SWITCH BOX ASSY.**



**332- 2986A21**

**SWITCH BOX ASSY.**



**332- 4911A 8**

**SWITCH BOX ASSY.**



**332- 2986A27**

For Thunderbolt ignition

**SWITCH BOX ASSY.**



**332- 5772A 7**

Used on 4 cylinder in-line outboards with ADI ignition systems. See application chart for specific models.

**SWITCH BOX ASSY.**

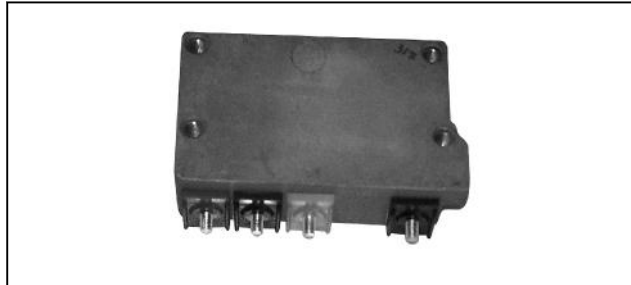

**333- 3213A 3**

**SWITCH BOX ASSY.**



**339- 6222A 8**

# IGNITION

**SWITCH BOX ASSY.**



339- 7452A19

**SWITCH BOX ASSY.**



339- 7452A21

**SWITCH BOX ASSEMBLY**



332- 7778A12

Used on various 3 & 6 cylinder outboards with ADI ignition systems. See the application chart for specific models.

**CDI UNIT**



16061T04

**SWITCH BOX ASSY.**

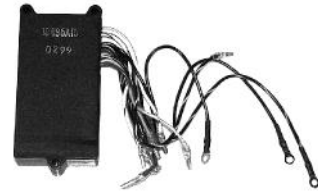

18495A26

**SWITCH BOX ASSY.**



19052A 8

**CDI UNIT**



803558T02

**CDI UNIT**



804269T 2

**CDI UNIT**



823034T



**CDI UNIT**



**835401T 1**

**SWITCH BOX ASSY.**

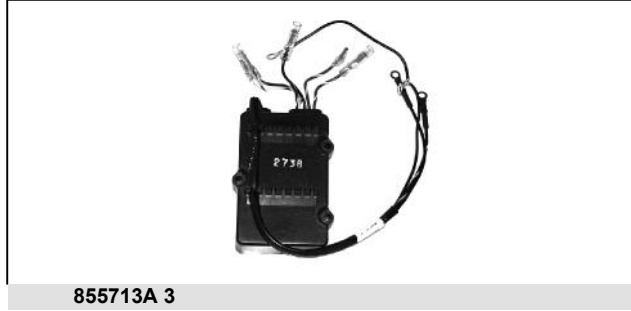

**855713A 3**

**SWITCH BOX ASSY.**

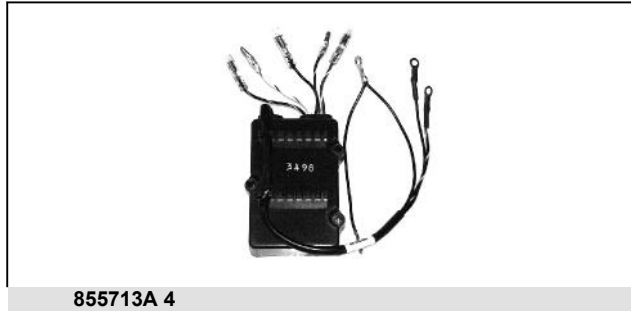

**855713A 4**

**CDI UNIT**



**835401T06**

Fits the F15/20 FourStroke outboards beginning with serial number JPN, 0R235168 and above.

**SWITCH BOX ASSY.**



**899883229**

**CDM ASSEMBLIES**

**CDM ADAPTER KIT**



**827509A12**

**CDM MODULE ASSY.**



**827509T 7**

**CDM MODULE ASSY.**



**827509A10**

# IGNITION

## DISTRIBUTOR CAPS

### GASKET



27- 25725

### GASKET

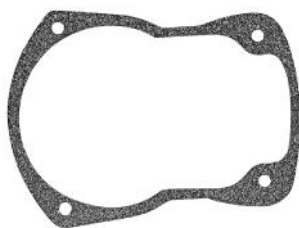

27- 29166

### GASKET

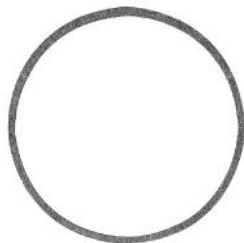

27- 55896

Priced individually, sold @ multiples of 3

## ROTORS

### ROTOR



393- 1280A 1

## BRUSHES

### BRUSH KIT



393- 1293A 1

Priced individually, sold @ multiples of 2

## IGNITION CHARTS - FOURSTROKE STANDARD COMPONENTS

Standard ignition component charts are located within this section. ECM modules and their application chart will be located in a separate section of its own.

### FourStroke Ignition Chart

Model	Model Notes	Serial # Range	Ignition Coil	Switch Box or TPM Ass'y
2.5 FourStroke		JPN 0R131842 - 0R318095	898103T58	N/A
2.5 FourStroke		JPN 0R318096 and up	803559T08	N/A
3.5 FourStroke		JPN 0R131842 - 0R318095	898103T58	N/A
3.5 FourStroke		JPN 0R318096 and up	803559T08	N/A
4 FourStroke		JPN 0R000001 - 0R067089	339-803559T 1	803558T02
		BEL 0P073456 - 0P400999		
4 FourStroke		JPN 0R067090 - 0R411837	339-803559T07	N/A
		BEL 0P401000 - 0R411837		
5 FourStroke		JPN 0R000001 - 0R067089	339-803559T 1	803558T02

Model	Model Notes	Serial # Range	Ignition Coil	Switch Box or TPM Ass'y
		BEL 0P073456 - 0P400999		
5 FourStroke		JPN 0R067090 - 0R411837	339-803559T07	N/A
		BEL 0P401000 - 0R411837		
5 FourStroke		JPN 0R411838 and up	8M0056379	N/A
6 FourStroke		JPN 0R000001 - 0R067089	339-803559T 1	803558T02
		BEL 0P073456 - 0P400999		
6 FourStroke		JPN 0R067090 - 0R411837	339-803559T07	N/A
		BEL 0P401000 - 0R411837		
6 FourStroke		JPN 0R411838 and up	8M0056379	N/A
8 FourStroke	Bodensee	USA 0G760300 - 0T178499	N.L.A.	N.L.A.
		USA 0H017100 - 0H017349		
8 FourStroke	323cc	BEL 0P075166 - 0P325499	855685T	835401T 1
8 FourStroke	209cc	USA 0R042475 and up	339-803559A02	835401T02
		BEL 0P325500 and up		
9.9 FourStroke	232cc	USA 0H000058 - 0H016909	N.L.A.	N.L.A.
9.9 FourStroke	323cc	USA 0G760300 - 0T979999	855685T	835401T 1
		BEL 0P075166 - 0P325499		
9.9 FourStroke	209cc	JPN 0R042475 and up	339-803559A02	835401T02
		BEL 0P325500 and up		
15 FourStroke	323cc	USA 0G760300 - 1B727495	855685T	835401T 1
		BEL 0P075166 and up		
15 FourStroke	351cc	JPN 0R235949 and up	339-879147T71	835401T06
20 FourStroke	351cc	JPN 0R235168 and up	339-879147T71	835401T06
25 FourStroke	Carb	USA 0G590000 - 1B344298	339-859738T 1	ECM
		BEL 9973100 - 0P388282		
25 FourStroke	EFI	JPN 0R106999 and up	339-898103T	ECM
25 JET	FourStroke EFI	JPN 0R106999 and up	339-898103T	ECM
30 FourStroke	Carb	USA 0G760300 - 0G960499	339-830404T 3	ECM
30 FourStroke	Carb	USA 0G960500 and up	339-858942T 1	ECM
		BEL 0P153500 and up		
30 FourStroke	EFI	USA 0T409000 - 0T979999	339-877807A 2	ECM
		BEL 0P153500 - 0P325499		
30 FourStroke	EFI	USA 0T980000 - 1B226999	339-8M0077471	ECM
		BEL 0P325500 - 0P400999		
30 FourStroke	EFI	JPN 0R106999 and up	339-898103T	ECM
40 FourStroke	Carb, 3 cylinder	USA 0G760300 - 0G960499	339-830404T 3	ECM
40 FourStroke	Carb, 3 cylinder	USA 0G960500 and up	339-858942T 1	ECM
		BEL 0P153500 and up		
		CHN 1C000001 and up		
40 FourStroke	EFI, 3 cylinder	USA 0T409000 - 0T979999	339-877807A 2	ECM
		BEL 0P153500 - 0P325499		
40 FourStroke	EFI, 3 cylinder	USA 0T980000 - 1B344398	339-8M0077471	ECM
		BEL 0P325500 - 0P515896		
		CHN 1C000001 - 1C104333		
40 FourStroke	EFI, 3 cylinder	CHN 1C104334 and up	300-8M0045124	ECM
40 FourStroke	Carb, 4 cylinder	USA 0T228405 - 0T598999	339-859738T 1	ECM
		BEL 0P094500 - 0P206999		
40 FourStroke	EFI, 4 cylinder	USA 0T409000 - 0T979999	339-877807A 2	ECM
		BEL 0P153500 - 0P325499		
40 FourStroke	EFI, 4 cylinder	USA 0T980000 - 1B344398	339-8M0077471	ECM
		BEL 0P325500 and up		
		CHN 1C000001 - 1C104423		
40 FourStroke	EFI, 4 cylinder	CHN 1C104424 and up	300-8M0044991	ECM
45 FourStroke	Bodensee	USA 0G231123 - 0T178499	339-825101T	ECM

**Not all parts listed are available for the European, C.I.S., Africa and Middle East Markets.**  
**For more information, please contact your local Mercury, Mariner, MerCruiser or Quicksilver Office.**

# IGNITION

Model	Model Notes	Serial # Range	Ignition Coil	Switch Box or TPM Ass'y
50 FourStroke		USA 0G231123 - 0T178499	339-825101T	ECM
50 FourStroke	Carb, 4 cylinder, 996cc	USA 0T178500 - 0T598999	339-859738T 1	ECM
		BEL 0P094500 - 0P206999		
50 FourStroke	EFI, 4 cylinder, 996cc	USA 0T409000 - 0T979999	339-877807A 2	ECM
		BEL 0P153500 - 0P325499		
50 FourStroke	EFI, 4 cylinder, 996cc	USA 0T980000 - 1B344398	339-8M0077471	ECM
		BEL 0P325500 and up		
		CHN 1C000001 - 1C104423		
50 FourStroke	EFI, 4 cylinder, 996cc	CHN 1C104424 and up	300-8M0044991	ECM
60 FourStroke	Carb, 4 cylinder, 996cc	USA 0T178500 - 0T598999	339-859738T 1	ECM
		BEL 0P094500 - 0P206999		
60 FourStroke	EFI, 4 cylinder, 996cc	USA 0T409000 - 0T979999	339-877807A 2	ECM
		BEL 0P153500 - 0P325499		
60 FourStroke	EFI, 4 cylinder, 996cc	USA 0T980000 - 1B344398	339-8M0077471	ECM
		BEL 0P325500 and up		
		CHN 1C000001 - 1C104423		
60 FourStroke	EFI, 4 cylinder, 996cc	CHN 1C104424 and up	300-8M0044991	ECM
75 FourStroke	Carb	USA 0G960500 - 1B226999	339-804271T	804269T 2
75 FourStroke	EFI, 1596cc	USA 1B172291 - 1B366822	339-880892001	ECM
75 FourStroke	EFI, 1741cc	USA 1B366823 - 2B094995	339-880615T01	ECM
80 FourStroke	EFI, 1741cc	BEL 0P459572 and up	339-880615T01	ECM
75/80 FourStroke	2.1L	USA 2B094996 and up	300-8M0044991	ECM
90 FourStroke		USA 0G960500 - 1B226999	339-804271T	804269T 2
90 FourStroke	EFI, 1596cc	USA 1B172291 - 1B366822	339-880892001	ECM
90 FourStroke	EFI, 1741cc	USA 1B366823 - 2B094995	339-880615T01	ECM
100 FourStroke	EFI, 1741cc	BEL 0P459572 and up	339-880615T01	ECM
90/100 FourStroke	2.1L	USA 2B094996 and up	300-8M0044991	ECM
115 FourStroke	EFI, Top Coil	USA 0T178500 - 1B366822	339-880892T	ECM
115 FourStroke	EFI, Bottom Coil	USA 0T178500 - 1B366822	339-880893T10	ECM
115 FourStroke	EFI, 1741cc	USA 1B366823 - 2B094995	339-880615T01	ECM
115 FourStroke	2.1L	USA 2B094996 and up	300-8M0044991	ECM
135 Verado	4 cylinder	USA 1B227000 and up	339-880615T01	ECM
		BEL 0P419487 and up		
150 FourStroke	EFI	USA 1B905505 and up	300-8M0044991	ECM
150 Verado	4 cylinder	USA 1B227000 and up	339-880615T01	ECM
		BEL 0P419487 and up		
175 Verado	4 cylinder	USA 1B227000 and up	339-880615T01	ECM
		BEL 0P419487 and up		
200 Verado	4 cylinder	USA 1B517159 and up	339-880615T01	ECM
		BEL 0P514869 and up		
200 Verado	6 cylinder	USA 0T980000 and up	339-880615T01	ECM
		BEL 0P409357 and up		
225 FourStroke	EFI	USA 0T653945 and up	339-888309	ECM
225 Verado	6 cylinder	USA 0T980000 and up	339-880615T01	ECM
		BEL 0P409357 and up		
250 Verado	6 cylinder	USA 0T980000 and up	339-880615T01	ECM
		BEL 0P409357 and up		
275 Verado	6 cylinder	USA 0T980000 and up	339-880615T01	ECM
		BEL 0P409357 and up		
300 Verado	6 cylinder	USA 1B517434 and up	339-880615T01	ECM
		BEL 0P520553 and up		
350Sci Verado	6 cylinder	USA 1B716557 and up	339-880615T01	ECM

**IGNITION CHARTS - 2-CYCLE STANDARD COMPONENTS**

Standard ignition component charts are located within this section. ECM modules and their application chart will be located in a separate section of its own.

**2-Cycle Ignition Chart**

Model	Serial # Range	Points	Condenser	Ignition Coil	Switch Box or TPM Ass'y	CDM Ass'y	Second CDM Ass'y	Distributor Cap	Rotor	Brush
2.2M	0A8075603 and up	N.L.A.	811598	N.L.A.	N/A	N/A	N/A	N/A	N/A	N/A
2.5 (Point ignition w/FOT0137 flywheel casting)	0A855097 and up	N.L.A.	811598	N.L.A.	N/A	N/A	N/A	N/A	N/A	N/A
2.5 (Point ignition w/FOT30071 flywheel casting)	0A855097 and up	N.L.A.	811598	N.L.A.	N/A	N/A	N/A	N/A	N/A	N/A
2.5 (CD Ignition)	USA 0A855097 and up BEL OP017000 and up	N/A	N/A	823033	823034T	N/A	N/A	N/A	N/A	N/A
3 (Point ignition w/FOT0137 flywheel casting)	0A855097 and up	N.L.A.	811598	N.L.A.	N/A	N/A	N/A	N/A	N/A	N/A
3 (Point ignition w/FOT30071 flywheel casting)	0A855097 and up	N.L.A.	811598	N.L.A.	N/A	N/A	N/A	N/A	N/A	N/A
3 (CD Ignition)	0A855097 and up	N/A	N/A	823033	823034T	N/A	N/A	N/A	N/A	N/A
3.3	USA 0D901217 and up BEL OP017000 and up	N/A	N/A	823033	823034T	N/A	N/A	N/A	N/A	N/A
3.5 (KF3)(Phelon ignition)	358136 - 358615	N.L.A.	N.L.A.	398- 173	N/A	N/A	N/A	N/A	N/A	N/A
3.5 (KF3)(Scintilla ignition)	358136 - 358615	N.L.A.	N.L.A.	N.L.A.	N/A	N/A	N/A	N/A	N/A	N/A
3.5	USA 6202173 and up	N/A	N/A	N.L.A.	N/A	N/A	N/A	N/A	N/A	N/A
3.6 (Water cooled)	USA 5404657 and up BEL 9252831 and up CAN 7145388 and up	N/A	N/A	N.L.A.	N/A	N/A	N/A	N/A	N/A	N/A
3.9 (39)	1655013 - 2498155	N.L.A.	N.L.A.	398- 2568T 1	N/A	N/A	N/A	N/A	N/A	N/A
4 ( 1 cyl.)	USA 2498136 - 2693114	N.L.A.	N.L.A.	398- 2568T 1	N/A	N/A	N/A	N/A	N/A	N/A
4 ( 1 cyl.)	USA 2771622 - 0A809600 AUS 3306257 and up BEL 9000306 - 9477829 CAN 3305152 and up	336- 4318A 2N/A		336- 4409A 4	N/A	N/A	N/A	N/A	N/A	N/A
4 ( 1 cyl.) A	USA 0A809601 and up BEL 9477830 and up	N/A	N/A	815113T02	16061T04	N/A	N/A	N/A	N/A	N/A
4 (40, 4, Gnat)(2 cyl.)	USA 5589202 and up AUS 8065265 and up BEL 9075839 and up CAN 7085673 and up	N/A	N/A	339- 5288T 2	339- 6222A 8	N/A	N/A	N/A	N/A	N/A
4.5 (1 cyl.)	USA 4107220 and up AUS 8026540 and up BEL 9072179 and up CAN 7045758 and up	336- 4318A 2N.L.A.		336- 4528T 2	N/A	N/A	N/A	N/A	N/A	N/A
5 (KF5)(Phelon ignition)	338136 and up	N.L.A.	N.L.A.	398- 173	N/A	N/A	N/A	N/A	N/A	N/A
5 (KF5)(Scintilla ignition)	338136 and up	N.L.A.	N.L.A.	N.L.A.	N/A	N/A	N/A	N/A	N/A	N/A
5 (MARK 5)(Phelon ignition)	574128 - 786612	N.L.A.	N.L.A.	398- 173	N/A	N/A	N/A	N/A	N/A	N/A
5 (MARK 5)(Phelon ignition)	574128 - 786612	N.L.A.	N.L.A.	N.L.A.	N/A	N/A	N/A	N/A	N/A	N/A
5 ( 1 cyl.)	USA 0A809601 and up BEL 9477830 and up	N/A	N/A	815113T02	16061T04	N/A	N/A	N/A	N/A	N/A
5.9 (MARK 6)(Phelon Ignition)	888005 - 1134535	N.L.A.	N.L.A.	398- 173	N/A	N/A	N/A	N/A	N/A	N/A
5.9 (MARK 6)(Scintilla Ignition)	888005 - 1134535	N.L.A.	N.L.A.	N.L.A.	N/A	N/A	N/A	N/A	N/A	N/A
6 (MARK 6A)(Phelon Ignition)	1184570 and up	N.L.A.	N.L.A.	398- 173	N/A	N/A	N/A	N/A	N/A	N/A
6 (MARK 6A)(Scintilla Ignition)	1184570 and up	N.L.A.	N.L.A.	N.L.A.	N/A	N/A	N/A	N/A	N/A	N/A
6 (60)	1408611 - 1610264	N.L.A.	N.L.A.	398- 173	N/A	N/A	N/A	N/A	N/A	N/A
6 (60)	1610265 - 2529894	N.L.A.	N.L.A.	398- 2568T 1	N/A	N/A	N/A	N/A	N/A	N/A

**Not all parts listed are available for the European, C.I.S., Africa and Middle East Markets.**  
**For more information, please contact your local Mercury, Mariner, MerCruiser or Quicksilver Office.**

# IGNITION

Model	Serial # Range	Points	Condenser	Ignition Coil	Switch Box or TPM Ass'y	CDM Ass'y	Second CDM Ass'y	Distributor Cap	Rotor	Brush
6	USA 0A197112 - 0G760299	N/A	N/A	339-832757A 4	339- 7452A19	N/A	N/A	N/A	N/A	N/A
	BEL 9461526 - 0P016999									
6	USA 0G760300 - 0T800749	N/A	N/A	339-832757A 4	855713A 4	N/A	N/A	N/A	N/A	N/A
	BEL 0P017000 and up									
7.5 (KE4, KG4, MARK 7)(Phelon ignition)	214324 and up	N.L.A.	N.L.A.	398- 173	N/A	N/A	N/A	N/A	N/A	N/A
7.5 (KE4, KG4, MARK 7) (Scintilla ignition)	214324 and up	N.L.A.	N.L.A.	N.L.A.	N/A	N/A	N/A	N/A	N/A	N/A
7.5 (75)	2529895 - 2721150	N.L.A.	N.L.A.	398- 2568T 1	N/A	N/A	N/A	N/A	N/A	N/A
7.5 (75)	2810637 - 3274632	336- 4318A 2	N/A	336- 4409A 4	N/A	N/A	N/A	N/A	N/A	N/A
7.5 (75)	3274633 - 3801457	336- 4318A 2	N.L.A.	336- 4528T 2	N/A	N/A	N/A	N/A	N/A	N/A
7.5 (7.5, 75)	USA 3801458 and up	N/A	N/A	339- 5288T 2	899883229	N/A	N/A	N/A	N/A	N/A
	AUS 8015315 and up									
	BEL 9043194 and up									
	CAN 7028598 and up									
8	USA 0A197112 - 0G760299	N/A	N/A	339-832757A 4	339- 7452A19	N/A	N/A	N/A	N/A	N/A
	BEL 9461526 - 0P016999									
8	USA 0G760300 and up	N/A	N/A	339-832757A 4	855713A 4	N/A	N/A	N/A	N/A	N/A
	BEL 0P017000 and up									
8T Sea Pro	BEL 0N014717 and up	N/A	N/A	N/A	803704T01	N/A	N/A	N/A	N/A	N/A
9.8 (110)	1470349 - 1865778	N.L.A.	N.L.A.	398- 173	N/A	N/A	N/A	N/A	N/A	N/A
9.8 (110)	1865778 - 2708898	N.L.A.	N.L.A.	398- 2568T 1	N/A	N/A	N/A	N/A	N/A	N/A
9.8 (110)	2798057 - 3263262	336- 4318A 2	N/A	336- 4409A 4	N/A	N/A	N/A	N/A	N/A	N/A
9.8 (110)	3263263 - 3795657	336- 4318A 2	N.L.A.	336- 4528T 2	N/A	N/A	N/A	N/A	N/A	N/A
9.8 (9.8, 110)	USA 3795658 and up	N/A	N/A	339- 5288T 2	899883229	N/A	N/A	N/A	N/A	N/A
	AUS 8015040 and up									
	BEL 9041439 and up									
	CAN 7027323 and up									
9.8T	BEL 0N007788 - 0N055109	N/A	N/A	N/A	803704T01	N/A	N/A	N/A	N/A	N/A
9.9	USA 0A197112 - 0G760299	N/A	N/A	339-832757A 4	339- 7452A19	N/A	N/A	N/A	N/A	N/A
	BEL 9461526 - 0P016999									
9.9	USA 0G760300 and up	N/A	N/A	339-832757A 4	855713A 4	N/A	N/A	N/A	N/A	N/A
	BEL 0P017000 and up									
10 (KE7, KF7, KG7)(Phelon)		N.L.A.	N.L.A.	398- 173	N/A	N/A	N/A	N/A	N/A	N/A
10 (KE7, KF7, KG7)(Scintilla)		N.L.A.	N.L.A.	N.L.A.	N/A	N/A	N/A	N/A	N/A	N/A
10 (MARK 10A)	1120828 - 1122327	N.L.A.	N.L.A.	398- 173	N/A	N/A	N/A	N/A	N/A	N/A
10 (MARK 15)	595628 and up	N.L.A.	N.L.A.	398- 173	N/A	N/A	N/A	N/A	N/A	N/A
10 (100)	1290910 - 1455239	N.L.A.	N.L.A.	398- 173	N/A	N/A	N/A	N/A	N/A	N/A
10 (XR10/Sea Pro 10, Magnum, Marathon)	USA 0D038000 - 0G760299	N/A	N/A	339-832757A 4	339- 7452A19	N/A	N/A	N/A	N/A	N/A
	BEL 9596000 - 0P016900									
10 (Sea Pro 10, Marathon)	USA 0G760300 and up	N/A	N/A	339-832757A 4	855713A 3	N/A	N/A	N/A	N/A	N/A
	BEL 0P017000 and up									
10 (XR10/Magnum, Viking)	USA 0G760300 and up	N/A	N/A	339-832757A 4	855713A 4	N/A	N/A	N/A	N/A	N/A
	BEL 0P017000 and up									
15 (150)	1200114 - 1499331	N.L.A.	N.L.A.	398- 173	N/A	N/A	N/A	N/A	N/A	N/A
15	USA 0B292414 - 0G760299	N/A	N/A	339-832757A 4	339- 7452A19	N/A	N/A	N/A	N/A	N/A
	BEL 9542620 - 0P016999									
15	USA 0G760300 and up	N/A	N/A	339-832757A 4	855713A 4	N/A	N/A	N/A	N/A	N/A
	BEL 0P017000 and up									
15T	BEL 0N001590 and up	N/A	N/A	8M0047313	803704T	N/A	N/A	N/A	N/A	N/A
15 (Sea Pro, Marathon)(Super)	USA 0G044027 - 0G437999	N/A	N/A	339-832757A 4	18495A30(4)	N/A	N/A	N/A	N/A	N/A
	BEL 9807909 - 9926999									

Model	Serial # Range	Points	Condenser	Ignition Coil	Switch Box or TPM Ass'y	CDM Ass'y	Second CDM Ass'y	Distributor Cap	Rotor	Brush
15 (Sea Pro, Marathon)(Super)	USA 0G438000 - 0G760299 BEL 9927000 - 0P016999	N/A	N/A	339-832757A 4	339- 7452A19	N/A	N/A	N/A	N/A	N/A
15 (Sea Pro, Marathon)	USA 0G760300 and up BEL 0P017000 and up	N/A	N/A	339-832757A 4	855713A 3	N/A	N/A	N/A	N/A	N/A
15XD Sea Pro/Marathon BigFoot	BEL 9927000 and up	N/A	N/A	339-832757A 4	339- 7452A19	N/A	N/A	N/A	N/A	N/A
15 (Super)(Commercial)	USA 0G760300 and up BEL 0P017000 and up	N/A	N/A	339-832757A 4	855713A 3	N/A	N/A	N/A	N/A	N/A
15 (Super)(Non-Commercial)	USA 0G760300 and up BEL 0P017000 and up	N/A	N/A	339-832757A 4	855713A 4	N/A	N/A	N/A	N/A	N/A
15XD Sea Pro/Marathon(Commercial)	USA 0G760300 and up BEL 0P017000 and up	N/A	N/A	339-832757A 4	855713A 3	N/A	N/A	N/A	N/A	N/A
15XD Sea Pro/Marathon(Non-Commercial)	USA 0G760300 and up BEL 0P017000 and up	N/A	N/A	339-832757A 4	855713A 4	N/A	N/A	N/A	N/A	N/A
16 (MARK 20)		N.L.A.	N.L.A.	N.L.A.	N/A	N/A	N/A	N/A	N/A	N/A
18	USA 5837437 - 6443972 AUS 8071973 and up BEL 9308306 - 9415100 CAN 7173723 - 7209532	N/A	N/A	339-832757A 4	N.L.A.	N/A	N/A	N/A	N/A	N/A
18XD with nut style connections	USA 6443973 and up BEL 9378151 and up CAN 7209533 and up	N/A	N/A	339-832757A 4	N.L.A.	N/A	N/A	N/A	N/A	N/A
18XD with bullet style connections	USA 6443973 and up BEL 9378151 and up CAN 7209533 and up	N/A	N/A	339-832757A 4	339- 7452A19	N/A	N/A	N/A	N/A	N/A
20 (MARK 25, MARK 25E)	860979 and up	N.L.A.	N.L.A.	398- 173	N/A	N/A	N/A	N/A	N/A	N/A
20 (200)	1558310 - 1592567	N.L.A.	N.L.A.	398- 173	N/A	N/A	N/A	N/A	N/A	N/A
20 (200)	1592568 - 2827676	N.L.A.	N.L.A.	398- 2568T 1	N/A	N/A	N/A	N/A	N/A	N/A
20 (200)	2827677 - 3226957	336- 4318A 2	N/A	336- 4409A 4	N/A	N/A	N/A	N/A	N/A	N/A
20 (200)	3226958 - 3537530	336- 4318A 2	N.L.A.	336- 4528T 2	N/A	N/A	N/A	N/A	N/A	N/A
20 (200)	USA 3537531 - 3755884 AUS 8006265 - 8013704 BEL 9016254 - 9035128 CAN 7012358 - 7024647	N/A	N/A	339-832757A 4	332- 4911A 2	N/A	N/A	N/A	N/A	N/A
20 (200)	USA 3755885 - 4403786 AUS 8013705 - 8039074 BEL 9035129 - 9122764 CAN 7024648 - 7077247	N/A	N/A	339- 5288T 2	332- 4911A 2	N/A	N/A	N/A	N/A	N/A
20 (200)	USA 4403787 - 6443972 AUS 8039075 - 9415100 BEL 9122765 - 9807907 CAN 7077248 - 7209532	N/A	N/A	339- 5288T 2	899883229	N/A	N/A	N/A	N/A	N/A
20 (20, 20XD)	USA 6443973 - 0G044026 BEL 9415101 - 9807908 CAN 7209533 and up	N/A	N/A	339-832757A 4	339- 7452A19	N/A	N/A	N/A	N/A	N/A
20	USA 0G044027 - 0G437999 BEL 9807909 - 9926999	N/A	N/A	339-832757A 4	18495A30(4)	N/A	N/A	N/A	N/A	N/A
20	USA 0G438000 - 0G760299 BEL 9927000 - 0P016999	N/A	N/A	339-832757A 4	339- 7452A19	N/A	N/A	N/A	N/A	N/A
20 (Commercial)	USA 0G760300 - 0T800999 BEL 0P017000 and up	N/A	N/A	339-832757A 4	855713A 3	N/A	N/A	N/A	N/A	N/A
20 (Non-Commercial)	USA 0G760300 - 0T800999	N/A	N/A	339-832757A 4	855713A 4	N/A	N/A	N/A	N/A	N/A

**Not all parts listed are available for the European, C.I.S., Africa and Middle East Markets.  
For more information, please contact your local Mercury, Mariner, MerCruiser or Quicksilver Office.**

# IGNITION

Model	Serial # Range	Points	Condenser	Ignition Coil	Switch Box or TPM Ass'y	CDM Ass'y	Second CDM Ass'y	Distributor Cap	Rotor	Brush
	BEL 0P017000 and up									
20 JET	USA 0G044027 - 0G760299	N/A	N/A	339-832757A 4	18495A30(4)	N/A	N/A	N/A	N/A	N/A
	BEL 9807909 - 0P016999									
20 JET	USA 0G760300 and up	N/A	N/A	339-832757A 4	855713A 3	N/A	N/A	N/A	N/A	N/A
	BEL 0P017000 and up									
22 (MARK 22A)	1158546 - 1499331	N.L.A.	N.L.A.	398- 173	N/A	N/A	N/A	N/A	N/A	N/A
25 (KF9)	377150 - 379008	N.L.A.	394- 1130A 1	N.L.A.	N/A	N/A	N/A	N.L.A.	N.L.A.	N.L.A.
25 (KG9)	377150 - 379008	N.L.A.	394- 1130A 1	N.L.A.	N/A	N/A	N/A	N.L.A.	N.L.A.	N.L.A.
25 (MARK 40)	377150 - 379008	N.L.A.	394- 1130A 1	N.L.A.	N/A	N/A	N/A	N.L.A.	N.L.A.	N.L.A.
25 (250)	1200114 - 1499331	N.L.A.	N.L.A.	398- 173	N/A	N/A	N/A	N/A	N/A	N/A
25 (2 cyl.)	USA 5705532 - 6443972	N/A	N/A	339-832757A 4	N.L.A.	N/A	N/A	N/A	N/A	N/A
	AUS 8073158 and up									
	BEL 9315316 - 9415100									
	CAN 7166928 - 7209532									
25XD with nut style connections	USA 6443973 and up	N/A	N/A	339-832757A 4	N.L.A.	N/A	N/A	N/A	N/A	N/A
	BEL 9378151 and up									
	CAN 7209533 and up									
25XD with bullet style connections	USA 6443973 and up	N/A	N/A	339-832757A 4	339- 7452A19	N/A	N/A	N/A	N/A	N/A
	BEL 9378151 and up									
	CAN 7209533 and up									
25 (2 cyl.)	USA 0B238464 - 0G044026	N/A	N/A	339-832757A 4	339- 7452A19	N/A	N/A	N/A	N/A	N/A
	BEL 9507381 - 9807908									
	CAN 0A730007 and up									
25 (2 cyl.)	USA 0G044027 - 0G437999	N/A	N/A	339-832757A 4	18495A30(4)	N/A	N/A	N/A	N/A	N/A
	BEL 9807909 - 9926999									
25 (2 cyl.)	USA 0G438000 - 0G760299	N/A	N/A	339-832757A 4	339- 7452A19	N/A	N/A	N/A	N/A	N/A
	BEL 9927000 - 0P016999									
25 (Commercial)	USA 0G760300 and up	N/A	N/A	339-832757A 4	855713A 3	N/A	N/A	N/A	N/A	N/A
	BEL 0P017000 and up									
25 (Non-Commercial)	USA 0G760300 and up	N/A	N/A	339-832757A 4	855713A 4	N/A	N/A	N/A	N/A	N/A
	BEL 0P017000 and up									
25 (3 cyl.)	USA 0E268781 and up	N/A	N/A	N.L.A.	N/A	N/A	N/A	N/A	N/A	N/A
30 (MARK 30, MARK 55)		N.L.A.	394- 1130A 1	N.L.A.	N/A	N/A	N/A	N.L.A.	N.L.A.	N.L.A.
30 (300)	1271884 - 144139	N.L.A.	394- 1130A 1	N.L.A.	N/A	N/A	N/A	N.L.A.	N.L.A.	N.L.A.
30 (2 cyl.) 644cc	USA 0G053314 - 0G380074	N/A	N/A	N/A	N.L.A.	827509A12	N/A	N/A	N/A	N/A
30 (2 cyl.) 644cc, Manual	BEL 9854537 - 9928507									
30 (2 cyl.) 644cc, Electric	BEL 9854537 - 9928480									
30 (2 cyl.) 644cc	USA 0G380075 - 0G589999	N/A	N/A	N/A	N.L.A.	827509T 7	N/A	N/A	N/A	N/A
30 (2 cyl.) 644cc, Manual	BEL 9928508 - 9973099									
30 (2 cyl.) 644cc, Electric	BEL 9928481 - 9973099									
30 (2 cyl.) 644cc	USA 0G590000 - 0T598999	N/A	N/A	N/A	N/A	827509T 7	N/A	N/A	N/A	N/A
	BEL 9973100 and up									
30 JET	USA 0C159200 - 0G589999	N/A	N/A	339-832757A 4	332- 5772A 7	N/A	N/A	N/A	N/A	N/A
30 JET	USA 0G590000 - 0T178499	N/A	N/A	N/A	N/A	827509T 7	827509A10	N/A	N/A	N/A
35 (350)	1271884 - 1448139	N.L.A.	394- 1130A 1	N.L.A.	N/A	N/A	N/A	N.L.A.	N.L.A.	N.L.A.
35 (35A)	1271884 - 1448139	N.L.A.	394- 1130A 1	N.L.A.	N/A	N/A	N/A	N.L.A.	N.L.A.	N.L.A.
35 (350)	157114 - 2874703	N.L.A.	N.L.A.	398- 2568T 1	N/A	N/A	N/A	N/A	N/A	N/A
35 (2cyl.) with nut style connections	USA 6445653 - 0B110788	N/A	N/A	339-832757A 4	N.L.A.	N/A	N/A	N/A	N/A	N/A
	BEL 9384476 - 9466646									
	CAN 7209608 and up									
35 (2 cyl.) with bullet style connections	USA 6445653 - 0B110788	N/A	N/A	339-832757A 4	339- 7452A21	N/A	N/A	N/A	N/A	N/A
	BEL 9384476 - 9466646									



Model	Serial # Range	Points	Condenser	Ignition Coil	Switch Box or TPM Ass'y	CDM Ass'y	Second CDM Ass'y	Distributor Cap	Rotor	Brush
	CAN 7209608 and up									
35 (2 cyl.)	USA 0B110789 and up BEL 9466647 and up	N/A	N/A	339-832757A 4	339- 7452A21	N/A	N/A	N/A	N/A	N/A
40 (400)(4 cyl.)	1279685 - 1476509	N.L.A.	394- 1130A 1	N.L.A.	N/A	N/A	N/A	N.L.A.	N.L.A.	N.L.A.
40 (402)(2 cyl.)	USA 3336258 - 3859434 AUS 8002335 - 8016689 BEL 3339688 - 9051458 CAN 3340783 - 7032137	N/A	N/A	339-832757A 4	N.L.A.	N/A	N/A	N/A	N/A	N/A
40 (40, 402)(2 cyl.)	USA 3859435 - 5823917 AUS 8016690 - 8070639 BEL 9051459 - 9298955 CAN 7032138 - 7169337	N/A	N/A	339- 5288T 2	332- 4911A 8	N/A	N/A	N/A	N/A	N/A
40 (2 cyl.)	USA 5823918 - 6443973 AUS 8070640 and up BEL 9298956 - 9415101 CAN 7169338 and up	N/A	N/A	339-832757A 4	N.L.A.	N/A	N/A	N/A	N/A	N/A
40 (2 cyl.) 644cc	USA 0G053314 - 0G380074	N/A	N/A	N/A	N.L.A.	827509A12	N/A	N/A	N/A	N/A
40 (2 cyl.) 644cc, Manual	BEL 9854537 - 9928507									
40 (2 cyl.) 644cc, Electric	BEL 9854537 - 9928480									
40 (2 cyl.) 644cc	USA 0G380075 - 0G589999	N/A	N/A	N/A	N.L.A.	827509T 7	N/A	N/A	N/A	N/A
40 (2 cyl.) 644cc, Manual	BEL 9928508 - 9973099									
40 (2 cyl.) 644cc, Electric	BEL 9928481 - 9973099									
40 (2 cyl.) 644cc	USA 0G590000 and up BEL 9973100 and up	N/A	N/A	N/A	N/A	827509T 7	N/A	N/A	N/A	N/A
40 (3 cyl.)	USA 0G531301 - 0T999999 BEL 9973100 and up	N/A	N/A	N/A	N/A	827509T 7(1)	827509A10(2)	N/A	N/A	N/A
40 (Lightning)	0N000001 and up	N/A	N/A	16064006	16061005	N/A	N/A	N/A	N/A	N/A
40XR (Lightning)	0N000513 and up	N/A	N/A	16064006	16061005	N/A	N/A	N/A	N/A	N/A
40 (4 cyl.)	USA 0C159200 and up BEL 9570790 and up	N/A	N/A	339-832757A 4	332- 5772A 7	N/A	N/A	N/A	N/A	N/A
40 JET	USA 0T178500 and up BEL 0P094500 and up	N/A	N/A	N/A	N/A	827509T 7(1)	827509A10(2)	N/A	N/A	N/A
45 (MARK 58,E,AM,AE)(MARK 55AE,AM)	1139538 and up	N.L.A.	394- 1130A 1	N.L.A.	N/A	N/A	N/A	N.L.A.	N.L.A.	N.L.A.
45 (450)(4 cyl.)	1476510 - 1531958	N.L.A.	394- 1130A 1	N.L.A.	N/A	N/A	N/A	N.L.A.	N.L.A.	N.L.A.
45 (4 cyl.)	USA 5531630 and up AUS 8063985 and up BEL 9248006 and up CAN 7143688 and up	N/A	N/A	339-832757A 4	332- 5772A 7	N/A	N/A	N/A	N/A	N/A
45 JET (3 cyl.)	USA 0G290584 - 0G589999 USA 0G590000 - 0G760299	N/A	N/A	339-832757A 4	19052A 8	N/A	N/A	N/A	N/A	N/A
45 JET (3 cyl.)	USA 0G760300 - 0T178499 BEL 0P017000 - 0P094499	N/A	N/A	N/A	N/A	827509T 7(1)	827509A10(2)	N/A	N/A	N/A
50 (500)(4 cyl.)	USA 1421113 - 2305100 CAN 1755549 - 2305100	N.L.A.	394- 1130A 1	N.L.A.	N/A	N/A	N/A	N.L.A.	N.L.A.	N.L.A.
50 (500)(4 cyl.)	2305101 - 2858813	N/A	N/A	N.L.A.	333- 3213A 3	N/A	N/A	N.L.A.	N.L.A.	393- 1293A 1
50 (500E-7-SS)(4 cyl.)	2305101 - 2858813	N/A	N/A	N.L.A.	332- 2986A27	N/A	N/A	N.L.A.	N.L.A.	393- 1293A 1
50 (500)(4 cyl.)	USA 2858814 - 4140999 AUS 2863739 - 8029514 BEL 9001581 - 9082513 CAN 2742142 - 7051982	N/A	N/A	N.L.A.	333- 3213A 3	N/A	N/A	N.L.A.	N.L.A.	N.L.A.
50 (500)(4 cyl.)	USA 4141000 - 4357639 AUS 8029515 - 8030089 BEL 9082514 - 9107213	N/A	N/A	332- 4895T 2	333- 3213A 3	N/A	N/A	N.L.A.	N.L.A.	N.L.A.

**Not all parts listed are available for the European, C.I.S., Africa and Middle East Markets.**  
**For more information, please contact your local Mercury, Mariner, MerCruiser or Quicksilver Office.**

# IGNITION

Model	Serial # Range	Points	Condenser	Ignition Coil	Switch Box or TPM Ass'y	CDM Ass'y	Second CDM Ass'y	Distributor Cap	Rotor	Brush
	CAN 7051983 - 7068997									
50 (50, 500)(4 cyl.)	USA 4357640 - 5193258 AUS 8030090 - 8057394 BEL 9107214 - 9217255 CAN 7068998 - 7116222	N/A	N/A	339- 5288T 2	332- 5772A 7	N/A	N/A	N/A	N/A	N/A
50 (50, 500)(4 cyl.)	USA 5193259 - 5531629 AUS 8057395 - 8063984 BEL 9217256 - 9248005 CAN 7116223 - 7143687	N/A	N/A	339-832757A 4	332- 5772A 7	N/A	N/A	N/A	N/A	N/A
50 (4 cyl.)	USA 5531630 and up AUS 8063985 and up BEL 9248006 and up CAN 7143688 and up	N/A	N/A	339-832757A 4	332- 5772A 7	N/A	N/A	N/A	N/A	N/A
50 (3 cyl.)	USA 6428681 - 0D000749 BEL 9385911 - 9683054 CAN 7208333 and up	N/A	N/A	339-832757A 4	332- 7778A12	N/A	N/A	N/A	N/A	N/A
50 (3 cyl.)	USA 0D000750 - 0G589999 BEL 9683055 - 9973099	N/A	N/A	339-832757A 4	19052A 8	N/A	N/A	N/A	N/A	N/A
50 (3 cyl.)	USA 0G590000 - 0T999999 BEL 9973100 and up	N/A	N/A	N/A	N/A	827509T 7(1)	827509A10(2)	N/A	N/A	N/A
55 (3 cyl.)	USA 0D000750 - 0G589999 BEL 9683055 - 9973099	N/A	N/A	339-832757A 4	19052A 8	N/A	N/A	N/A	N/A	N/A
55 (3 cyl.)	USA 0G590000 - 0G760299 BEL 9973100 - 0P016999	N/A	N/A	N/A	N/A	827509T 7	N/A	N/A	N/A	N/A
55 (3 cyl.)	USA 0G760300 and up BEL 0P017000 and up	N/A	N/A	N/A	N/A	827509T 7(1)	827509A10(2)	N/A	N/A	N/A
60 (MARK 75)	1072997 and up	N.L.A.	N.L.A.	898253T24	N/A	N/A	N/A	N.L.A.	393- 1280A 1	393- 1293A 1(3)
60 (600)(6 cyl.)	1303411 - 1542744	N.L.A.	N/A	898253T24	N/A	N/A	N/A	N.L.A.	393- 1280A 1	393- 1293A 1(3)
60 (3 cyl.)	USA 6428681 - 0D000749 BEL 9385911 - 9683054 CAN 7208333 and up	N/A	N/A	339-832757A 4	332- 7778A12	N/A	N/A	N/A	N/A	N/A
60 (3 cyl.)	USA 0D000750 - 0G589999 BEL 9683055 - 9973099	N/A	N/A	339-832757A 4	19052A 8	N/A	N/A	N/A	N/A	N/A
60 (3 cyl.)	USA 0G590000 - 0G760299 BEL 9973100 - 0P016999	N/A	N/A	N/A	N/A	827509T 7	N/A	N/A	N/A	N/A
60 (3 cyl.)	USA 0G760300 and up BEL 0P017000 and up	N/A	N/A	N/A	N/A	827509T 7(1)	827509A10(2)	N/A	N/A	N/A
65 (650)(4 cyl.)	1542745 - 2309310	N.L.A.	394- 1130A 1	N.L.A.	N/A	N/A	N/A	N.L.A.	N.L.A.	N.L.A.
65 (650)(4 cyl.)	2309311 - 2803561	N/A	N/A	332- 4895A 5	333- 3213A 3	N/A	N/A	N.L.A.	N.L.A.	N.L.A.
65 (650E-5-SS)(4 cyl.)	2309311 - 2803561	N/A	N/A	332- 4895A 5	332- 2986A27	N/A	N/A	N.L.A.	N.L.A.	N.L.A.
65 (650)(4 cyl.)	2803562 - 2874263	N/A	N/A	332- 4895A 5	332- 2986A27	N/A	N/A	N.L.A.	N.L.A.	393- 1293A 1
65 (650)(4 cyl.)	2997339 - 3293183	N/A	N/A	332- 4895A 5	332- 2986A27	N/A	N/A	N.L.A.	N.L.A.	393- 1293A 1
65 (650)(3 cyl.)(With 3 3/8 inch High Coil)	3293184 - 3525440	N/A	N/A	332- 4895T 2	N.L.A.	N/A	N/A	N.L.A.	N.L.A.	393- 1293A 1
65 (650)(3 cyl.)(With 2 7/8 inch High Coil)	3293184 - 3525440	N/A	N/A	N.L.A.	N.L.A.	N/A	N/A	N.L.A.	N.L.A.	393- 1293A 1
65 (650)(3 cyl.)	USA 3547987 - 4382056 AUS 8006640 - 8042349 BEL 9020074 - 9112988 CAN 7013633 - 7073472	N/A	N/A	332- 4895T 2	N.L.A.	N/A	N/A	N.L.A.	N.L.A.	393- 1293A 1
65 (650)(3 cyl.)	USA 4382057 - 4571651 BEL 9112989 - 9135824 CAN 7073473 - 7087822	N/A	N/A	339- 5288T 2	332- 7778A12	N/A	N/A	N/A	N/A	N/A

Model	Serial # Range	Points	Condenser	Ignition Coil	Switch Box or TPM Ass'y	CDM Ass'y	Second CDM Ass'y	Distributor Cap	Rotor	Brush
65 JET	USA 0D283222 - 0G437999	N/A	N/A	339-832757A 4	18495A26	N/A	N/A	N/A	N/A	N/A
	BEL 9793577 - 9926999									
65 JET	USA 0G438000 and up	N/A	N/A	N/A	N/A	827509A10	N/A	N/A	N/A	N/A
	BEL 9927000 and up									
70 (MARK 78,78A)(MARK 75A)	1110600 and up	N.L.A.	N.L.A.	898253T24	N/A	N/A	N/A	N.L.A.	393- 1280A 1	393- 1293A 1(3)
70 (700)(6 cyl.)	1296411 - 1566239	N.L.A.	N.L.A.	898253T24	N/A	N/A	N/A	N.L.A.	393- 1280A 1	393- 1293A 1(3)
70 (3 cyl.)	USA 4571652 - 5128279	N/A	N/A	339- 5288T 2	332- 7778A12	N/A	N/A	N/A	N/A	N/A
	AUS 8042350 - 8056219									
	BEL 9135825 - 9207525									
	CAN 7087823 - 7110997									
70 (3 cyl.)	USA 5128280 and up	N/A	N/A	339-832757A 4	332- 7778A12	N/A	N/A	N/A	N/A	N/A
	AUS 8056220 and up									
	BEL 9207526 and up									
	CAN 7110998 and up									
75 (4 cyl.)	USA 6432901 and up	N/A	N/A	339-832757A 4	332- 5772A 7	N/A	N/A	N/A	N/A	N/A
	BEL 9393856 and up									
	CAN 7208573 and up									
75 (3 cyl.)	USA 0C222000 - 0D283221	N/A	N/A	339-832757A 4	332- 7778A12	N/A	N/A	N/A	N/A	N/A
	BEL 9589039 - 9793576									
75 (3 cyl.)	USA 0D283222 - 0G437999	N/A	N/A	339-832757A 4	18495A26	N/A	N/A	N/A	N/A	N/A
	BEL 9793577 - 9926999									
75 (3 cyl.)	USA 0G438000 and up	N/A	N/A	N/A	N/A	827509A10	N/A	N/A	N/A	N/A
	BEL 9927000 and up									
75 (3 cyl) Optimax	USA 0T801000 and up	N/A	N/A	339-8M0077471	N/A	N/A	N/A	N/A	N/A	N/A
80 (800)(6 cyl.)	1335465 - 1566239	N.L.A.	N.L.A.	898253T24	N/A	N/A	N/A	N.L.A.	393- 1280A 1	393- 1293A 1(3)
80 (800)(4 cyl.)	2559001 - 3493912	N/A	N/A	332- 4895A 5	332- 2986A27	N/A	N/A	N.L.A.	N.L.A.	393- 1293A 1
80 (80, 800)(4 cyl.)	USA 483199 - 5141096	N/A	N/A	339- 5288T 2	332- 5772A 7	N/A	N/A	N/A	N/A	N/A
	AUS 8050200 - 8056519									
	BEL 9177626 - 9207925									
	CAN 7110998 - 7122587									
80 (4 cyl.)	USA 5141097 - 6432900	N/A	N/A	339-832757A 4	332- 5772A 7	N/A	N/A	N/A	N/A	N/A
	AUS 8056520 and up									
	BEL 9207926 - 9393855									
	CAN 7122588 - 7208572									
80 (3 cyl.)	USA 0A996142 and up	N/A	N/A	339-832757A 4	332- 7778A12	N/A	N/A	N/A	N/A	N/A
	BEL 9483121 and up									
80 JET	USA 0D283222 - 0G437999	N/A	N/A	339-832757A 4	332- 5772A 7	N/A	N/A	N/A	N/A	N/A
	BEL 9793577 - 9926999									
80 JET	USA 0G438000 and up	N/A	N/A	N/A	N/A	827509A10	N/A	N/A	N/A	N/A
	BEL 9927000 and up									
85 (850)(6 cyl.)	1460999 - 1766823	N.L.A.	N.L.A.	898253T24	N/A	N/A	N/A	N.L.A.	393- 1280A 1	393- 1293A 1(3)
85 (850)(4 cyl.)	USA 3493913 - 3865694	N/A	N/A	332- 4895A 5	332- 2986A27	N/A	N/A	N.L.A.	N.L.A.	393- 1293A 1
	AUS 8005440 - 8017139									
	BEL 9011604 - 9053363									
	CAN 7010108 - 7033027									
85 (850)(4 cyl.)	USA 3865695 - 4366801	N/A	N/A	332- 4895T 2	332- 2986A27	N/A	N/A	N.L.A.	N.L.A.	393- 1293A 1
	AUS 8017140 - 8043774									
	BEL 9053364 - 9110013									
	CAN 7033028 - 7071372									
85 (850)(4 cyl.)	USA 4366802 - 4831998	N/A	N/A	339- 5288T 2	332- 5772A 7	N/A	N/A	N/A	N/A	N/A
	AUS 8043775 - 8050199									
	BEL 9110014 - 9177625									
	CAN 7071373 - 7110997									

**Not all parts listed are available for the European, C.I.S., Africa and Middle East Markets.**  
**For more information, please contact your local Mercury, Mariner, MerCruiser or Quicksilver Office.**

# IGNITION

Model	Serial # Range	Points	Condenser	Ignition Coil	Switch Box or TPM Ass'y	CDM Ass'y	Second CDM Ass'y	Distributor Cap	Rotor	Brush
90 (900)(6 cyl.)	1766824 - 1869775	N.L.A.	N.L.A.	898253T24	N/A	N/A	N/A	N.L.A.	393- 1280A 1	393- 1293A 1(3)
90 (90, 900)(6 cyl.)	USA 4845301 - 5299505 CAN 7111698 - 7123762	N/A	N/A	332- 4895T 2	332- 2986A21	N/A	N/A	N.L.A.	N.L.A.	393- 1293A 1
90 (6 cyl.)	USA 5299506 and up AUS 8060545 and up CAN 7147088 and up	N/A	N/A	339-832757A 4	332- 7778A12	N/A	N/A	N/A	N/A	N/A
90 (3 cyl.)	USA 0A996142 - 0D283221 BEL 9483121 - 9793576	N/A	N/A	339-832757A 4	332- 7778A12	N/A	N/A	N/A	N/A	N/A
90 (3 cyl.)	USA 0D283222 - 0G437999 BEL 9793577 - 9926999	N/A	N/A	339-832757A 4	18495A26	N/A	N/A	N/A	N/A	N/A
90 (3 cyl.)	USA 0G438000 and up BEL 9927000 and up	N/A	N/A	N/A	N/A	827509A10	N/A	N/A	N/A	N/A
90 (3 cyl) Optimax	USA 0T801000 and up	N/A	N/A	339-8M0077471	N/A	N/A	N/A	N/A	N/A	N/A
95 (950)(6 cyl.)	1869776 - 2318585	N.L.A.	N.L.A.	898253T24	N/A	N/A	N/A	N.L.A.	393- 1280A 1	393- 1293A 1(3)
100 (1000)(6 cyl.)	1464949 - 2318585	N.L.A.	N.L.A.	898253T24	N/A	N/A	N/A	N.L.A.	393- 1280A 1	393- 1293A 1(3)
100 (1000)(6 cyl.)	2318586 - 2836018	N/A	N/A	332- 4895A 5	332- 2986A21	N/A	N/A	N.L.A.	N.L.A.	393- 1293A 1
100 (1000BP)(6 cyl.)	2399698 - 2641854	N/A	N/A	332- 4895A 5	N.L.A.	N/A	N/A	N.L.A.	N.L.A.	393- 1293A 1
100 (1000BP)(6 cyl.)	2641855 - 3253111	N/A	N/A	332- 4895A 5	N.L.A.	N/A	N/A	N.L.A.	N.L.A.	393- 1293A 1
100 (4 cyl.)	USA 0B209468 - 0G437999 BEL 9523034 - 9926999	N/A	N/A	339-832757A 4	332- 5772A 7	N/A	N/A	N/A	N/A	N/A
100 (4 cyl.)	USA 0G438000 and up BEL 9927000 and up	N/A	N/A	N/A	N/A	827509A10	N/A	N/A	N/A	N/A
110 (1100)(6 cyl.)	1870204 - 2314955	N.L.A.	N.L.A.	898253T24	N/A	N/A	N/A	N.L.A.	393- 1280A 1	393- 1293A 1(3)
115 (1150)(6 cyl.)	USA 2836019 - 2928720	N/A	N/A	332- 4895A 5	332- 2986A21	N/A	N/A	N.L.A.	N.L.A.	393- 1293A 1
115 (1150)(6 cyl.)	USA 2928721 - 4112634 AUS 8008865 - 8027114 CAN 7010763 - 7047257	N/A	N/A	332- 4895A 5	332- 2986A21	N/A	N/A	N.L.A.	N.L.A.	393- 1293A 1
115 (115, 1150)(6 cyl.)	USA 4112635 - 5314655 AUS 8027115 - 8061119 CAN 7047258 - 7131212	N/A	N/A	332- 4895T 2	332- 2986A21	N/A	N/A	N.L.A.	N.L.A.	393- 1293A 1
115 (6 cyl.)	USA 5314656 and up AUS 8061120 and up CAN 7131213 and up	N/A	N/A	339-832757A 4	332- 7778A12	N/A	N/A	N/A	N/A	N/A
115 (4 cyl.)	USA 0B209468 - 0G437999 BEL 9523034 - 9926999	N/A	N/A	339-832757A 4	332- 5772A 7	N/A	N/A	N/A	N/A	N/A
115 (4 cyl.)	USA 0G438000 and up BEL 9927000 and up	N/A	N/A	N/A	N/A	827509A10	N/A	N/A	N/A	N/A
115 (3 cyl) Optimax	USA 0T801000 and up	N/A	N/A	339-8M0077471	N/A	N/A	N/A	N/A	N/A	N/A
115 (3 cyl.) Pro XS	USA 1B751825 and up	N/A	N/A	339-8M0077471	N/A	N/A	N/A	N/A	N/A	N/A
125 (1250)(6 cyl.)	2314956 - 2839368	N/A	N/A	332- 4895A 5	332- 2986A21	N/A	N/A	N.L.A.	N.L.A.	393- 1293A 1
125 (1250BP)(6 cyl.)	2400058 - 2641854	N/A	N/A	332- 4895A 5	N.L.A.	N/A	N/A	N.L.A.	N.L.A.	393- 1293A 1
125 (1250BP)(6 cyl.)	2641855 - 3253111	N/A	N/A	332- 4895A 5	N.L.A.	N/A	N/A	N.L.A.	N.L.A.	393- 1293A 1
125 (4 cyl.)	USA 0D283222 - 0G437999 BEL 9793577 - 9926999	N/A	N/A	339-832757A 4	332- 5772A 7	N/A	N/A	N/A	N/A	N/A
125 (4 cyl.)	USA 0G438000 and up BEL 9927000 and up	N/A	N/A	N/A	N/A	827509A10	N/A	N/A	N/A	N/A
125 (3 cyl.) Optimax	USA 1B736885 and up	N/A	N/A	339-8M0077471	N/A	N/A	N/A	N/A	N/A	N/A
135 (1350)(6 cyl.)	2839369 - 2940020	N/A	N/A	332- 4895A 5	332- 2986A21	N/A	N/A	N.L.A.	N.L.A.	393- 1293A 1
135 (1350)(6 cyl.)	2940021 - 3293233	N/A	N/A	332- 4895A 5	332- 2986A21	N/A	N/A	N.L.A.	N.L.A.	393- 1293A 1
140 (1400)(6 cyl.)	3293234 - 3502805	N/A	N/A	332- 4895A 5	332- 2986A21	N/A	N/A	N.L.A.	N.L.A.	393- 1293A 1
140 (140, 1400)(6 cyl.)	USA 4865678 - 5327662 AUS 8052650 - 8052879 CAN 7112773 - 7132512	N/A	N/A	332- 4895T 2	332- 2986A21	N/A	N/A	N.L.A.	N.L.A.	393- 1293A 1
140 (6 cyl.)	USA 5327663 and up	N/A	N/A	339-832757A 4	332- 7778A12	N/A	N/A	N/A	N/A	N/A

Model	Serial # Range	Points	Condenser	Ignition Coil	Switch Box or TPM Ass'y	CDM Ass'y	Second CDM Ass'y	Distributor Cap	Rotor	Brush
150 (1500)(6 cyl.)	AUS 8066065 and up									
	CAN 7132513 and up									
	USA 3502806 - 4121434	N/A	N/A	332- 4895A 5	332- 2986A21	N/A	N/A	N.L.A.	N.L.A.	393- 1293A 1
	AUS 8005615 - 8028039									
150 (1500)(6 cyl.)	CAN 7010533 - 7048782									
	USA 4121435 - 4865677	N/A	N/A	332- 4895T 2	332- 2986A21	N/A	N/A	N.L.A.	N.L.A.	393- 1293A 1
	AUS 8028040 - 8052649									
	CAN 7048783 - 7112772									
150 (1500XS)(6 cyl.)	USA 4868648 - 5327662	N/A	N/A	332- 4895T 2	N.L.A.	N/A	N/A	N.L.A.	N.L.A.	393- 1293A 1
V-105 JET	USA 0D082000 and up	N/A	N/A	339-832757A 4	332- 7778A12	N/A	N/A	N/A	N/A	N/A
V-135	USA 0A904646 - 0G960499	N/A	N/A	339-832757A 4	332- 7778A12	N/A	N/A	N/A	N/A	N/A
V-135	USA 0G960500 - 0T178499	N/A	N/A	N/A	N/A	827509T 7	N/A	N/A	N/A	N/A
V-135 DFI	USA 0G590000 - 1B490865	N/A	N/A	339-856991A 1	N/A	N/A	N/A	N/A	N/A	N/A
V-135 DFI	USA 1B490866 and up	N/A	N/A	339-8M0077473	N/A	N/A	N/A	N/A	N/A	N/A
V-140 JET	USA 0D082000 - 0T178499	N/A	N/A	339-832757A 4	332- 7778A12	N/A	N/A	N/A	N/A	N/A
V-150 (150, 1500) w/orange coils	USA 4868998 - 0A904645	N/A	N/A	339- 5288T 2	332- 7778A12	N/A	N/A	N/A	N/A	N/A
V-150 (150, 1500) w/navy blue coils	USA 4868998 - 0A904645	N/A	N/A	339-832757A 4	332- 7778A12	N/A	N/A	N/A	N/A	N/A
V-150	USA 0A904646 - 0G960499	N/A	N/A	339-832757A 4	332- 7778A12	N/A	N/A	N/A	N/A	N/A
V-150	USA 0G960500 and up	N/A	N/A	N/A	N/A	827509T 7	N/A	N/A	N/A	N/A
V-150 EFI	USA 0D082000 - 0G960499	N/A	N/A	339-832757A 4	332- 7778A12	N/A	N/A	N/A	N/A	N/A
V-150 EFI	USA 0G960500 - 0T408999	N/A	N/A	N/A	N/A	827509T 7	N/A	N/A	N/A	N/A
V-150 EFI	USA 0T409000 and up	N/A	N/A	339-8M0077471	N/A	N/A	N/A	N/A	N/A	N/A
V-150 DFI	USA 0G590000 - 1B490865	N/A	N/A	339-856991A 1	N/A	N/A	N/A	N/A	N/A	N/A
V-150 DFI	USA 1B490866 and up	N/A	N/A	339-8M0077473	N/A	N/A	N/A	N/A	N/A	N/A
V-150 ProXS	USA 1B690542 and up	N/A	N/A	339-8M0077473	N/A	N/A	N/A	N/A	N/A	N/A
V-175 (175, 1750)	USA 4301235 - 5180108	N/A	N/A	339- 5288T 2	332- 7778A12	N/A	N/A	N/A	N/A	N/A
V-175 (175, 1750)	USA 5180109 - 0G960499	N/A	N/A	339-832757A 4	332- 7778A12	N/A	N/A	N/A	N/A	N/A
V-175 EFI	AUS 8064250 and up									
	USA 0D000750 - 0G960499	N/A	N/A	339-832757A 4	332- 7778A12	N/A	N/A	N/A	N/A	N/A
	USA 0G960500 - 0T408999	N/A	N/A	N/A	N/A	827509T 7	N/A	N/A	N/A	N/A
	USA 0T409000 - 0T800999	N/A	N/A	339-8M0077471	N/A	N/A	N/A	N/A	N/A	N/A
V-175 DFI	USA 0T178500 - 1B490865	N/A	N/A	339-856991A 1	N/A	N/A	N/A	N/A	N/A	N/A
V-175 DFI	USA 1B490866 and up	N/A	N/A	339-8M0077473	N/A	N/A	N/A	N/A	N/A	N/A
V-175 Pro XS	USA 1B516339 and up	N/A	N/A	339-8M0077471	N/A	N/A	N/A	N/A	N/A	N/A
V-200 (200, 2000) w/orange coils	USA 4839034 - 5363917	N/A	N/A	339- 5288T 2	332- 7778A12	N/A	N/A	N/A	N/A	N/A
V-200 (200, 2000) w/navy blue coils	USA 4839034 - 5363917	N/A	N/A	339-832757A 4	332- 7778A12	N/A	N/A	N/A	N/A	N/A
V-200	USA 5363918 - 0G960499	N/A	N/A	339-832757A 4	332- 7778A12	N/A	N/A	N/A	N/A	N/A
	AUS 8061595 and up									
V-200	USA 0G960500 and up	N/A	N/A	N/A	N/A	827509T 7	N/A	N/A	N/A	N/A
V-200 EFI	USA 0C100861 - 0G960499	N/A	N/A	339-832757A 4	332- 7778A12	N/A	N/A	N/A	N/A	N/A
V-200 EFI	USA 0G303046 - 0T408999	N/A	N/A	N/A	N/A	827509T 7	N/A	N/A	N/A	N/A
V-200 EFI (2.5L)	USA 0T409000 and up	N/A	N/A	339-8M0077471	N/A	N/A	N/A	N/A	N/A	N/A
V-200 EFI (3.0L)	USA 0T750164 and up	N/A	N/A	339-8M0077471	N/A	N/A	N/A	N/A	N/A	N/A
V-200 DFI	USA 0G386496 - 0G589999	N/A	N/A	N.L.A.	N/A	N/A	N/A	N/A	N/A	N/A
V-200 DFI	USA 0G590000 - 1B504988	N/A	N/A	339-856991A 1	N/A	N/A	N/A	N/A	N/A	N/A
V-200 DFI	USA 1B504989 and up	N/A	N/A	339-8M0077473	N/A	N/A	N/A	N/A	N/A	N/A
V-200 Pro XS	USA 1B504989 and up	N/A	N/A	339-8M0077473	N/A	N/A	N/A	N/A	N/A	N/A
V-220 EFI	USA 0B117316 and up	N/A	N/A	339-832757A 4	332- 7778A12	N/A	N/A	N/A	N/A	N/A
V-225 (2.4L)	USA 5628028 and up	N/A	N/A	339-832757A 4	332- 7778A12	N/A	N/A	N/A	N/A	N/A
V-225 (3.0L)	USA 0D280813 - 0G303045	N/A	N/A	N/A	N/A	827509A12	N/A	N/A	N/A	N/A

**Not all parts listed are available for the European, C.I.S., Africa and Middle East Markets.**  
**For more information, please contact your local Mercury, Mariner, MerCruiser or Quicksilver Office.**

# IGNITION

Model	Serial # Range	Points	Condenser	Ignition Coil	Switch Box or TPM Ass'y	CDM Ass'y	Second CDM Ass'y	Distributor Cap	Rotor	Brush
V-225 (3.0L)	USA 0G303046 - 0T408999	N/A	N/A	N/A	N/A	827509T 7	N/A	N/A	N/A	N/A
V-225 (3.0L) Sea Pro/ Marathon	USA 0G245605 - 0G303045	N/A	N/A	N/A	N/A	827509A12	N/A	N/A	N/A	N/A
V-225 (3.0L) Sea Pro/ Marathon	USA 0G303046 - 0T408999	N/A	N/A	N/A	N/A	827509T 7	N/A	N/A	N/A	N/A
V-225 EFI (3.0L)	USA 0G129222 - 0G303045	N/A	N/A	N/A	N/A	827509A12	N/A	N/A	N/A	N/A
V-225 EFI (3.0L)	USA 0G303046 - 0T408999	N/A	N/A	N/A	N/A	827509T 7	N/A	N/A	N/A	N/A
V-225 EFI (3.0L)	USA 0T409000 and up	N/A	N/A	339-8M0077471	N/A	N/A	N/A	N/A	N/A	N/A
V-225 DFI	USA 0G590000 - 1B504988	N/A	N/A	339-856991A 1	N/A	N/A	N/A	N/A	N/A	N/A
V-225 DFI	USA 1B504989 and up	N/A	N/A	339-8M0077473	N/A	N/A	N/A	N/A	N/A	N/A
V-225 Pro XS	USA 1B104549 - 1B426560	N/A	N/A	339-856991A 1	N/A	N/A	N/A	N/A	N/A	N/A
V-225 Pro XS	USA 1B426561 and up	N/A	N/A	339-8M0077471	N/A	N/A	N/A	N/A	N/A	N/A
V-250 EFI (3.0L)	USA 0G129222 - 0T408999	N/A	N/A	N/A	N/A	827509T 7	N/A	N/A	N/A	N/A
V-250 EFI (3.0L)	USA 0T409000 and up	N/A	N/A	339-8M0077471	N/A	N/A	N/A	N/A	N/A	N/A
V-250 (3.4L)	USA 0C101891 and up	N/A	N/A	339-832757A 4	332- 7778A12	N/A	N/A	N/A	N/A	N/A
V-250 DFI	USA 1B528615 and up	N/A	N/A	339-8M0077471	N/A	N/A	N/A	N/A	N/A	N/A
V-250 Pro XS	USA 1B426561 and up	N/A	N/A	339-8M0077471	N/A	N/A	N/A	N/A	N/A	N/A
V-275 (3.4L)	USA 0C101891 and up	N/A	N/A	339-832757A 4	332- 7778A12	N/A	N/A	N/A	N/A	N/A
V-300 XS	USA 1E001867 and up	N/A	N/A	339-8M0077471	N/A	N/A	N/A	N/A	N/A	N/A
V-300 (3.4L)	USA 5611648 and up	N/A	N/A	339-832757A 4	332- 7778A12	N/A	N/A	N/A	N/A	N/A

(1) 5 inch lead

(2) 9 inch lead

(3) Bottom Brush

(4) N.L.A. from Mercury, order from Land-N-Sea.

## ELECTRICAL SYSTEM

## RECTIFIER

## RECTIFIER



8M0058226

Supersedes the 816770T

## VOLTAGE REGULATORS

## VOLTAGE REGULATOR



815279A 2

Kit replaces original louvered regulator 12082A 1.

## VOLTAGE REGULATOR



8M0084173

## VOLTAGE REGULATOR



18736A21

## VOLTAGE REGULATOR

Image not  
Available.

8M0088351

## BATTERY CABLES

## BATTERY CABLE KIT



84- 88439A50

Pair of 12 ft.(3.7 m) cables, 1 red (+) Positive and 1 black (-) Negative, 4 gauge with ring terminals. This is an optional accessory kit and may not reflect the original cables on your engine. For original manufactured service part replacement, the Electronic Parts Catalog should always be used for each specific engine. For alternate length cables, consult the appropriate service manual.

Fits Mercury/Mariner 75-V6 outboards and the new Verado.

## BATTERY CABLE-POS



84- 88439A25

Single 12 ft. positive cable.

## BATTERY CABLE-NEG



84- 88439A26

Single 12 ft. negative cable.

# ELECTRICAL SYSTEM

## WIRING HARNESS

### WIRING HARNESS



84-822253T20

## STATOR

### IGNITION CHARGING COIL



8M0056334

Located under the flywheel, provides the stator charge to the ignition coil. F4/5/6 hp. FourStroke outboards, JPN-0R067090 and above.

### IGNITION CHARGING COIL



803844T

Located under the flywheel, provides the stator charge to the ignition coil. Fits the F4/5/6 hp. FourStroke outboards, JPN-0R000001-0R067089, BEL-0P073456-0P400999.

### IGNITION CHARGING COIL



803844T01

Located under the flywheel, provides the stator charge to the ignition coil. 8/9.9 hp. FourStroke outboards, beginning with Model Year 2005.

### IGNITION STATOR ASSEMBLY



86617A20

### IGNITION STATOR ASSEMBLY



855721T 8

### IGNITION STATOR ASSEMBLY



86617A17

### IGNITION STATOR ASSEMBLY



398-852386T 8

### IGNITION STATOR ASSEMBLY



398-852387T 9



**IGNITION STATOR ASSEMBLY**



398- 5255

**IGNITION STATOR KIT**

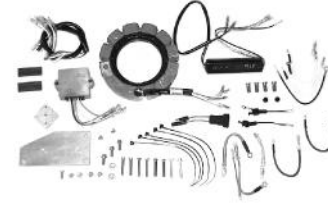

398-832075A15

**IGNITION STATOR ASSEMBLY**



86704A10

**IGNITION STATOR KIT**



398-832075A21

**IGNITION STATOR ASSEMBLY**



398- 5704A 7

**IGNITION STATOR KIT**



835399T

**IGNITION STATOR KIT**



398-832075A20

**IGNITION STATOR KIT**



398-804262T

**IGNITION STATOR KIT**



398-832075A 9

**IGNITION STATOR KIT**

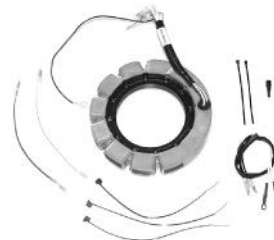

398-832074A11

Not all parts listed are available for the European, C.I.S., Africa and Middle East Markets.  
 For more information, please contact your local Mercury, Mariner, MerCruiser or Quicksilver Office.

**ELECTRICAL SYSTEM**

**IGNITION STATOR KIT**



398-832074A 6

**IGNITION STATOR KIT**



398-832075A 5

**IGNITION STATOR KIT**



398-825089 1

**IGNITION STATOR KIT**



398-832075A 7

**IGNITION STATOR KIT**



76314A 3

**IGNITION STATOR KIT**

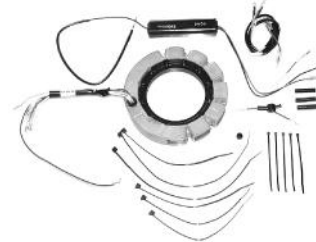

398-832074A 4

**IGNITION STATOR KIT**

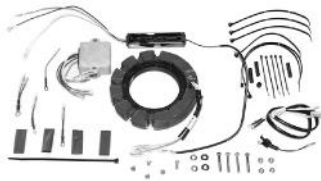

398-9873A38

**IGNITION STATOR KIT**



398-832075A 6

**IGNITION STATOR KIT**



398-832075A19

**IGNITION STATOR KIT**



398-832075A 8

**IGNITION STATOR ASSEMBLY**



**398- 5454A26**

**IGNITION STATOR ASSEMBLY**



**398- 4793**

**IGNITION STATOR ASSEMBLY**



**398-852386T 6**

**IGNITION STATOR ASSEMBLY**



**398- 5454A17**

**IGNITION STATOR ASSEMBLY**



**398-852387T 7**

**IGNITION STATOR ASSEMBLY**



**398- 9610A19**

**IGNITION STATOR ASSEMBLY**



**398-852386T 8**

**IGNITION STATOR ASSEMBLY**



**398- 5454A35**

**IGNITION STATOR ASSEMBLY**



**398-852387T 9**

**IGNITION STATOR ASSEMBLY**



**398- 9610A 5**

Not all parts listed are available for the European, C.I.S., Africa and Middle East Markets.  
For more information, please contact your local Mercury, Mariner, MerCruiser or Quicksilver Office.

**ELECTRICAL SYSTEM**

**IGNITION STATOR ASSEMBLY**



398- 9873A 4

**IGNITION STATOR ASSEMBLY**



398- 5454A55

**IGNITION STATOR ASSEMBLY**



398- 5454A 7

**IGNITION STATOR ASSEMBLY**



398-878143T05

**IGNITION STATOR ASSEMBLY**



398- 5454A32

**IGNITION STATOR ASSEMBLY**



398-881336T 2

**IGNITION STATOR KIT**



398-821935A 3

**IGNITION STATOR ASSEMBLY**



398-858404T 4

**IGNITION STATOR KIT**



398-821935A 5

**IGNITION STATOR ASSEMBLY**



898101T01

## STATOR

Image not  
Available.**300-8M0088059**

Fits the F75-115 (2.1L) FourStroke outboard beginning with serial number USA 2B095049 and up.

## STATOR APPLICATION CHART - MERCURY/MARINER

## Mercury/Mariner Ignition Stators

Model	Model Note		Serial # Range	Standard Stator	OPTIONAL Stator CONVERTS 9 AMP TO 16 AMP
2.5 FourStroke		JPN	0R131842 and up	N/A	N/A
3.5 FourStroke		JPN	0R131842 and up	N/A	N/A
4 FourStroke	Ignition Charging Coil	JPN	0R000001 - 0R067089	803844T	N/A
		BEL	0P073456 - 0P400999		
4 FourStroke	Ignition Charging Coil	JPN	0R067090 and up	8M0056334	N/A
		BEL	0P401000 and up		
5 FourStroke	Ignition Charging Coil	JPN	0R000001 - 0R067089	803844T	N/A
		BEL	0P073456 - 0P400999		
5 FourStroke	Ignition Charging Coil	JPN	0R067090 and up	8M0056334	N/A
		BEL	0P401000 and up		
6 FourStroke	Ignition Charging Coil	JPN	0R000001 - 0R067089	803844T	N/A
		BEL	0P073456 - 0P400999		
6 FourStroke	Ignition Charging Coil	JPN	0R067090 and up	8M0056334	N/A
		BEL	0P401000 and up		
6		USA	0A197112 - 0G760299	86617A20	N/A
		BEL	9461526 - 0P016999		
6		USA	0G760300 - 0T800749	855721T 8	N/A
		BEL	0P017000 and up		
7.5 (75)			2810637 - 3274632	N.L.A.	N/A
7.5 (7.5, 75)		USA	3801458 and up	N.L.A.	N/A
		AUS	8015315 and up		
		BEL	9068874 and up		
		CAN	7043133 and up		
8		USA	0A197112 - 0G760299	86617A20	N/A
		BEL	9461526 - 0P016999		
8		USA	0G760300 and up	855721T 8	N/A
		BEL	0P017000 and up		
8 FourStroke, Manual Models	232cc	USA	0H000058 - 0H017349	N.L.A.	N/A
8 FourStroke, Manual Models	232cc	USA	0G760300 - 0T178499	N.L.A.	N/A
8 FourStroke	323cc with capacitor charging coil.	BEL	0P086824 - 0P325499	835399T	N/A
8 FourStroke	209cc, Ignition Charging Coil	JPN	0R042475 and up	803844T01	N/A
		BEL	0P325500 and up		
9.8 (110)			2798057 - 3263262	N.L.A.	N/A
9.8 (9.8, 110)		USA	3795658 and up	N.L.A.	N/A
		AUS	8015040 and up		
		BEL	9041439 and up		
		CAN	7027323 and up		
9.9		USA	0A197112 - 0G760299	86617A20	N/A
		BEL	9461526 - 0P016999		
9.9		USA	0G760300 and up	855721T 8	N/A
		BEL	0P017000 and up		
9.9 FourStroke (Manual Models)	232cc	USA	0H000058 - 0H016909	N.L.A.	N/A

Not all parts listed are available for the European, C.I.S., Africa and Middle East Markets.  
For more information, please contact your local Mercury, Mariner, MerCruiser or Quicksilver Office.

# ELECTRICAL SYSTEM

Model	Model Note		Serial # Range	Standard Stator	OPTIONAL Stator CONVERTS 9 AMP TO 16 AMP
9.9 FourStroke (Manual Models)	323cc with capacitor charging coil.	USA	0G760300 - 1B226999	835399T	N/A
9.9 FourStroke (Electric Models)	232cc	USA	0H000058 - 0H016909	N.L.A.	N/A
9.9 FourStroke (Electric Models)	323cc with capacitor charging coil.	USA	0G760300 - 0T979999	835399T	N/A
		BEL	0P075166 - 0P400999		
9.9 FourStroke	Ignition Charging Coil	JPN	0R042475 and up	803844T01	N/A
		BEL	0P325500 and up		
15		USA	0B292414 - 0G760299	86617A20	N/A
		BEL	9542620 - 0P016999		
15		USA	0G760300 and up	855721T 8	N/A
		BEL	0P017000 and up		
15 FourStroke (Manual Models)	323cc with capacitor charging coil.	USA	0G590000 - 1B727495	835399T	N/A
15 FourStroke (Electric Models)	323cc with capacitor charging coil.	USA	0G590000 - 1B727495	835399T	N/A
15 FourStroke	351cc	JPN	0R235949 and up	879147T69	N/A
18 (18, 18XD)		USA	5837437 and up	86617A20	N/A
		AUS	8071973 and up		
		BEL	9308306 and up		
		CAN	7173723 and up		
20 (200)			2827677 - 3226957	N.L.A.	N/A
20 (20, 200)		USA	4403783 - 6443972	N.L.A.	N/A
		AUS	8039075 and up		
		BEL	9122765 - 9415100		
		CAN	7077248 - 7209532		
20 (20, 20XD)		USA	6443973 - 0G044026	86617A20	N/A
		BEL	9415101 - 9807908		
		CAN	7209533 and up		
20		USA	0G044027 - 0G437999	86617A17	N/A
		BEL	9807909 - 9926999		
20		USA	0G438000 - 0G760299	86617A20	N/A
		BEL	9972700 - 0P016999		
20		USA	0G760300 - 0T800999	855721T 8	N/A
		BEL	0P017000 and up		
20 FourStroke		JPN	0R235168 and up	879147T69	N/A
20 JET		USA	0G044027 - 0G437999	86617A17	N/A
		BEL	9807909 - 9926999		
20 JET		USA	0G438000 - 0G760299	86617A20	N/A
		BEL	9972700 - 0P016999		
20 JET		USA	0G760300 and up	855721T 8	N/A
		BEL	0P017000 and up		
25 (25, 25XD)		USA	5705532 - 0G044026	86617A20	N/A
		AUS	8073158 and up		
		BEL	9315316 - 9807908		
		CAN	7166928 and up		
25 (2 cyl)		USA	0G044027 - 0G437999	86617A17	N/A
		BEL	9807909 - 9926999		
25 (2 cyl)		USA	0G438000 - 0G760299	86617A20	N/A
		BEL	9972700 - 0P016999		
25 (2 cyl)		USA	0G760300 and up	855721T 8	N/A
		BEL	0P017000 and up		
25 FourStroke	Manual Models	USA	0G590000 - 0G960499	398-852386T 8	N/A
		BEL	9973100 - 0P058999		
25 FourStroke	Electric Models	USA	0G590000 - 0G960499	398-852387T 9	N/A
		BEL	9973100 - 0P058999		

Model	Model Note		Serial # Range	Standard Stator	OPTIONAL Stator CONVERTS 9 AMP TO 16 AMP
25 FourStroke, Carb Models	Manual start	USA	0G960500 - 1B344298	398-852386T 6	N/A
		BEL	0P059000 - 0P388282		
25 FourStroke, Carb Models	Electric start	USA	0G960500 - 1B344298	398-852387T 7	N/A
		BEL	0P059000 - 0P388282		
25 FourStroke	EFI	JPN	0R016999 and up	898101T01	N/A
25 JET, FourStroke	EFI	JPN	0R165086 and up	898101T01	N/A
30 JET (4 cyl)(Electric Models)		USA	0C159200 - 0D055047	398-832075A20	N/A
		BEL	9570790 - 9665164		
30 JET (4 cyl)(Electric Models)	With stator stamped 818535A3 or A13	USA	0D055048 - 0G589999	398-832075A20	N/A
30 JET (4 cyl)(Electric Models)	With Voltage Regulator	USA	0D055048 - 0G589999	398-832075A 9	N/A
30 JET (4 cyl)(Electric Models)	Without Voltage Regulator	USA	0D055048 - 0G589999	398-832075A20	398-832075A15
30 JET (3 cyl)(Electric Models)		USA	0G590000 - 0T408999	398-832075A21	N/A
30 (2 cyl)(644cc)	Manual Models	USA	0G053314 and up	398-832074A11	N/A
30 (2 cyl)(644cc)	Electric Models	USA	0G053314 and up	398-832075A21	N/A
30 (4-Stroke)(3 cyl) Carb	Manual Models	USA	0G760300 - 0G960499	398-852386T 8	N/A
30 (4-Stroke)(3 cyl) Carb	Electric Models	USA	0G760300 - 0G960499	398-852387T 9	N/A
30 (4-Stroke)(3 cyl) Carb	Manual Models	USA	0G960500 - 1B226999	398-852386T 6	N/A
		BEL	0P153500 - 0P400999		
30 (4-Stroke)(3 cyl) Carb	Electric Models	USA	0G960500 - 1B226999	398-852387T 7	N/A
		BEL	0P153500 - 0P400999		
30 FourStroke (3 cyl)	EFI	USA	0G409000 - 1B226999	398-878143T05	N/A
		BEL	0P153500 - 0P400999		
30 FourStroke	EFI	JPN	0R016999 and up	898101T01	N/A
35 (2 cyl)		USA	6445653 - 0B110788	86617A20	N/A
		BEL	9384476 and up		
		CAN	7209608 and up		
40 (40, 402)(2 cyl)(Electric Models)		USA	3859435 - 5823917	398- 5255	N/A
		AUS	8016690 - 8070639		
		BEL	9051459 - 9298955		
		CAN	7032138 - 7169337		
40 (2 cyl)(Electric Models)		USA	5823918 - 0G053313	86704A10	N/A
		AUS	8070640 and up		
		BEL	9298956 and up		
		CAN	7169338 and up		
40 (2 cyl)(644cc)	Manual Models	USA	0G053314 and up	398-832074A11	N/A
40 (2 cyl)(644cc)	Electric Models	USA	0G053314 and up	398-832075A21	N/A
40 (3 cyl)	Electric Models	USA	0G590000 - 0T999999	398-832075A21	N/A
		BEL	0P017000 - 0P325499		
40 (3 cyl)	Manual Models	USA	0G590000 - 0T999999	398-832074A11	N/A
		BEL	0P017000 - 0P325499		
40 (4 cyl)	Manual Models	USA	0C159200 and up	398-832074A 6	N/A
		BEL	9570790 and up		
40 (4 cyl)	Electric Models	USA	0C159200 - 0D055047	398-832075A20	N/A
		BEL	9570790 - 9665164		
40 (4 cyl)(Electric Models)	With stator stamped 818535A3 or A13	USA	0D055048 and up	398-832075A20	N/A
		BEL	9665165 and up		
40 (4 cyl)(Electric Models)	With Voltage Regulator	USA	0D055048 and up	398-832075A 9	N/A
		BEL	9665165 and up		
40 (4 cyl)(Electric Models)	Without Voltage Regulator	USA	0D055048 and up	398-832075A20	398-832075A15
		BEL	9665165 and up		
40 FourStroke (3 cyl) Carb	Manual Models	USA	0G760300 - 0G960499	398-852386T 8	N/A
40 FourStroke (3 cyl) Carb	Electrical Models	USA	0G760300 - 0G960499	398-852387T 9	N/A
40 FourStroke (3 cyl) Carb	Manual Models	USA	0G960500 - 1B226999	398-852386T 6	N/A
		BEL	0P153500 - 0P400999		

Not all parts listed are available for the European, C.I.S., Africa and Middle East Markets.  
For more information, please contact your local Mercury, Mariner, MerCruiser or Quicksilver Office.

# ELECTRICAL SYSTEM

Model	Model Note	Serial # Range	Standard Stator	OPTIONAL Stator CONVERTS 9 AMP TO 16 AMP
40 FourStroke (3 cyl) Carb	Electric Models	USA 0G960500 - 1B226999	398-852387T 7	N/A
		BEL 0P153500 - 0P400999		
40 FourStroke	3 cylinder, Carb	USA 1B227000 - 1B344306	398-852386T 6	N/A
		BEL 0P401000 and up		
		CHN 1C000001 and up		
40 FourStroke	3 cylinder, EFI	USA 0G409000 - 1B344398	398-878143T05	N/A
		BEL 0P153500 - 0P515896		
		CHN 1C000001 and up		
40 FourStroke	4 cylinder, 935cc	USA 0G231123 - 0G760299	398-825089 1	N/A
40 FourStroke	4 cylinder, Carb, 996cc	USA 0T228405 - 0T598999	398-852387T 7	N/A
		BEL 0P094500 - 0P206999		
40 FourStroke	4 cylinder, EFI, 996cc	USA 0T409000 - 1B344306	398-878143T05	N/A
		BEL 0P151500 and up		
		CHN 1C000001 and up		
40 JET, FourStroke	4 cylinder	CHN 1C051324 and up	398-878143T05	N/A
45 (4 cyl)	Manual Models	USA 5531630 - 0B110788	76314A 3	N/A
		AUS 8063985 and up		
		BEL 9248006 - 9466691		
		CAN 7143688 - 0A719280		
45 (4 cyl)	Electric Models	USA 5531630 - 0B110788	398-832075A20	N/A
		AUS 8063985 and up		
		BEL 9248006 - 9466691		
		CAN 7143688 - 0A719280		
45 (4 cyl)	Manual Models	USA 0B110789 and up	398-832074A 6	N/A
		BEL 9466692 and up		
		CAN 0A719281 and up		
45 (4 cyl)	Electric Models	USA 0B110789 and up	398-832075A20	N/A
		BEL 9466692 and up		
		CAN 0A719281 and up		
45 FourStroke		USA 0G231123 - 0T178499	398-825089 1	N/A
		BEL 0P017000 - 0P016999		
50 (500)(4 cyl)		USA 2858814 - 4357639	N.L.A.	N/A
		AUS 2863739 - 8030089		
		BEL 9001581 - 9107213		
		CAN 2742142 - 7068997		
50 (500)(4 cyl)	Manual Models	USA 4357640 and up	76314A 3	N/A
		AUS 8030090 and up		
		BEL 9107214 and up		
		CAN 7068998 and up		
50 (500)(4 cyl)	Electric Models	USA 4357640 and up	398-832075A20	N/A
		AUS 8030090 and up		
		BEL 9107214 and up		
		CAN 7068998 and up		
50 (3 cyl)		USA 6428681 - 0D000749	398- 5704A 7	N/A
		BEL 9385911 - 9683054		
		CAN 7208333 and up		
50 (3 cyl)	With stator stamped 9710A22	USA 0D000750 - 0G290584	398- 9873A38	N/A
		BEL 9683055 - 9885344		
50 (3 cyl)	With stator stamped 9710A34	USA 0D000750 - 0G290584	398-832075A19	N/A
		BEL 9683055 - 9885344		
50 (3 cyl)	With stator stamped 9710A23	USA 0D000750 - 0G290584	398-832075A 5	N/A
		BEL 9683055 - 9885344		
50 (3 cyl)		USA 0G290585 - 0G589999	398-832075A 5	N/A
		BEL 9885345 - 9973099		



Model	Model Note		Serial # Range	Standard Stator	OPTIONAL Stator CONVERTS 9 AMP TO 16 AMP
50 (3 cyl)	Manual Models	USA	0G590000 - 0T999999	398-832074A11	N/A
		BEL	9973100 and up		
50 (3 cyl)	Electric Models	USA	0G590000 - 0T999999	398-832075A21	N/A
		BEL	9973100 and up		
50 FourStroke	935 cc	USA	0G231123 - 0T178499	398-825089 1	N/A
50 FourStroke, Carb	996 cc	USA	0T178500 - 0T598999	398-852387T 7	N/A
		BEL	0P094500 - 0P206999		
50 FourStroke (4 cyl) EFI	996 cc	USA	0T409000 and up	398-878143T05	N/A
		BEL	0P153500 and up		
		CHN	1C000001 and up		
55 (3 cyl)		USA	0D000750 - 0G589999	398-832075A21	N/A
		BEL	9741042 - 9973099		
55 (3 cyl)	Manual Models	USA	0G590000 and up	398-832074A11	N/A
		BEL	9973100 and up		
55 (3 cyl)	Electric Models	USA	0G590000 and up	398-832075A21	N/A
		BEL	9973100 and up		
60 (3 cyl)		USA	6428681 - 0D000749	398- 5704A 7	N/A
		BEL	9385911 - 9683054		
		CAN	7208333 and up		
60 (3 cyl)	With stator stamped 9710A22	USA	0D000750 - 0G290584	398- 9873A38	N/A
		BEL	9683055 - 9885344		
60 (3 cyl)	With stator stamped 9710A34	USA	0D000750 - 0G290584	398-832075A19	N/A
		BEL	9683055 - 9885344		
60 (3 cyl)	With stator stamped 9710A23	USA	0D000750 - 0G290584	398-832075A 5	N/A
		BEL	9683055 - 9885344		
60 (3 cyl)		USA	0G290585 - 0G589999	398-832075A 5	N/A
		BEL	9885345 - 9973099		
60 (3 cyl)	Manual Models	USA	0G590000 and up	398-832074A11	N/A
		BEL	9973100 and up		
60 (3 cyl)	Electric Models	USA	0G590000 and up	398-832075A21	N/A
		BEL	9973100 and up		
60 FourStroke	Carb	USA	0T178500 - 0T598999	398-852387T 7	N/A
		BEL	0P094500 - 0P206999		
60 FourStroke	EFI	USA	0T409000 and up	398-878143T05	N/A
		BEL	0P153500 and up		
		CHN	1C000001 and up		
65 (650)(3cyl)		USA	4382057 - 4571651	398- 5704A 7	N/A
		BEL	9112989 - 9135824		
		CAN	7073473 - 7087822		
65 JET (Electric)	With voltage regulator.	USA	0D283222 - 0G437999	398-832075A 5	N/A
65 JET (Electric)	Without voltage regulator.(1)	USA	0D283222 - 0G437999	398-832075A19	398-832075A 7
70 (3 cyl)		USA	4571652 - 0A996141	398- 5704A 7	N/A
		AUS	8042350 and up		
		BEL	9135825 - 9483120		
70 (3 cyl)	With voltage regulator.	CAN	7087823 - 7208332	398-832075A 5	N/A
		USA	0A996142 - 0B240450		
70 (3 cyl)	Without voltage regulator.(1)	BEL	9483121 - 9506480	398-832075A19	398-832075A 7
		USA	0A996142 - 0B240450		
70 (3 cyl)	With stator stamped 9710A14.	BEL	9483121 - 9506480	398-832075A 5	N/A
		USA	0B240451 - 0C221999		
		BEL	9506481 - 9589038		

# ELECTRICAL SYSTEM

Model	Model Note		Serial # Range	Standard Stator	OPTIONAL Stator CONVERTS 9 AMP TO 16 AMP
70 (3 cyl)	w/stator stamped 8778A16 & regulator	USA	0B240451 - 0C221999	398-832075A 5	N/A
		BEL	9506481 - 9589038		
70 (3 cyl)	w/stator stamped 8778A16 & no regulator.(1)	USA	0B240451 - 0C221999	N/A	398-832075A 7
		BEL	9506481 - 958038		
75 (4 cyl)		USA	6432901 and up	398- 5454A26	N/A
		BEL	9393856 and up		
		CAN	7208573 and up		
75 (3 cyl)		USA	0C222000 - 0D283221	398-832075A 5	N/A
		BEL	9589039 - 9793576		
75 (3 cyl)(Manual Models)		USA	0D283222 - 0G437999	398-832074A 4	N/A
		BEL	9793577 - 9926999		
75 (3 cyl)(Electric Models)	With voltage regulator.	USA	0D283222 - 0G437999	398-832075A 5	N/A
		BEL	9793577 - 9926999		
75 (3 cyl)(Electric Models)	Without voltage regulator.(1)	USA	0D283222 - 0G437999	398-832075A19	398-832075A 7
		BEL	9793577 - 9926999		
75 (3 cyl)	Manual Models	USA	0G438000 and up	398-832074A11	N/A
		BEL	9927000 and up		
75 (3 cyl)	Electric Models	USA	0G438000 and up	398-832075A21	N/A
		BEL	9927000 and up		
75 FourStroke	1596cc, Carb Models	USA	0G960500 - 1B226999	398-804262T	N/A
75 FourStroke	1596cc, EFI Models	USA	1B172291 - 1B366822	398-881336A03	N/A
75 FourStroke	2.1L	USA	2B095049 and up	300-8M0088059	N/A
80 (80, 800)(4 cyl)		USA	4831999 - 6432900	398- 5454A26	N/A
		AUS	8050200 and up		
		BEL	9177626 - 9393855		
		CAN	7110998 - 7208572		
80 (3 cyl)	With voltage regulator.	USA	0A996142 - 0B240450	398-832075A 5	N/A
		BEL	9483121 - 9506480		
80 (3 cyl)	Without voltage regulator.(1)	USA	0A996142 - 0B240450	398-832075A19	398-832075A 7
		BEL	9483121 - 9506480		
80 (3 cyl)	With stator stamped 9710A14.	USA	0B240451 and up	398-832075A 5	N/A
		BEL	9506481 and up		
80 (3 cyl)	w/stator stamped 8778A16 & regulator	USA	0B240451 and up	398-832075A 5	N/A
		BEL	9506481 and up		
80 (3 cyl)	w/stator stamped 8778A16 & no regulator.(1)	USA	0B240451 and up	N/A	398-832075A 7
		BEL	9506481 and up		
80 JET	With voltage regulator.	USA	0D283222 - 0G437999	398-832075A 6	N/A
80 JET	Without voltage regulator.	USA	0D283222 - 0G437999	398-832075A 8	N/A
80 JET		USA	0G438000 and up	398-832075A21	N/A
80 FourStroke	2.1L	USA	2B095049 and up	300-8M0088059	N/A
85 (850)(4 cyl)		USA	4366802 - 4831998	398- 5454A26	N/A
		AUS	8043775 - 8050199		
		BEL	9110014 - 9177625		
		CAN	7071373 - 7110997		
90 (90, 900)(6 cyl)		USA	4845301 - 5299505	398- 4793	N/A
		CAN	711698 - 7123762		
90 (6 cyl)		USA	5299506 and up	398- 5454A17	N/A
		AUS	8060545 and up		
		CAN	7147088 and up		
90 (3 cyl)	With voltage regulator.	USA	0A996142 - 0B240450	398-832075A 5	N/A
		BEL	9483121 - 9506480		

Model	Model Note		Serial # Range	Standard Stator	OPTIONAL Stator CONVERTS 9 AMP TO 16 AMP
90 (3 cyl)	Without voltage regulator.(1)	USA	0A996142 - 0B240450	398-832075A19	398-832075A 7
		BEL	9483121 - 9506480		
90 (3 cyl)	With stator stamped 9710A14.	USA	0B240451 and up	398-832075A 5	N/A
		BEL	9506481 and up		
90 (3 cyl)	w/stator stamped 8778A16 & regulator	USA	0B240451 and up	398-832075A 5	N/A
		BEL	9506481 and up		
90 (3 cyl)	w/stator stamped 8778A16 & no regulator.(1)	USA	0B240451 and up	N/A	398-832075A 7
		BEL	9506481 and up		
90 (3 cyl)		USA	0C222000 - 0D283221	398-832075A 5	N/A
		BEL	9589039 - 9793576		
90 (3 cyl)(Manual Models)		USA	0D283222 - 0G437999	398-832074A 4	N/A
		BEL	9793577 - 9926999		
90 (3 cyl)(Electric Models)	With voltage regulator.	USA	0D283222 - 0G437999	398-832075A 5	N/A
		BEL	9793577 - 9926999		
90 (3 cyl)(Electric Models)	Without voltage regulator.(1)	USA	0D283222 - 0G437999	398-832075A19	398-832075A 7
		BEL	9793577 - 9926999		
90 (3 cyl)	Manual Models	USA	0G438000 and up	398-832074A11	N/A
		BEL	9927000 and up		
90 (3 cyl)	Electric Models	USA	0G438000 and up	398-832075A21	N/A
		BEL	9927000 and up		
90 FourStroke	1596cc, Carb Models	USA	0G960500 - 1B226999	398-804262T	N/A
90 FourStroke	1596cc, EFI Models	USA	1B172291 - 1B366822	398-881336A03	N/A
90 FourStroke	2.1L	USA	2B094049 and up	300-8M0088059	N/A
100 (4 cyl)	With voltage regulator.	USA	0B209468 - 0D283221	398-832075A 6	N/A
		BEL	9523034 - 9793576		
100 (4 cyl)	Without voltage regulator.	USA	0B209468 - 0D283221	398-832075A 8	N/A
		BEL	9523034 - 9793576		
100 (4 cyl)	With voltage regulator.	USA	0D283222 - 0G437999	398-832075A 6	N/A
		BEL	9793577 - 9926999		
100 (4 cyl)	Without voltage regulator.	USA	0D283222 - 0G437999	398-832075A 8	N/A
		BEL	9793577 - 9926999		
100 (4 cyl)		USA	0G438000 and up	398-832075A21	N/A
		BEL	9927000 and up		
100 FourStroke	2.1L	USA	2B095049 and up	300-8M0088059	N/A
115 (115, 1150)(6 cyl)		USA	4855153 - 5314655	398- 4793	N/A
		AUS	8051950 - 8061119		
		CAN	7112248 - 7131212		
115 (115, 1150)(6 cyl)		USA	5314656 and up	398- 5454A17	N/A
		AUS	8061120 and up		
		CAN	7131213 and up		
115 (4 cyl)	With voltage regulator.	USA	0C10000 - 0D283221	398-832075A 6	N/A
		BEL	9559771 - 9793576		
115 (4 cyl)	Without voltage regulator.	USA	0C10000 - 0D283221	398-832075A 8	N/A
		BEL	9559771 - 9793576		
115 (4 cyl)	With voltage regulator.	USA	0D283222 - 0G437999	398-832075A 6	N/A
		BEL	9793577 - 9926999		
115 (4 cyl)	Without voltage regulator.	USA	0D283222 - 0G437999	398-832075A 8	N/A
		BEL	9793577 - 9926999		
115 (4 cyl)		USA	0G438000 and up	398-832075A21	N/A
		BEL	9927000 and up		
115 FourStroke EFI	1741cc	USA	0T178500 - 1B366822	398-881336T 2	N/A
115 FourStroke	2.1L	USA	2B095049 and up	300-8M0088059	N/A

Not all parts listed are available for the European, C.I.S., Africa and Middle East Markets.  
For more information, please contact your local Mercury, Mariner, MerCruiser or Quicksilver Office.

# ELECTRICAL SYSTEM

Model	Model Note	Serial # Range	Standard Stator	OPTIONAL Stator CONVERTS 9 AMP TO 16 AMP	
125 (4 cyl)	With voltage regulator.	USA	0D283222 - 0G437999	398-832075A 6	N/A
		BEL	9793577 - 9926999		
125 (4 cyl)	Without voltage regulator.	USA	0D283222 - 0G437999	398-832075A 8	N/A
		BEL	9793577 - 9926999		
125 (4 cyl)		USA	0G438000 and up	398-832075A21	N/A
		BEL	9927000 and up		
140 (140, 1400)(6 cyl)		USA	4865678 - 5327662	398- 4793	N/A
		AUS	8052650 - 8052879		
		CAN	7112773 - 7132512		
140 (6 cyl)		USA	5327663 and up	398- 5454A17	N/A
		CAN	7132513 and up		
V-105 JET		USA	0D082000 - 0G960499	398- 9610A19	N/A
V-135 Carbed	w/ 1/2 inch laminations on stator.	USA	0A904646 - 0C100860	398- 5454A32	N/A
V-135 Carbed	w/ 5/8 inch laminations on stator.	USA	0A904646 - 0C100860	398- 5454A35	N/A
V-135 Carbed		USA	0C100861 - 0C239552	398- 9610A 5	N/A
V-135 Carbed	Black 16 amp stator w/ non-louved cover & coated stator wires	USA	0C239553 - 0D081999	398- 5454A35	N/A
V-135 Carbed	Black 16 amp stator w/ louvred cover & coated stator wires	USA	0C239553 - 0D081999	398- 9873A 4	N/A
V-135 Carbed	Clear 40 amp stator w/ louvred cover & visible stator wires	USA	0C239553 - 0D081999	398- 9610A 5	N/A
V-135 Carbed		USA	0D082000 - 0G960499	398- 9610A19	N/A
V-135 Carbed		USA	0G960500 - 0T178499	398-858404T 4	N/A
V-140 JET		USA	0D082000 - 0G960499	398- 9610A19	N/A
V-150 Carbed		USA	4868998 - 0A904645	398- 5454A 7	N/A
V-150 Carbed	w/ 1/2 inch laminations on stator.	USA	0A904646 - 0C100860	398- 5454A32	N/A
V-150 Carbed	w/ 5/8 inch laminations on stator.	USA	0A904646 - 0C100860	398- 5454A35	N/A
V-150 Carbed		USA	0C100861 - 0C239552	398- 9610A 5	N/A
V-150 Carbed	Black 16 amp stator w/ non-louved cover & coated stator wires	USA	0C239553 - 0D081999	398- 5454A35	N/A
V-150 Carbed	Black 16 amp stator w/ louvred cover & coated stator wires	USA	0C239553 - 0D081999	398- 9873A 4	N/A
V-150 Carbed	Clear 40 amp stator w/ louvred cover & visible stator wires	USA	0C239553 - 0D081999	398- 9610A 5	N/A
V-150 Carbed		USA	0D082000 - 0G960499	398- 9610A19	N/A
V-150 Carbed		USA	0G960500 and up	398-858404T 4	N/A
V-150 EFI		USA	0D082000 - 0G960499	398- 9610A19	N/A
V-150 EFI		USA	0G960500 - 0T408999	398-858404T 4	N/A
V-150 XR4, Magnum II		USA	0B242885 - 0C100860	398- 5454A35	N/A
V-150 XR4, Magnum II		USA	0C100861 - 0C239552	398- 9610A 5	N/A
V-150 XR4, Magnum II	Black 16 amp stator w/ non-louved cover & coated stator wires	USA	0C239553 - 0D081999	398- 5454A35	N/A
V-150 XR4, Magnum II	Black 16 amp stator w/ louvred cover & coated stator wires	USA	0C239553 - 0D081999	398- 9873A 4	N/A
V-150 XR4, Magnum II	Clear 40 amp stator w/ louvred cover & visible stator wires	USA	0C239553 - 0D081999	398- 9610A 5	N/A
V-150 XR6, Magnum III		USA	0D082000 - 0G960499	398- 9610A19	N/A
V-150 XR6, Magnum III		USA	0G960500 and up	398-858404T 4	N/A
V-175 (175, 1750) Carbed		USA	4301235 - 6618750	398- 5454A 7	N/A
		AUS	8058870 and up		
V-175 Carbed	Without voltage regulator.	USA	6618751 - 0C100860	398- 5454A 7	N/A
V-175 Carbed	With voltage regulator and 1/2 inch stator laminations	USA	6618751 - 0C100860	398- 5454A32	N/A
V-175 Carbed	With voltage regulator and 5/8 inch stator laminations	USA	6618751 - 0C100860	398- 5454A35	N/A
V-175 Carbed		USA	0C100861 - 0C239552	398- 9610A 5	N/A

Model	Model Note		Serial # Range	Standard Stator	OPTIONAL Stator CONVERTS 9 AMP TO 16 AMP
V-175 Carbed	Black 16 amp stator w/ non-louvred cover & coated stator wires	USA	0C239553 - 0D081999	398- 5454A35	N/A
V-175 Carbed	Black 16 amp stator w/ louvred cover & coated stator wires	USA	0C239553 - 0D081999	398- 9873A 4	N/A
V-175 Carbed	Clear 40 amp stator w/ louvred cover & visible stator wires	USA	0C239553 - 0D081999	398- 9610A 5	N/A
V-175 Carbed		USA	0D082000 - 0G960499	398- 9610A19	N/A
V-175 EFI		USA	0D000749 - 0D081999	398- 9610A 5	N/A
V-175 EFI		USA	0D082000 - 0G960499	398- 9610A19	N/A
V-175 EFI		USA	0G960500 - 0T408999	398-858404T 4	N/A
V-200 (200, 2000) Carbed		USA	4839034 - 6625220	398- 5454A 7	N/A
		AUS	8061595 - 8065672		
V-200 Carbed	Without voltage regulator.	USA	6618751 - 0C100860	398- 5454A 7	N/A
V-200 Carbed	With voltage regulator and 1/2 inch stator laminations	USA	6618751 - 0C100860	398- 5454A32	N/A
V-200 Carbed	With voltage regulator and 5/8 inch stator laminations	USA	6618751 - 0C100860	398- 5454A35	N/A
V-200 Carbed	Black 16 amp stator w/ non-louvred cover & coated stator wires	USA	0C100861 - 0C291519	398- 5454A35	N/A
V-200 Carbed	Clear 40 amp stator w/ louvred cover & visible stator wires	USA	0C100861 - 0C291519	398- 9610A 5	N/A
V-200 Carbed	Black 16 amp stator w/ non-louvred cover & coated stator wires	USA	0C291520 - 0D081999	398- 5454A35	N/A
V-200 Carbed	Black 16 amp stator w/ louvred cover & coated stator wires	USA	0C291520 - 0D081999	398- 9873A 4	N/A
V-200 Carbed	Clear 40 amp stator w/ louvred cover & visible stator wires	USA	0C291520 - 0D081999	398- 9610A 5	N/A
V-200 Carbed		USA	0D082000 - 0G960499	398- 9610A19	N/A
V-200 EFI		USA	0C100861 - 0D081999	398- 9610A 5	N/A
V-200 EFI		USA	0D082000 - 0G960499	398- 9610A19	N/A
V-200 EFI (2.5L)		USA	0G960500 - 0T408999	398-858404T 4	N/A
V-220 Laser		USA	0B117316 and up	398- 5454A35	N/A
V-225 Carbed (2.4L)		USA	5628028 and up	398- 5454A 7	N/A
V-225 Carbed (3.0L)		USA	0D280813 - 0G129221	398-821935A 3	N/A
V-225 Carbed (3.0L)		USA	0G129222 - 0T408999	398-821935A 5	N/A
V-225 EFI		USA	0G129222 - 0T408999	398-821935A 5	N/A
V-250 EFI		USA	0G129222 - 0T408999	398-821935A 5	N/A
V-250 Carbed (3.4L)	Mounted with 4 standard screws and used with water cooled voltage regulator	USA	0C101891 and up	N.L.A.	N/A
V-250 Carbed (3.4L)	Mounted with 5 metric screws and used with water cooled voltage regulator	USA	0C101891 and up	N.L.A.	N/A
V-250 Carbed (3.4L)	Mounted with 5 metric screws and used with 815279T voltage regulator	USA	0C101891 and up	N.L.A.	N/A
V-300 Carbed (3.4L)		USA	5611648 and up	398- 5454A55	N/A

(1) Outboards using 16 amp kit will require the installation of a new style attenuator plate part no. 42970A 2, to provide a mounting location for the voltage regulator.

# ELECTRICAL SYSTEM

## STARTER MOTORS & COMPONENT PARTS

### STARTER MOTOR KIT



**50- 55601A 2**

40 Hp 2 Cyl. 2 Cycle

### STARTER MOTOR KIT



**50- 44369A 1**

50 - 60 Hp 3 Cyl.

### STARTER MOTOR ASSY.



**50-898265010**

90 - 140 Hp In-Line 6  
V-150,V-175, XR2

### STARTER MOTOR ASSY.



**50-803835T02**

9.9 hp. FourStroke Outboard, beginning with Model Year 2005.

### STARTER MOTOR ASSY.



**50-853805T03**

### STARTER MOTOR ASSY.



**50-859168T**

9.9 hp. FourStroke, 323cc., 1999-2004.  
15 hp. FourStroke, 323cc., 1998 & newer.

### STARTER MOTOR ASSY.



**50-881368T 2**

### STARTER MOTOR ASSY.



**50-888333T 1**

**STARTER MOTOR ASSY.**



**50-892339T01**

**STARTER MOTOR ASSY.**



**50-893886T**

**STARTER MOTOR ASSY.**



**50-893887T**

**STARTER MOTOR ASSY.**



**50-893888T**

**STARTER MOTOR ASSY.**



**50-893890T**

30 - 60 Hp 2 & 3 Cyl.

**STARTER MOTOR ASSY.**



**50-893891T**

65 - 90 Hp 3 Cyl.

**STARTER MOTOR ASSY.**



**50-893892T**

100, 115, 125 Hp 4 Cyl.

**STARTER MOTOR ASSY.**



**50-893893**

135 - 200 Hp 2.5L V-6

# ELECTRICAL SYSTEM

## STARTER MOTOR KIT



50-879150A85

## STARTER MOTOR ASSY.

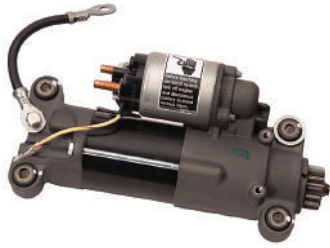

50-879345T77

## STARTER MOTOR ASSY.



50-898265001

45-50 FourStroke

## STARTER MOTOR ASSY.



50-898265003

## STARTER MOTOR ASSY.



50-898265005

40 - 50 Hp 4 Cyl.

## STARTER MOTOR



50-898265008

## STARTER MOTOR



50-898265009

## STARTER MOTOR ASSY.



50-898265010

90 - 140 Hp In-Line 6  
V-150,V-175, XR2



**STARTER MOTOR ASSY.**



**50-8M0033984**

9.9 - 25 Hp

**STARTER MOTOR**

Image not Available.

**50-8M0088064**

**50-8M0096343**

**INTERNAL SOLENOID**



**881371T 1**

An integral part of the starter assembly.

**INTERNAL SOLENOID**



**888339A 1**

An integral part of the starter assembly.

**STARTER DRIVE**



**68575 3**

**STARTER DRIVE**



**57380**

**STARTER DRIVE**



**13310T 1**

**STARTER DRIVE**



**96562**

**STARTER DRIVE**



**803836**

9.9 hp. FourStroke Outboard, beginning with Model Year 2005.

**ELECTRICAL SYSTEM**

**STARTER DRIVE**



804319

**STARTER DRIVE**



853806 1

**STARTER DRIVE**



43-880805A 1

**STARTER DRIVE**



13310T 2

**DRIVE RETAINER KIT**



90643

**DRIVE RETAINER KIT**



90643 1

**DRIVE RETAINER KIT**



90643 2

**DRIVE RETAINER KIT**

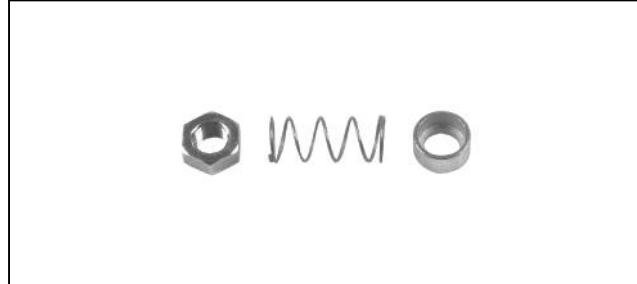

90645

**DRIVE RETAINER KIT**



804320

**DRIVE RETAINER KIT**



820620

**DRIVE KIT**



**823640T**

**STARTER DRIVE**



**898265015**

**DRIVE RETAINER KIT**



**823640 1**

**STARTER MOTORS AND COMPONENTS CHARTS**

**Mercury/Mariner Starter Motors**

Original Starter Motor	Pinion Teeth	New Replacement Starter Motor	Original Brush Set	Original Drive Assy	Original Drive Retainer Kit	Drive Cap	Commutator Cap	Internal Solenoid
38890A 1	9	50- 55601A 2	N.L.A.	N.L.A.	N.L.A.	N.L.A.	N.L.A.	N/A
41583T	10	50-898265007(3)	898265016	N.L.A.	N.L.A.	N.L.A.	N.L.A.	N/A
44369A 1	10	50- 44369A 1	898265016	68575 3	90643	75660	N.L.A.	N/A
45822A 1	10	N.L.A.	N.L.A.	N.L.A.	N.L.A.	N.L.A.	N.L.A.	N/A
47216	10	N.L.A.	N.L.A.	N.L.A.	N.L.A.	N.L.A.	N.L.A.	N/A
55601	9	50- 55601A 2	898265016	57380	N.L.A.	N.L.A.	N.L.A.	N/A
55601A 2	9	50- 55601A 2	898265016	N.L.A.	N.L.A.	N.L.A.	N.L.A.	N/A
57465A 1	10	50-898265010	N.L.A.	N.L.A.	N.L.A.	N.L.A.	N.L.A.	N/A
57867A 1	10	N.L.A.	N.L.A.	N.L.A.	N.L.A.	N.L.A.	N.L.A.	N/A
58788	10	N.L.A.	N.L.A.	N.L.A.	N.L.A.	N.L.A.	N.L.A.	N/A
58788A 3	10	N.L.A.	N.L.A.	N/A	N.L.A.	N.L.A.	N.L.A.	N/A
60315	10	50- 44369A 1	N.L.A.	N/A	N.L.A.	N.L.A.	N.L.A.	N/A
64975	10	50-898265010	N.L.A.	N/A	N.L.A.	N.L.A.	N.L.A.	N/A
65436	10	50- 44369A 1	N.L.A.	68575 3	90643	NSS	15386001	N/A
66015 2	10	50-893891T	898265016	68575 3	90643	75660	15386001	N/A
66015 3	8	50-893892T	898265016	13310T 1	N.L.A.	75660	15386001	N/A
67341	10	N.L.A.	898265016	68575 3	90643	N.L.A.	N.L.A.	N/A
72467	10	50-898265010	898265016	68575 3	90643	75660	15386001	N/A
73521T	10	50-898265005	898265016	68575 3	90643	75660	N.L.A.	N/A
73531	10	N.L.A.	N/A(1)	96562	N.L.A.	N.L.A.	N.L.A.	N/A
76275	10	N.L.A.	N/A(1)	96562	N.L.A.	N.L.A.	N.L.A.	N/A
77141	8	50-893893	898265016	13310T 1	90645	75660	15386001	N/A
78011	10	N.L.A.	N/A(1)	96562	N.L.A.	N.L.A.	N.L.A.	N/A
79472 1	8	50-893893	898265016	13310T 1	90645	75660	15386001	N/A
79472T 2	8	50-893893	898265016	13310T 2	90645	75660	15386001	N/A

Not all parts listed are available for the European, C.I.S., Africa and Middle East Markets.  
 For more information, please contact your local Mercury, Mariner, MerCruiser or Quicksilver Office.

# ELECTRICAL SYSTEM

Original Starter Motor	Pinion Teeth	New Replacement Starter Motor	Original Brush Set	Original Drive Assy	Original Drive Retainer Kit	Drive Cap	Commutator Cap	Internal Solenoid
86976	9	N.L.A.	898265016	898265015	N.L.A.	75660	15386001	N/A
88656	10	N.L.A.	N.L.A.	N.L.A.	N.L.A.	N.L.A.	N.L.A.	N/A
90983A 1	10	50-8M0033984	N/A(1)	96562	N.L.A.	96563T	N.L.A.	N/A
90983T 1	10	50-8M0033984	N/A(1)	96562	N.L.A.	96563T	N.L.A.	N/A
97949A 1	10	N.L.A.	N.L.A.	N.L.A.	N.L.A.	N.L.A.	N.L.A.	N/A
803835T02		50-803835T02	803837A02	803836	N/A	N/A	N/A	N/A
818445 5	8	50-898265009	898265016	13310T 1	823640T	N.L.A.	N.L.A.	N/A
819968 4		50-898265003	F15190	N.L.A.	820620	N.L.A.	852082	N/A
822462T 1	10	50-893890T	898265016	68575 3	90643	N.L.A.	N.L.A.	N/A
830308	9	50-893886T	898265016	N.L.A.	90643 2	N.L.A.	N.L.A.	N/A
832997 2	8		898265016	13310T 1	90645	851990	N.L.A.	N/A
833153 5	9	50-898265008	898265016	898265015	823640 1	N.L.A.	N.L.A.	N/A
834749	9	50-898265001	898265016	N.L.A.	90643 1	N.L.A.	N.L.A.	N/A
852570	9	50-859168T	898265016	N.L.A.	90643 2	N.L.A.	N.L.A.	N/A
853329T	14	50-892339T01	NSS	43-880805A 1	NSS(2)	NSS	NSS	N/A
853805T03		50-853805T03	853807T02	853806 1	NSS(2)	NSS	NSS	N/A
854636T	9	50-893887T	898265016	N/A	90643 2	N.L.A.	N.L.A.	N/A
859169T	9	50-893886T	898265016	N.L.A.	N.L.A.	N.L.A.	N.L.A.	N/A
859170T	9	50-893887T	898265016	N.L.A.	N.L.A.	N.L.A.	N.L.A.	N/A
859170T 1	9	50-893887T	898265016	N.L.A.	N.L.A.	N.L.A.	N.L.A.	N/A
859171T	9	50-898265001	898265016	N.L.A.	N.L.A.	N.L.A.	N.L.A.	N/A
879150A85	14	50-879150A85	NSS	NSS	NSS	NSS	NSS	NSS
884044T	9	50-893888T	898265016	N.L.A.	N.L.A.	N.L.A.	N.L.A.	N/A
884045T	9	50-893887T	898265016	N.L.A.	N.L.A.	N.L.A.	N.L.A.	N/A
881368T 1	13	50-881368T 2	804316	804319	804320	N/A	881370T	881371T 1
881368T 2	13	50-881368T 2	804316	804319	804320	N/A	881370T	881371T 1
888151T	9	50-893886T	898265016	N.L.A.	N.L.A.	N.L.A.	N.L.A.	N/A
888160T	9	50-893887T	898265016	N.L.A.	N.L.A.	N.L.A.	N.L.A.	N/A
888161T	9	50-893888T	898265016	N.L.A.	N.L.A.	N.L.A.	N.L.A.	N/A
888333T 1	13	50-888333T 1	888335	804319	804320	N/A	881370T	888339A 1
892339T	14	50-892339T01	NSS	43-880805A 1	NSS(2)	NSS	NSS	809463A 1
892339T01	14	50-892339T01	8M0065258	43-880805A 1	NSS(2)	NSS	NSS	809463A 1
893886T	9	50-893886T	NSS	NSS	NSS	NSS	NSS	N/A
893887T	9	50-893887T	NSS	NSS	NSS	NSS	NSS	N/A
893888T	9	50-893888T	NSS	NSS	NSS	NSS	NSS	N/A
893890T	10	50-893890T	898265016	68575 3	90643	N.L.A.	N.L.A.	N/A
893891T	10	50-893891T	898265016	68575 3	90643	75660	15386001	N/A
893892T	8	50-893892T	NSS	NSS	NSS	NSS	NSS	N/A
879345T77	14	50-879345T77	NSS	NSS	NSS	NSS	NSS	NSS
897525T03	14	50-879150A85	NSS	NSS	NSS	NSS	NSS	NSS
897525T05	14	50-879150A85	NSS	NSS	NSS	NSS	NSS	NSS
898265003		50-898265003	NSS	NSS	NSS	NSS	NSS	NSS
8M0074530		50-8M0096343	NSS	NSS	NSS	NSS	NSS	NSS
8M0079328		50-8M0096343	NSS	NSS	NSS	NSS	NSS	NSS
8M0088064		50-8M0088064	NSS	NSS	NSS	NSS	NSS	NSS
8M0096343		50-8M0096343	NSS	NSS	NSS	NSS	NSS	NSS

(1) Brushes and springs are part of the End Cap Assembly.

(2) Retaining ring included with pinion gear.

(3) Order from Land N Sea

**SOLENOIDS - STARTER & POWER TRIM**

**STARTER RELAY**



**825096T01**

**SOLENOID**



**25661T 1**

**SOLENOID**



**89- 96054T**

Flat mounting plate  
Fits In-Line 6 Outboards & MerCruiser engines

**SOLENOID**



**89- 96158T**

Stepped mounting plate  
Fits Outboard Starters & MerCruiser Starters and Pwr Trim.

**STARTER SOLENOID**



**809463A 1**

For MCM Delco Remy PG 260 series starter and found in numerous outboard applications from the 75/90 (1.5L) through the 225 hp. DFI engines, 3.0L EFI product and also the 200-300 hp. Verado.

**SOLENOID**



**89-817109A 2**

Fits Outboard 3 Cyl. - V-6

**SOLENOID**



**89-818999A 2**

**SOLENOID**



**89-850187T 1**

# ELECTRICAL SYSTEM

## SOLENOID



**89-850188T 1**

Fits Outboard 6 - 25 Hp and 50 - 60 Hp 3 Cyl. & MCM applications

## SOLENOID



**89-850189T**

## SOLENOID



**89-853654A 1**

Fits Outboard 2 Cyl. & In-Line 6 & MCM applications

## SOLENOID



**89-853809001**

Used on the 9.9 hp. FourStroke (electric model) outboard, beginning with Model Year 2005 and the 25/30 hp. EFI FourStroke outboards beginning with serial number OR106999.

## POWER TRIM SOLENOID



**89-818997T 1**

## POWER TRIM SOLENOID



**89-818864T**

## RELAYS - POWER TRIM

### RELAY



**882751**

### POWER TRIM RELAY



**882751A 1**

**POWER TRIM RELAY**

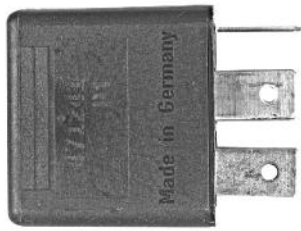

**87- 18211**

**POWER TRIM RELAY**



**87- 19761**

**RELAY**



**821509T01**

**RELAY**



**87-851839T02**

Used on the 9.9 hp. FourStroke (electric model) outboard, beginning with Model Year 2005.

**RELAY**



**881352T**

**RELAY**



**881356001**

**RELAY**



**888320T**

**POWER TRIM RELAY KIT**



**882751A 3**

# ELECTRICAL SYSTEM

## RELAY



**882751A04**

Used on 200/225/250/275 Verado outboards beginning with Model Year 2005. Also used on MCM 496 & MIE 8.1L.

## SOLENOID AND RELAY CHART - MERCURY/MARINER

### FourStroke Solenoid and Relay Chart

Model	Model Notes	Serial # Range	Starter Solenoid/Relay	Power Trim Relay
4 FourStroke		JPN 0R000001 and up	N/A	N/A
		BEL 0P073456 and up		
5 FourStroke		JPN 0R000001 and up	N/A	N/A
		BEL 0P073456 and up		
6 FourStroke		JPN 0R000001 and up	N/A	N/A
		BEL 0P073456 and up		
8 FourStroke	232cc	USA 0G760300 - 0T178499	N.L.A.	N/A
		USA 0H017100 - 0H017349		
8 FourStroke	323cc	BEL 0P075166 - 0P325499	825096T01	N/A
9.9 FourStroke	232cc	USA 0H000058 - 0H016909	N.L.A.	N/A
9.9 FourStroke	323cc	USA 0G760300 - 0T979999	825096T01	N/A
		BEL 0P075166 - 0P325499		
9.9 FourStroke	209cc	JPN 0R042475 and up	89-853809001	87-851839T02
		BEL 0P325500 and up		
15 FourStroke	323cc	USA 0G760300 - 1B727495	825096T01	N/A
		BEL 0P075166 and up		
15 FourStroke	351cc	JPN 0R235949 and up	89-853809002	87-851839T02
20 FourStroke	351cc	JPN 0R235168 and up	89-853809002	87-851839T02
25 FourStroke	Carb	USA 0G590000 - 1B344298	89-850187T 1	N/A
		BEL 9973100 - 0P388282		
25 FourStroke	EFI	JPN 0R106999 and up	89-853809001	(3)
30 FourStroke	Carb	USA 0G760300 and up	89-850187T 1	882751A 1
		BEL 0P153500 and up		
30 FourStroke	EFI	USA 0T409000 - 1B226999	825096T01	882751A 1
30 FourStroke	EFI	JPN 0R106999 and up	89-853809001	(3)
40 FourStroke	Carb, 3 cylinder	USA 0G760300 and up	89-850187T 1	882751A 1
		BEL 0P153500 and up		
40 FourStroke	EFI, 3 cylinder	USA 0T409000 and up	825096T01	882751A 1
		BEL 0P153500 and up		
		CHN 1C000001 and up		
40 FourStroke	Carb, 4 cylinder	USA 0T228405 - 0T598999	825096T01	882751A 1
		BEL 0P094500 - 0P206999		
40 FourStroke	EFI, 4 cylinder	USA 0T409000 and up	825096T01	882751A 1
		BEL 0P153500 and up		
		CHN 1C000001 and up		
45 FourStroke	Bodensee	USA 0G231123 - 0G472132	825096T01	821509T01



Model	Model Notes	Serial # Range	Starter Solenoid/Relay	Power Trim Relay
45 FourStroke	Bodensee	USA 0G472133 - 0T178499	825096T01	882751A 1
50 FourStroke		USA 0G231123 - 0T178499	825096T01	821509T01
50 FourStroke	Carb, 4 cylinder, 996cc	USA 0T178500 - 0T598999	825096T01	882751A 1
		BEL 0P094500 - 0P206999		
50 FourStroke	EFI, 4 cylinder, 996cc	USA 0T409000 and up	825096T01	882751A 1
		BEL 0P153500 and up		
		CHN 1C000001 and up		
60 FourStroke	Carb, 4 cylinder, 996cc	USA 0T178500 - 0T598999	825096T01	882751A 1
		BEL 0P094500 - 0P206999		
60 FourStroke	EFI, 4 cylinder, 996cc	USA 0T409000 and up	825096T01	882751A 1
		BEL 0P153500 and up		
		CHN 1C000001 and up		
75 FourStroke	Carb, 1596cc	USA 0G960500 - 1B226999	825096T01	(2)
		BEL 0P094500 - 0P400999		
75 FourStroke	EFI, 1596cc	USA 1B172291 - 1B366822	881352T	881356001
75 FourStroke	EFI, 1731cc	USA 1B366823 - 2B094995	89-817109A 2	882751
		BEL 0P459572 and up		
75 FourStroke	2.1L	USA 2B094996 and up	882751	882751
90 FourStroke	Carb, 1596cc	USA 0G960500 - 1B226999	825096T01	(2)
		BEL 0P094500 - 0P400999		
90 FourStroke	EFI, 1596cc	USA 1B172291 - 1B366822	881352T	881356001
90 FourStroke	EFI, 1731cc	USA 1B366823 - 2B094995	89-817109A 2	882751
		BEL 0P459572 and up		
90 FourStroke	2.1L	USA 2B094996 and up	882751	882751
115 FourStroke	EFI, w/single relay trim	USA 0T178500 - 0T800999	881352T	882751A 3
115 FourStroke	EFI, w/two relay trim	USA 0T178500 - 0T800999	881352T	882751A 1
115 FourStroke	EFI, 1741cc	USA 0T809000 - 1B366822	881352T	882751A 1
115 FourStroke	EFI, 1731cc	USA 1B366823 - 2B094995	89-817109A 2	882751
		BEL 0P459572 and up		
115 FourStroke	2.1L	USA 2B094996 and up	882751	882751
135 FourStroke	Verado	USA 1B227000 and up	882751A04	882751A04
		BEL 0P419487 and up		
150 FourStroke	EFI	USA 1B905505 and up	8M0057697	8M0057697
150 FourStroke	Verado	USA 1B227000 and up	882751A04	882751A04
		BEL 0P419487 and up		
175 FourStroke	Verado	USA 1B227000 and up	882751A04	882751A04
		BEL 0P419487 and up		
200 FourStroke	4 cyl., Verado	USA 1B517159 and up	882751A04	882751A04
		BEL 0P514869 and up		
200 FourStroke	6 cyl., Verado	USA 0T980000 and up	882751A04	882751A04
		BEL 0P409357 and up		
225 FourStroke	EFI	USA 0T653945 and up	881352T	888320T
225 FourStroke	6 cyl., Verado	USA 0T980000 and up	882751A04	882751A04
		BEL 0P409357 and up		
250 FourStroke	6 cyl., Verado	USA 0T980000 and up	882751A04	882751A04
		BEL 0P409357 and up		
275 FourStroke	6 cyl., Verado	USA 0T980000 and up	882751A04	882751A04
		BEL 0P409357 and up		
300 FourStroke	6 cyl., Verado	USA 1B517434 and up	882751A04	882751A04
		BEL 0P520553 and up		
350Sci FourStroke	6 cyl., Verado (Race)	USA 1B716557 and up	882751A04	882751A04

(2) For an UP relay order 804281T. For a DOWN relay order 804282T.

(3) For an UP relay order 898103T09. For a DOWN relay order 898103T10.

# ELECTRICAL SYSTEM

## 2-Cycle Solenoid and Relay Chart

Model	Model Notes	Serial # Range	Starter Solenoid	Power Trim Solenoid	Power Trim Relay
6		USA 0A197112 - 0D280999	89- 96054T	N/A	N/A
		BEL 9461526 - 9792199			
6		USA 0D281000 - 0T800749	89-850189T	N/A	N/A
		BEL 9792200 and up			
8		USA 0A197112 - 0D280999	89- 96054T	N/A	N/A
		BEL 9461526 - 9792199			
8		USA 0D281000 and up	89-850189T	N/A	N/A
		BEL 9792200 and up			
9.9		USA 0A197112 - 0D280999	89- 96054T	N/A	N/A
		BEL 9461526 - 9792199			
9.9		USA 0D281000 and up	89-850189T	N/A	N/A
		BEL 9792200 and up			
18 (18, 18XD)		USA 5837437 and up	89- 96054T	N/A	N/A
		AUS 8071973 and up			
		BEL 9308306 and up			
		CAN 7173723 and up			
20 (200, 20)		USA 4709593 - 6443972	89-853654A 1	N/A	N/A
		AUS 8045199 and up			
		BEL 9157230 - 9415100			
		CAN 7098523 - 7209532			
20 (20, 20XD)		USA 6443973 - 0G044026	89- 96054T	N/A	N/A
		BEL 9415101 - 9807908			
		CAN 7209533 and up			
20		USA 0G044027 - 0T979999	89-850188T 1	N/A	N/A
		BEL 9807909 and up			
20 JET		USA 0G044027 and up	89-850188T 1	N/A	N/A
		BEL 9807909 - 0P325499			
25 (25, 25XD)(2 cyl)	2 cylinder	USA 5705532 - 0G044026	89- 96054T	N/A	N/A
		AUS 8073158 and up			
		BEL 9315316 - 9807908			
		CAN 7166928 and up			
25	2 cylinder	USA 0G044027 and up	89-850188T 1	N/A	N/A
		BEL 9807909 and up			
30	2 cylinder, 644cc	USA 0G053314 and up	89-850187T 1	N/A	882751A 1
		BEL 0P017000 and up			
30	2 cylinder, 430cc	USA 0G575500 and up	89-853809T	N/A	N/A
30 JET	Non-handle	USA 0C159200 - 0G589999	89- 96054T	N/A	N/A
30 JET	Non-handle	USA 0G590000 - 0T178499	89-850187T 1	N/A	N/A
35	2 cylinder w/3 Ram Trim	USA 6445653 - 0C159199	89- 96158T	89- 96158T	N/A
		BEL 9384476 and up			
		CAN 7209608 and up			
35	2 cylinder w/1 Ram Trim	USA 0C159200 and up	89- 96158T	N/A	87- 18211
		BEL			
40 (40, 402, 400)	2 cylinder	USA 2874704 - 5556229	25661T 1	N/A	N/A
		AUS 8002335 - 8064749			
		BEL 3339688 - 9251455			
		CAN 3340783 - 7144762			
40	2 cylinder	USA 5556230 - 5823917	89-853654A 1	N/A	N/A
		AUS 8064750 - 8070639			
		BEL 9251456 - 9298955			
		CAN 7144763 - 7169337			

Model	Model Notes	Serial # Range	Starter Solenoid	Power Trim Solenoid	Power Trim Relay
40	2 cylinder	USA 5823918 - 0G053313	89- 96158T	N/A	N/A
		AUS 8070640 and up			
		BEL 9298956 and up			
		CAN 7169338 and up			
40	2 cylinder	USA 0G053314 and up	89-850187T 1	N/A	882751A 1
40	3 cylinder	USA 0G531301 - 0T999999	89-850187T 1	N/A	882751A 1
		BEL 9973100 and up			
40	4 cylinder w/solenoids	USA 0C159200 and up	89- 96054T	89-818999A 2	N/A
		BEL 9570790 and up			
40	4 cylinder w/relays	USA 0C159200 and up	89- 96054T	N/A	87- 19761
		BEL 9570790 and up			
40 JET	3 cylinder	USA 0T178500 and up	89-850187T 1	N/A	882751A 1
45	4 cylinder wo/trim circuit breaker & fuse	USA 5531630 - 6146848	89-853654A 1	89-853654A 1	N/A
		AUS 8063985 - 8075602			
		BEL 9248006 - 9362390			
		CAN 7143688 - 7198592			
45	4 cylinder w/trim circuit breaker & fuse	USA 5531630 - 6146848	89-853654A 1	89- 96158T	N/A
		AUS 8063985 - 8075602			
		BEL 9248006 - 9362390			
		CAN 7143688 - 7198592			
45	4 cylinder wo/trim circuit breaker & fuse	USA 6146849 - 0B110788	89- 96158T	89-853654A 1	N/A
		BEL 9362391 - 9466691			
		CAN 7198593 - 0A719280			
45	4 cylinder w/trim circuit breaker & fuse	USA 6146849 - 0B110788	89- 96158T	89- 96158T	N/A
		BEL 9362391 - 9466691			
		CAN 7198593 - 0A719280			
45 (4 cyl)	4 cylinder	USA 0B110789 and up	89- 96158T	89- 96158T	N/A
		BEL 9466692 and up			
		CAN 0A719281 and up			
45 JET	w/flush mount starter solenoid	USA 0D000750 - 0G290584	89- 96054T	N/A	N/A
45 JET	w/rubber bushing mount starter solenoid	USA 0D000750 - 0G290584	89-850188T 1	N/A	N/A
45 JET		USA 0G290585 - 0G589999	89-818999A 2	N/A	N/A
45 JET		USA 0G590000 - 0T178499	89-850187T 1	N/A	N/A
50 (500)		USA 2858814 - 3008818	N.L.A.	N/A	N/A
		AUS 2863739 - 3015353			
		CAN 2742142 - 3015453			
50 (500)		USA 3008819 - 4140999	25661T 1	N/A	N/A
		AUS 3015354 - 8029514			
		BEL 9001581 - 9082513			
		CAN 3015454 - 7051982			
50 (50, 500)		USA 4141000 - 5531629	89-853654A 1	N/A	N/A
		AUS 8029515 - 8063984			
		BEL 9082514 - 9248005			
		CAN 7051983 - 7143687			
50	4 cylinder wo/trim circuit breaker & fuse	USA 5531630 - 6146848	89-853654A 1	89-853654A 1	N/A
		AUS 8063985 - 8075602			
		BEL 9248006 - 9362390			
		CAN 7143688 - 7198592			
50	4 cylinder w/trim circuit breaker & fuse	USA 5531630 - 6146848	89-853654A 1	89- 96158T	N/A
		AUS 8063985 - 8075602			
		BEL 9248006 - 9362390			
		CAN 7143688 - 7198592			

# ELECTRICAL SYSTEM

Model	Model Notes	Serial # Range	Starter Solenoid	Power Trim Solenoid	Power Trim Relay
50	4 cylinder w/trim circuit breaker & fuse	USA 6146849 and up	89- 96158T	89-853654A 1	N/A
		BEL 9362391 and up			
		CAN 7198593 and up			
50	4 cylinder w/trim circuit breaker & fuse	USA 6146849 and up	89- 96158T	89- 96158T	N/A
		BEL 9362391 and up			
		CAN 7198593 and up			
50	3 cylinder	USA 6428681 - 0B122929	89- 96054T	89- 96158T	N/A
		BEL 9385911 - 9469199			
		CAN 7208333 - 0A721308			
50	3 cylinder w/3 Ram Trim	USA 0B122930 - 0D000749	89- 96158T	89- 96158T	N/A
		BEL 9469200 - 9683054			
		CAN 0A721309 and up			
50	3 cylinder w/1 Ram Trim	USA 0B122930 - 0D000749	89- 96158T	N/A	87- 18211
		BEL 9469200 - 9683054			
		CAN 0A721309 and up			
50	3 cylinder w/flush mount starter solenoid	USA 0D000750 - 0G290584	89- 96054T	N/A	882751A 1
		BEL 9683055 - 9885344			
50	3 cylinder w/rubber mount starter solenoid	USA 0D000750 - 0G290584	89-850188T 1	N/A	882751A 1
		BEL 9683055 - 9885344			
50	3 cylinder	USA 0G290585 - 0G589999	89-818999A 2	N/A	882751A 1
		BEL 9885345 - 9973099			
50	3 cylinder	USA 0G590000 and up	89-850187T 1	N/A	882751A 1
		BEL 9973100 and up			
55	3 cylinder w/flush mount starter solenoid	USA 0D000750 - 0G290584	89- 96054T	N/A	882751A 1
		BEL 9683055 - 9885344			
55	3 cylinder w/rubber mount starter solenoid	USA 0D000750 - 0G290584	89-850188T 1	N/A	882751A 1
		BEL 9683055 - 9885344	89-850188T 1	N/A	882751A 1
55	3 cylinder	USA 0G290585 - 0G589999	89-818999A 2	N/A	882751A 1
		BEL 9885345 - 9973099			
55	3 cylinder	USA 0G590000 and up	89-850187T 1	N/A	882751A 1
		BEL 9973100 and up			
60	3 cylinder	USA 6428681 - 0B122929	89- 96054T	89- 96158T	N/A
		BEL 9385911 - 9469199			
		CAN 7208333 - 0A721308			
60	3 cylinder w/3 Ram Trim	USA 0B122930 - 0D000749	89- 96158T	89- 96158T	N/A
		BEL 9469200 - 9683054			
		CAN 0A721309 and up			
60	3 cylinder w/1 Ram Trim	USA 0B122930 - 0D000749	89- 96158T	N/A	87- 18211
		BEL 9469200 - 9683054			
		CAN 0A721309 and up			
60	3 cylinder w/flush mount starter solenoid	USA 0D000750 - 0G290584	89- 96054T	N/A	882751A 1
		BEL 9683055 - 9885344			
60	3 cylinder w/rubber mount starter solenoid	USA 0D000750 - 0G290584	89-850188T 1	N/A	882751A 1
		BEL 9683055 - 9885344			
60	3 cylinder	USA 0G290585 - 0G589999	89-818999A 2	N/A	882751A 1
		BEL 9885345 - 9973099			
60	3 cylinder	USA 0G590000 and up	89-850187T 1	N/A	882751A 1
		BEL 9973100 and up			
65 (650)	4 cylinder	1542745 - 2446774	N.L.A.	N/A	N/A
65 (650)	4 cylinder	2446775 - 3293183	25661T 1	N/A	N/A

Model	Model Notes	Serial # Range	Starter Solenoid	Power Trim Solenoid	Power Trim Relay	
65 (650)	3 cylinder	USA 3547987 - 4571651	89-853654A 1	N/A	N/A	
		AUS 8006640 - 8042349				
		BEL 9020074 - 9135824				
		CAN 7013633 - 7087822				
65 JET		USA	89-850187T 1	N/A	N/A	
65 JET		USA	0G127500 and up	89-817109A 2	N/A	N/A
70	3 cylinder	USA 4571652 - 5579016	89-853654A 1	N/A	N/A	
		AUS 8042350 - 8065064				
		BEL 9135825 - 9255130				
		CAN 7087823 - 7145937				
70	3 cylinder	USA 5579017 - 6104369	89-853654A 1	89-853654A 1	N/A	
		AUS 8065065 - 8068964				
		BEL 9255131 - 9352915				
		CAN 7145938 - 7192547				
70	3 cylinder	USA 6104370 - 6428680	89- 96054T	89-853654A 1	N/A	
		BEL 9352916 - 9385910				
		CAN 7192548 - 7208332				
70	3 cylinder	USA 0A996142 - 0C221999	89- 96158T	89- 96158T	N/A	
		BEL 9483121 - 9589038				
75	4 cylinder	USA 6432901 and up	89- 96054T	89- 96158T	N/A	
		BEL 9393856 and up				
		CAN 7208573 and up				
75	3 cylinder w/3 Ram Trim	USA 0C222000 - 0D252460	89-850187T 1	89-850187T 1	N/A	
		BEL 9589039 and up				
75	3 cylinder w/1 Ram Trim	USA 0C222000 - 0D252460	89-850187T 1	N/A	882751A 1	
		BEL 9589039 and up				
75	3 cylinder w/1 Ram Trim	USA 0D252461 - 0D283221	89-850187T 1	89-818997T 1	N/A	
		BEL				
75	3 cylinder	USA 0D283222 - 0G127499	89-850187T 1	89-818997T 1	N/A	
		BEL 9793577 - 9836632				
75	3 cylinder	USA 0G127500 - 0G360002	89-817109A 2	89-818997T 1	N/A	
		BEL 9836633 - 9934136				
75	3 cylinder	USA 0G360003 and up	89-817109A 2	N/A	882751A 1	
		BEL 9934137 and up				
75 Optimax	3 cylinder, 1.5L	USA 0T801000 and up	89-817109A 2	N/A	882751A 1	
80 (800)	4 cylinder	2559001 - 3493912	25661T 1	N/A	N/A	
80 (800)	4 cylinder	USA 4831999 - 5582561	89-853654A 1	N/A	N/A	
		AUS 8050200 - 8067014				
		BEL 9177626 - 9256130				
		CAN 7110998 - 7146212				
80	4 cylinder wo/trim circuit breaker & fuse	USA 5582562 - 6030903	89-853654A 1	89-853654A 1	N/A	
		AUS 8067015 - 8074612				
		BEL 9256131 - 9345615				
		CAN 7146213 - 7189007				
80	4 cylinder w/trim circuit breaker & fuse	USA 5582562 - 6030903	89-853654A 1	89- 96158T	N/A	
		AUS 8067015 - 8074612				
		BEL 9256131 - 9345615				
		CAN 7146213 - 7189007				
80	4 cylinder wo/trim circuit breaker & fuse	USA 6030903 - 6432900	89- 96054T	89-853654A 1	N/A	
		AUS 8074612 and up				
		BEL 9345615 - 9393855				
		CAN 7189007 - 7208572				

Not all parts listed are available for the European, C.I.S., Africa and Middle East Markets.  
 For more information, please contact your local Mercury, Mariner, MerCruiser or Quicksilver Office.

# ELECTRICAL SYSTEM

Model	Model Notes	Serial # Range	Starter Solenoid	Power Trim Solenoid	Power Trim Relay
80	4 cylinder w/trim circuit breaker & fuse	USA 6030903 - 6432900	89- 96054T	89- 96158T	N/A
		AUS 8074612 and up			
		BEL 9345615 - 9393855			
		CAN 7189007 - 7208572			
80	3 cylinder	USA 0A996142 and up	89- 96158T	89- 96158T	N/A
		BEL 9483121 and up			
80 JET	4 cylinder	USA 0D283222 and up	89-817109A 2	N/A	N/A
80 JET	3 cylinder	USA 1B586067 and up	89-817109A 2	N/A	882751A 1
85 (850)	4 cylinder	USA 3493913 - 3865694	25661T 1	N/A	N/A
		AUS 8005440 - 8017139			
		BEL 9011604 - 9053363			
		CAN 7010108 - 7033027			
85 (850)	4 cylinder	USA 3865695 - 4831998	89-853654A 1	N/A	N/A
		AUS 8017140 - 8050199			
		BEL 9053364 - 9177625			
		CAN 7033028 - 7110997			
90 (90, 900)	6 cylinder	USA 4845301 - 5299505	89-853654A 1	89-853654A 1	N/A
		CAN 7111698 - 7123762			
90	6 cylinder	USA 5299506 - 5594656	89-853654A 1	89-853654A 1	N/A
		AUS 8060545 - 8060694			
90	6 cylinder wo/trim circuit breaker & fuse	USA 5594657 - 6026608	89-853654A 1	89-853654A 1	N/A
		AUS 8071020 - 8074512			
		CAN 7147088 - 7185072			
90	6 cylinder w/trim circuit breaker & fuse	USA 5594657 - 6026608	89-853654A 1	89- 96158T	N/A
		AUS 8071020 - 8074512			
		CAN 7147088 - 7185072			
90	6 cylinder wo/trim circuit breaker & fuse	USA 6026609 - 6436122	89- 96054T	89-853654A 1	N/A
		AUS 8074513 and up			
		CAN 7185073 - 7208847			
90	6 cylinder w/trim circuit breaker & fuse	USA 6026609 - 6436122	89- 96054T	89- 96158T	N/A
		AUS 8074513 and up			
		CAN 7185073 - 7208847			
90	6 cylinder	USA 6436123 and up	89- 96054T	89- 96158T	N/A
		CAN 7208848 and up			
90	3 cylinder	USA 0A996142 - 0C221999	89- 96158T	89- 96158T	N/A
		BEL 9483121 - 9589038			
90	3 cylinder w/3 Ram Trim	USA 0C222000 - 0D252460	89-850187T 1	89-850187T 1	N/A
		BEL 9589039 and up			
90	3 cylinder w/1 Ram Trim	USA 0C222000 - 0D252460	89-850187T 1	N/A	882751A 1
		BEL 9589039 and up			
90	3 cylinder w/1 Ram Trim	USA 0D252461 - 0D283221	89-850187T 1	89-818997T 1	N/A
		BEL			
90	3 cylinder	USA 0D283222 - 0G127499	89-850187T 1	89-818997T 1	N/A
		BEL 9793577 - 9836632			
90	3 cylinder	USA 0G127500 - 0G360002	89-817109A 2	89-818997T 1	N/A
		BEL 9836633 - 9934136			
90	3 cylinder	USA 0G360003 and up	89-817109A 2	N/A	882751A 1
		BEL 9934137 and up			
90 Optimax	3 cylinder, 1.5L	USA 0T801000 and up	89-817109A 2	N/A	882751A 1
100 (1000 SS)		2318586 - 2836018	25661T 1	N/A	N/A
100 (1000 BP)		2399698 - 3253111	25661T 1	N/A	N/A
100	4 cyl. w/ 3 Ram Trim & 5/16-18 starter terminal	USA 0B209468 - 0D252460	89-817109A 2	89-850187T 1	N/A(1)
		BEL 9523034 and up			

Model	Model Notes	Serial # Range	Starter Solenoid	Power Trim Solenoid	Power Trim Relay
100	4 cyl. w/ 1 Ram Trim & 5/16-18 starter terminal	USA 0B209468 - 0D252460 BEL 9523034 and up	89-817109A 2	N/A	882751A 1(1)
100	4 cylinder w/ 5/16-18 starter terminal	USA 0D252461 - 0D283221 BEL	89-817109A 2 89-817109A 2	89-818997T 1	N/A(1)
100	4 cylinder	USA 0D283222 - 0G359967 BEL 9793577 - 9934136	89-817109A 2	89-818997T 1	N/A
100	4 cylinder	USA 0G359968 and up BEL 9934137 and up	89-817109A 2	N/A	882751A 1
110 (1100)	6 cylinder	1870204 - 2314955	25661T 1	N/A	N/A
115 (1150)	6 cylinder	USA 2836019 - 4112634 AUS 8008665 - 8027114 CAN 7010763 - 7047257	25661T 1	25661T 1	N/A
115 (115, 1150)	6 cylinder	USA 4112635 - 5600966 AUS 8027115 - 8061269 CAN 7047258 - 7147987	89-853654A 1	89-853654A 1	N/A
115	6 cylinder wo/trim circuit breaker & fuse	USA 5600967 - 6051525 AUS 8061270 - 8071274 CAN 7147988 - 7186572	89-853654A 1	89-853654A 1	N/A
115	6 cylinder w/trim circuit breaker & fuse	USA 5600967 - 6051525 AUS 8061270 - 8071274 CAN 7147988 - 7186572	89-853654A 1	89-96158T	N/A
115	6 cylinder wo/trim circuit breaker & fuse	USA 6051526 - 6436122 CAN 7186573 - 7208847	89-96054T	89-96158T	N/A
115	6 cylinder w/trim circuit breaker & fuse	USA 6051526 - 6436122 CAN 7186573 - 7208847	89-96054T	89-96158T	N/A
115	6 cylinder	USA 6436123 and up CAN 7208848 and up	89-96054T	89-96158T	N/A
115	4 cyl. w/ 3 Ram Trim & 5/16-18 starter terminal	USA 0C100000 - 0D252460 BEL 9559771 and up	89-817109A 2	89-850187T 1	N/A(1)
115	4 cyl. w/ 1 Ram Trim & 5/16-18 starter terminal	USA 0C100000 - 0D252460 BEL 9559771 and up	89-817109A 2	N/A	882751A 1(1)
115	4 cylinder w/ 5/16-18 starter terminal	USA 0D252461 - 0D283221 BEL	89-817109A 2	89-818997T 1	N/A(1)
115	4 cylinder	USA 0D283222 - 0G359967 BEL 9793577 - 9934136	89-817109A 2	89-818997T 1	N/A
115	4 cylinder	USA 0G359968 and up	89-817109A 2	N/A	882751A 1
115	4 cylinder	BEL 9934137 and up	89-817109A 2	N/A	882751A 1
115 Optimax	3 cylinder, 1.5L	USA 0T801000 and up	89-817109A 2	N/A	882751A 1
115 Pro XS		USA 1B751825 and up	89-817109A 2	N/A	882751A 1
125 (1250, 1250 BP)	6 cylinder	2314956 - 3253111	25661T 1	N/A	N/A
125	4 cylinder	USA 0D283222 - 0G359967 BEL 9793577 - 9934136	89-817109A 2	89-818997T 1	N/A
125	4 cylinder	USA 0G359968 and up BEL 9934137 and up	89-817109A 2	N/A	882751A 1
125 Optimax	3 cylinder, 1.5L	USA 1B736885 and up	89-817109A 2	N/A	882751A 1
135 (1350)	6 cylinder	2839369 - 3293233	25661T 1	N/A	N/A
140 (1400)	6 cylinder	3293234 - 3502805	25661T 1	25661T 1	N/A
140 (140, 1400)	6 cylinder	USA 4865678 and up AUS 8052650 and up CAN 7112773 and up	89-853654A 1	89-853654A 1	N/A
140 JET		USA 0G303046 - 0T178499	89-817109A 2	N/A	882751A 1
150 (1500)	6 cylinder	USA 3502806 - 4121434 AUS 8005615 - 8028040 CAN 7010533 - 7048782	25661T 1	25661T 1	N/A

Not all parts listed are available for the European, C.I.S., Africa and Middle East Markets.  
For more information, please contact your local Mercury, Mariner, MerCruiser or Quicksilver Office.

# ELECTRICAL SYSTEM

Model	Model Notes	Serial # Range	Starter Solenoid	Power Trim Solenoid	Power Trim Relay
150 (1500)	6 cylinder	USA 4121435 - 4865677	89-853654A 1	25661T 1	N/A
		AUS 8028041 - 8052649			
		CAN 7048783 - 7112772			
150 (1500XS)		USA 4868648 - 5327662	89-853654A 1	89-853654A 1	N/A
105 JET	V-6 w/flush mounted starter solenoid	USA 0D082000 - 0G303045	89-853654A 1	N/A	N/A
105 JET	V-6 w/rubber mounted starter solenoid	USA 0D082000 - 0G303045	89-817109A 2	N/A	N/A
105 JET	V-6	USA 0G303046 and up	89-817109A 2	N/A	N/A
V-135	w/1/4-20 starter solenoid terminals	USA 0A904646 - 0C100860	89- 96054T	89- 96158T	N/A
V-135	w/5/16-18 starter solenoid terminals	USA 0A904646 - 0C100860	89-853654A 1	89- 96158T	N/A
V-135		USA 0C100861 - 0C239552	89-853654A 1	89- 96158T	N/A
V-135	w/standard color trim solenoid	USA 0C239553 - 0D081999	89-853654A 1	89- 96158T	N/A
V-135	w/off white color trim solenoid	USA 0C239553 - 0D081999	89-853654A 1	89-818864T	N/A
V-135	w/flush mounted starter solenoid	USA 0D082000 - 0G201874	89-853654A 1	89-818997T 1	N/A
V-135	w/rubber bushing mount starter solenoid	USA 0D082000 - 0G201874	89-817109A 2	89-818997T 1	N/A
V-135	w/flush mounted starter solenoid	USA 0G201875 - 0G303045	89-853654A 1	N/A	882751A 1
V-135	w/rubber bushing mount starter solenoid	USA 0G201875 - 0G303045	89-817109A 2	N/A	882751A 1
V-135		USA 0G303046 and up	89-817109A 2	N/A	882751A 1
V-135 DFI		USA 0G590000 and up	89-817109A 2	N/A	882751A 1
V-150 Mercury		USA 5432022 - 6042945	89-853654A 1	89- 96158T	N/A
V-150 Mariner		USA 5432022 - 6038680	89-853654A 1	89- 96158T	N/A
V-150 Mercury		USA 6042946 - 0A904645	89- 96054T	89- 96158T	N/A
V-150 Mariner		USA 6038681 - 0A904645	89- 96054T	89- 96158T	N/A
V-150	w/1/4-20 starter solenoid terminals	USA 0A904646 - 0C100860	89- 96054T	89- 96158T	N/A
V-150	w/5/16-18 starter solenoid terminals	USA 0A904646 - 0C100860	89-853654A 1	89- 96158T	N/A
V-150		USA 0C100861 - 0C239552	89-853654A 1	89- 96158T	N/A
V-150	w/standard color trim solenoid	USA 0C239553 - 0D081999	89-853654A 1	89- 96158T	N/A
V-150	w/off white color trim solenoid	USA 0C239553 - 0D081999	89-853654A 1	89-818864T	N/A
V-150	w/flush mounted starter solenoid	USA 0D082000 - 0G201874	89-853654A 1	89-818997T 1	N/A
V-150	w/rubber bushing mount starter solenoid	USA 0D082000 - 0G201874	89-817109A 2	89-818997T 1	N/A
V-150	w/flush mounted starter solenoid	USA 0G201875 - 0G303045	89-853654A 1	N/A	882751A 1
V-150	w/rubber bushing mount starter solenoid	USA 0G201875 - 0G303045	89-817109A 2	N/A	882751A 1
V-150		USA 0G303046 and up	89-817109A 2	N/A	882751A 1
V-150 EFI	w/flush mounted starter solenoid	USA 0D082000 - 0G201874	89-853654A 1	89-818997T 1	N/A
V-150 EFI	w/rubber bushing mount starter solenoid	USA 0D082000 - 0G201874	89-817109A 2	89-818997T 1	N/A
V-150 EFI	w/flush mounted starter solenoid	USA 0G201875 - 0G303045	89-853654A 1	N/A	882751A 1
V-150 EFI	w/rubber bushing mount starter solenoid	USA 0G201875 - 0G303045	89-817109A 2	N/A	882751A 1
V-150 EFI		USA 0G303046 and up	89-817109A 2	N/A	882751A 1
V-150 DFI		USA 0G590000 and up	89-817109A 2	N/A	882751A 1
V-150 XR4		USA 0B242885 - 0C239552	89-853654A 1	89- 96158T	N/A
V-150 XR4	w/standard color trim solenoid	USA 0C239553 - 0D081999	89-853654A 1	89- 96158T	N/A
V-150 XR4	w/off white color trim solenoid	USA 0C239553 - 0D081999	89-853654A 1	89-818864T	N/A
V-150 XR6	w/flush mounted starter solenoid	USA 0D082000 - 0G201874	89-853654A 1	89-818997T 1	N/A
V-150 XR6	w/rubber bushing mount starter solenoid	USA 0D082000 - 0G201874	89-817109A 2	89-818997T 1	N/A
V-150 XR6	w/flush mounted starter solenoid	USA 0G201875 - 0G303045	89-853654A 1	N/A	882751A 1
V-150 XR6	w/rubber bushing mount starter solenoid	USA 0G201875 - 0G303045	89-817109A 2	N/A	882751A 1
V-150 XR6		USA 0G303046 and up	89-817109A 2	N/A	882751A 1
V-175 (V-175, V-1750)		USA 4301235 - 6618750	89-853654A 1	89-853654A 1	N/A
		AUS 8058870 and up			
V-175	w/1/4-20 starter solenoid terminals	USA 6618751 - 0C100860	89- 96054T	89- 96158T	N/A
V-175	w/5/16-18 starter solenoid terminals	USA 6618751 - 0C100860	89-853654A 1	89- 96158T	N/A
V-175		USA 0C100861 - 0C239552	89-853654A 1	89- 96158T	N/A
V-175	w/standard color trim solenoid	USA 0C239553 - 0D081999	89-853654A 1	89- 96158T	N/A
V-175	w/off white color trim solenoid	USA 0C239553 - 0D081999	89-853654A 1	89-818864T	N/A



# ELECTRICAL SYSTEM

Model	Model Notes	Serial # Range	Starter Solenoid	Power Trim Solenoid	Power Trim Relay
V-175	w/flush mounted starter solenoid	USA 0D082000 - 0G201874	89-853654A 1	89-818997T 1	N/A
V-175	w/rubber bushing mount starter solenoid	USA 0D082000 - 0G201874	89-817109A 2	89-818997T 1	N/A
V-175	w/flush mounted starter solenoid	USA 0G201875 - 0G303045	89-853654A 1	N/A	882751A 1
V-175	w/rubber bushing mount starter solenoid	USA 0G201875 - 0G303045	89-817109A 2	N/A	882751A 1
V-175		USA 0G303046 and up	89-817109A 2	N/A	882751A 1
V-175 EFI	w/standard color trim solenoid	USA 0D000750 - 0D081999	89-853654A 1	89-96158T	N/A
V-175 EFI	w/off white color trim solenoid	USA 0D000750 - 0D081999	89-853654A 1	89-818864T	N/A
V-175 EFI	w/flush mounted starter solenoid	USA 0D082000 - 0G201874	89-853654A 1	89-818997T 1	N/A
V-175 EFI	w/rubber bushing mount starter solenoid	USA 0D082000 - 0G201874	89-817109A 2	89-818997T 1	N/A
V-175 EFI	w/flush mounted starter solenoid	USA 0G201875 - 0G303045	89-853654A 1	N/A	882751A 1
V-175 EFI	w/rubber bushing mount starter solenoid	USA 0G201875 - 0G303045	89-817109A 2	N/A	882751A 1
V-175 EFI		USA 0G303046 - 0T800999	89-817109A 2	N/A	882751A 1
V-175 DFI		USA 0G960500 and up	89-817109A 2	N/A	882751A 1
V-175 Pro XS		USA 1B516339 and up	89-817109A 2	N/A	882751A 1
V-200 (V-200, V-2000)		USA 4839034 - 6073191	89-853654A 1	89-853654A 1	N/A
		AUS 8061595 - 8065672			
V-200		USA 6073192 - 6625220	89-96054T	89-96158T	N/A
V-200	w/1/4-20 starter solenoid terminals	USA 6625221 - 0C100860	89-96054T	89-96158T	N/A
V-200	w/5/16-18 starter solenoid terminals	USA 6625221 - 0C100860	89-853654A 1	89-96158T	N/A
V-200		USA 0C100861 - 0C291519	89-853654A 1	89-96158T	N/A
V-200 (2.5L)	w/standard color trim solenoid	USA 0C291520 - 0D081999	89-853654A 1	89-96158T	N/A
V-200 (2.5L)	w/off white color trim solenoid	USA 0C291520 - 0D081999	89-853654A 1	89-818864T	N/A
V-200	w/flush mounted starter solenoid	USA 0D082000 - 0G201874	89-853654A 1	89-818997T 1	N/A
V-200	w/rubber bushing mount starter solenoid	USA 0D082000 - 0G201874	89-817109A 2	89-818997T 1	N/A
V-200	w/flush mounted starter solenoid	USA 0G201875 - 0G303045	89-853654A 1	N/A	882751A 1
V-200	w/rubber bushing mount starter solenoid	USA 0G201875 - 0G303045	89-817109A 2	N/A	882751A 1
V-200		USA 0G303046 and up	89-817109A 2	N/A	882751A 1
V-200 EFI (2.4L)		USA 0C100861 - 0C291519	89-853654A 1	89-96158T	N/A
V-200 EFI (2.5L)	w/standard color trim solenoid	USA 0C291520 - 0D081999	89-853654A 1	89-96158T	N/A
V-200 EFI (2.5L)	w/off white color trim solenoid	USA 0C291520 - 0D081999	89-853654A 1	89-818864T	N/A
V-200 EFI	w/flush mounted starter solenoid	USA 0D082000 - 0G201874	89-853654A 1	89-818997T 1	N/A
V-200 EFI	w/rubber bushing mount starter solenoid	USA 0D082000 - 0G201874	89-817109A 2	89-818997T 1	N/A
V-200 EFI	w/flush mounted starter solenoid	USA 0G201875 - 0G303045	89-853654A 1	N/A	882751A 1
V-200 EFI	w/rubber bushing mount starter solenoid	USA 0G201875 - 0G303045	89-817109A 2	N/A	882751A 1
V-200 EFI		USA 0G303046 and up	89-817109A 2	N/A	882751A 1
V-200 DFI (3.0L)		USA 0G386496 and up	89-817109A 2	N/A	882751A 1
V-200 Pro XS		USA 1B504989 and up	89-817109A 2	N/A	882751A 1
V-220 Laser		USA 0B117316 and up	89-853654A 1	89-96158T	N/A
V-225 (2.4L)		USA 5628028 and up	89-853654A 1	89-853654A 1	N/A
V-225 (3.0L)		USA 0D280813 - 0G129221	89-817109A 2	89-818997T 1	N/A
V-225 (3.0L)	w/trim solenoids	USA 0G129222 - 0G303045	89-817109A 2	89-818997T 1	N/A
	w/trim relays	USA 0G129222 - 0G303045	89-817109A 2	N/A	882751A 1
V-225 (3.0L)		USA 0G303046 and up	89-817109A 2	N/A	882751A 1
V-225 Sea Pro/Marathon		USA 0G245605 and up	89-817109A 2	N/A	882751A 1
V-225 DFI		USA 0G590000 and up	89-817109A 2	N/A	882751A 1
V-225 Pro XS		USA 1B104549 and up	89-817109A 2	N/A	882751A 1
V-225/250 EFI		USA 0G129222 and up	89-817109A 2	N/A	882751A 1
V-250XB		USA 0G980600 and up	89-817109A 2	N/A	882751A 1
V-250 Pro XS		USA 1B426561 and up	89-817109A 2	N/A	882751A 1
V-250/275 (3.4L)		USA 0C101891 and up	89-853654A 1	89-96158T	N/A
V-300 (3.4L)		USA 5611648 and up	89-853654A 1	89-96158T	N/A

(1) 1/4-20 starter solenoid terminals require an 818998A 1 solenoid

## ELECTRICAL HARNESS REPAIR COMPONENTS

### ALTERNATOR HARNESS SERVICE END



#### 84-856624A 2

As an alternative to replacing the complete engine harness, this service end is furnished with the necessary bullet connector to connect to the main engine harness.

OptiMax model year 2000 and prior, Nippondenso alternators only.

### ALTERNATOR HARNESS SERVICE END



#### 84-881262A 2

As an alternative to replacing the complete engine harness, this service end is furnished with the necessary bullet connector to connect to the main engine harness.

OptiMax model year 1998 thru 2001, Delco alternator only.

### CAN 1 HARNESS REPAIR KIT

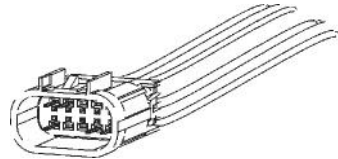

#### 879346A31

Use when the replacement of an entire harness is not necessary. Includes the 10 pin connector and 5 crimp splices.

Fits the 75-115hp. EFI FourStroke outboard (1B366823-2B094995) the Optimax outboard and the L4/L6 Verado outboards. Also fits MCM CAN 1 resistors.

### PACKARD REPAIR KIT, 2 PIN BLACK

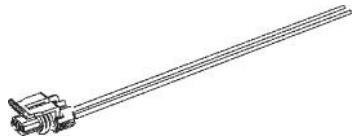

#### 879346A32

Use when the replacement of an entire harness is not necessary. Includes the Packard 2-pin connector and 2 crimp splices.

Fits the 75-115hp. EFI FourStroke outboard (1B366823-2B094995)(temp sensors, vent canister switch and purge valve, neutral switch, trim relay harness), the Optimax outboard (neutral switch, temp sensors, IVST fuel pump, CAN 2 terminator) and the L4/L6 Verado (temp sensors, vent canister switch, vent vanister purge valve, knock resistor, neutral switch, water in fuel sensor, CAN 2 terminator). Also fits MCM 3.0L TKS temp switch, 3.0L MPI fuel pump, V-6 & SB V-8 exhaust water temp and 8.2L digital coolant sensor.

### KNOCK SENSOR REPAIR KIT, 2-PIN, WHITE



#### 879346A33

Use when the replacement of an entire harness is not necessary. Includes the Packard 2-pin connector and 2 crimp splices.

Fits the L4/L6 Verado outboards. Also fits current MCM V-6 & V-8 knock sensors.

### PACKARD REPAIR KIT, 3-PIN, BLACK

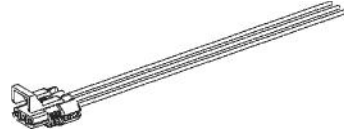

#### 879346A34

Use when the replacement of an entire harness is not necessary. Includes the Packard 3-pin connector and 3 crimp splices.

Fits the L4/L6 Verado outboards (trim relay harness, power steering). Also fits MCM V-6 & SB V-8 cam position sensor.

### PACKARD REPAIR KIT, 3-PIN GRAY

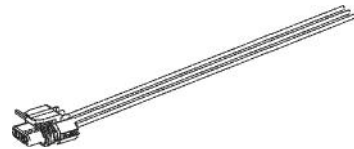

#### 879346A35

Use when the replacement of an entire harness is not necessary. Includes the Packard 3-pin connector and 3 crimp splices.

Fits the 75-115hp. EFI FourStroke outboard (1B366823-2B094995)(MAP sensor) and the Optimax outboard (MAP Sensor). Also fits current MCM 8.2L MAP sensor.

### PACKARD REPAIR KIT, 4-PIN



#### 879346A36

Use when the replacement of an entire harness is not necessary. Includes the Packard 4-pin connector and 4 crimp splices.

Fits the 75-115hp. EFI FourStroke outboard (1B366823-2B094995)(diagnostics connector), the Optimax outboard (diagnostics connector) and the L4/L6 Verado outboards (diagnostics connector). Also fits MCM diagnostic/depth finder connector.

### PACKARD REPAIR KIT, 5-PIN

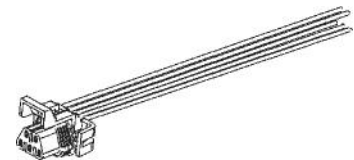

#### 879346A37

Use when the replacement of an entire harness is not necessary. Includes the Packard 5-pin connector and 5 crimp splices.

Fits Optimax outboard (shift actuator) and the L4/L6 Verado outboard (shift actuator). Also fits MCM DTS digital shift actuator.

**PACKARD REPAIR KIT, 6-PIN**

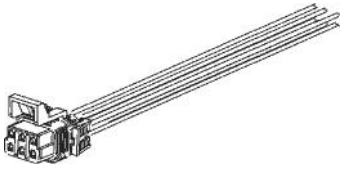

**879346A38**

Use when the replacement of an entire harness is not necessary. Includes the Packard 6-pin connector and 6 crimp splices.  
 Fits the 75-115hp. EFI FourStroke outboard (1B366823-2B094995)(SmartCraft boat harness, FSM harness), the Optimax outboard (SmartCraft boat harness) and the L4/L6 Verado outboard (SmartCraft boat harness, FSM harness). Also fits MCM paddle/fuel connector.

**PACKARD REPAIR KIT, 3-PIN, ROUND**

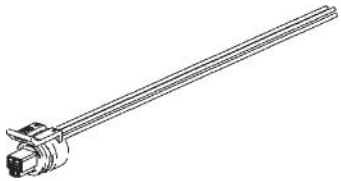

**879346A39**

Use when the replacement of an entire harness is not necessary. Includes the Packard 3-pin connector and 3 crimp splices.  
 Fits the 75-115hp. EFI FourStroke outboard (1B366823-2B094995)(MAP, pitot pressure, block water pressure, oil pressure, TPS throttle position), the Optimax outboard (block water pressure, pitot pressure) and the L4/L6 Verado outboard (MAP, pitot pressure, oil pressure, block pressure, 350SCi fuel rail pressure sensors). Also fits MCM V-6 & V-8 digital oil pressure sensor and 3.0L MPI TPS.

**IGNITION COIL DRIVER REPAIR KIT, 2-PIN**

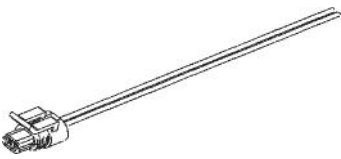

**879346A40**

Use when the replacement of an entire harness is not necessary. Includes the 2-pin connector and 2 crimp splices.  
 Fits the Optimax outboard (ignition coil driver). Also fits MCM digital coolant sensor.

**DELPHI REPAIR KIT, 3-PIN**

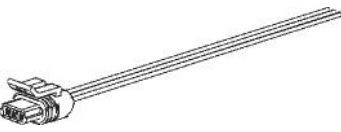

**879346A41**

Use when the replacement of an entire harness is not necessary. Includes the 3-pin connector and 3 crimp splices.  
 Fits the 75-115hp. EFI FourStroke outboard (1B366823-2B094995)(cam position sensor), the Optimax outboard (ignition coil, throttle position sensor) and the L4/L6 Verado outboard (cam position sensor). Also fits MCM 8.2L cam position sensor.

**DELPHI REPAIR KIT, 4-PIN**

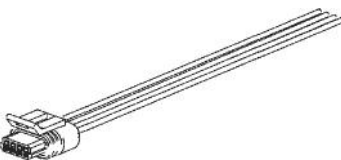

**879346A42**

Use when the replacement of an entire harness is not necessary. Includes the 4-pin connector and 4 crimp splices.  
 Fits the Optimax outboard (ignition coil driver). Also fits MCM V-6 & SB V-8 ignition coil driver.

**BOOST VALVE REPAIR KIT, 4-PIN**

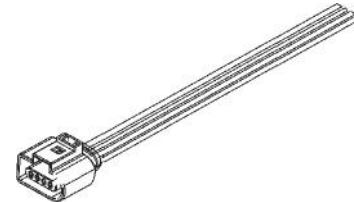

**879346A43**

Use when the replacement of an entire harness is not necessary. Includes the 4-pin connector and 4 crimp splices.  
 Fits the L4/L6 Verado outboards (boost valve).

**ETC ELECTRONIC THROTTLE REPAIR KIT, 6-PIN**

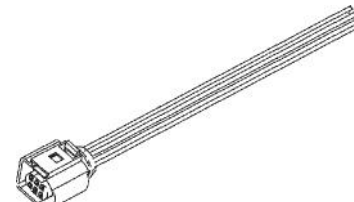

**879346A44**

Use when the replacement of an entire harness is not necessary. Includes the 6-pin connector and 6 crimp splices.  
 Fits the Optimax outboard (ETC electronic throttle control) and the L4/L6 Verado outboard (ETC electronic throttle control). Also fits MCM DTS digital throttle.

**MAT MANIFOLD AIR TEMPERATURE REPAIR KIT, 2-PIN**

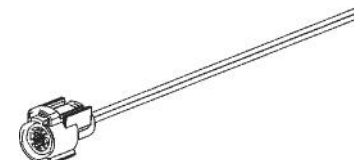

**879346A45**

Use when the replacement of an entire harness is not necessary. Includes the MAT 2-pin connector and 2 crimp splices.  
 Fits the 75-115hp. EFI FourStroke outboard (1B366823-2B094995)(MAT sensor) and the L4/L6 Verado outboard (MAT sensor).

**PENCIL COIL REPAIR KIT, 3-PIN**

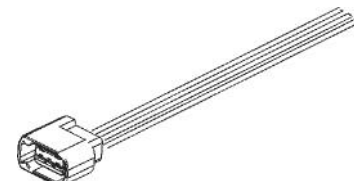

**879346A46**

Use when the replacement of an entire harness is not necessary. Includes the 3-pin connector and 3 crimp splices.  
 Fits the 75-115hp. EFI FourStroke outboard (1B366823-2B094995)(pencil coil) and the L4/L6 Verado outboard (pencil coil).

## ELECTRICAL SYSTEM

### HARNESS REPAIR KIT, 3-PIN

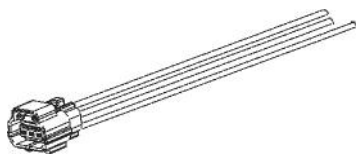

**879346A47**

Use when the replacement of an entire harness is not necessary. Includes the cowl switch connector and 3 crimp splices.

Fits the 75-115hp. EFI FourStroke outboard (1B366823-2B094995)(cowl tilt switch), the Optimax outboard (cowl tilt switch) and the L4/L6 Verado outboard (cowl tilt switch, trim sensor harness).

### RELAY BASE REPAIR KIT, WHITE

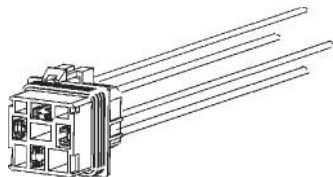

**879346A48**

Use when the replacement of an entire harness is not necessary. Includes the relay base connector and 4 crimp splices.

Fits the 75-115hp. EFI FourStroke outboard (1B366823-2B094995)(main power relay), the Optimax outboard (main power relay) and the L4/L6 Verado outboard (fuel pump relay, starter relay). Also fits MCM starter relay and main power relay.

### DIRECT INJECTOR HARNESS SERVICE END

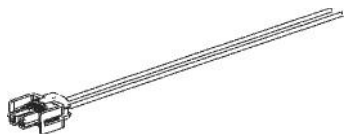

**879346A49**

As an alternative to replacing the complete engine harness, this service end is furnished with the necessary 2 bullet connectors to connect to the main engine harness.

Fits the Optimax outboard (direct injector).

### FUEL INJECTOR HARNESS SERVICE END

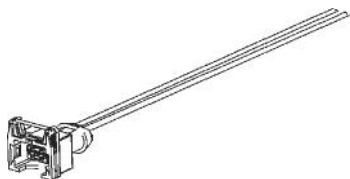

**879346A50**

As an alternative to replacing the complete engine harness, this service end is furnished with the necessary 2 bullet connectors to connect to the main engine harness.

Fits the 75-115hp. EFI FourStroke outboard (1B366823-2B094995)(fuel injector), the Optimax outboard (fuel injector) and the L4/L6 Verado outboard (fuel injector). Also fits the current 8.2L injectors.

### IGNITION COIL REPAIR KIT, 5-PIN

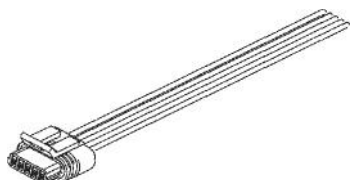

**879346A51**

Use when the replacement of an entire harness is not necessary. Includes the 5-pin connector and 5 crimp splices.

Fits the Optimax outboard (ignition coil).

### CPS CRANKSHAFT POSITION SENSOR REPAIR KIT, 2-PIN

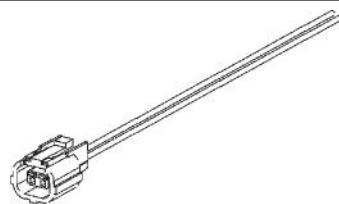

**879346A52**

Use when the replacement of an entire harness is not necessary. Includes the CPS 2-pin connector and 2 crimp splices.

Fits the 75-115hp. EFI FourStroke outboard (1B366823-2B094995)(crankshaft position sensor), the Optimax outboard (crankshaft position sensor) and the L4/L6 Verado outboard (crankshaft position sensor). Also fits the 3.0L MPI crankshaft position sensor.

### ALTERNATOR REPAIR KIT, 2-PIN

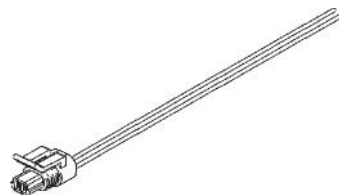

**879346A53**

Use when the replacement of an entire harness is not necessary. Includes the alternator 2-pin connector and 2 crimp splices.

Fits the 75-115hp. EFI FourStroke outboard (1B366823-2B094995), the Optimax outboard and the L4/L6 Verado outboard.

### IAC REPAIR KIT, 2-PIN



**8M0050085**

As an alternative to replacing the complete engine harness, this service end is furnished with the necessary 2 bullet connectors to connect to the main engine harness.

Fits the 75-115hp. EFI FourStroke outboard (1B366823-2B094995)(Idle air control IAC).

### DTS POWER HARNESS REPAIR KIT, 2-PIN

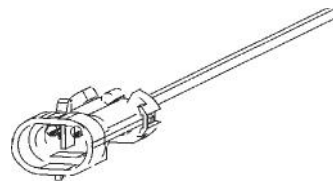

**8M0050324**

As an alternative to replacing the complete engine harness, this service end is furnished with the necessary 2 bullet connectors to connect to the main engine harness.

Fits the Optimax outboard (DTS power harness).

**CRANK SENSOR HARNESS SERVICE END****84-878074A 2**

As an alternative to replacing the complete engine harness, this service end is furnished with the necessary bullet connector to connect to the main engine harness.

OptiMax model year 2000 and prior.

**ELECTRICAL HARNESS SEAL KIT**

Electrical harness seals found in a variety of Optimax, DFI and EFI applications may be purchased in kit form or ordered separately.

**HARNESS SEAL KIT****91-881814A 1**

Harness seals located in a convenient trayed plastic container. Separate seals may be purchased individually to replenish your inventory needs. Seal part numbers can be found on the inside of the kit's cover. The basic kit starts you out with 6 each of 14 different seals.

Used to provide effective seal to electrical harness connections on Mercury/Mariner OptiMax, DFI and EFI outboards.

**IGNITION COIL HARNESS SEAL****26-878461 3**

Green, 3-way.

Priced individually, sold @ multiples of 2

**MAP SENSOR HARNESS SEAL****26-878463 3**

Purple, 3-way.

Priced individually, sold @ multiples of 2

**CDM HARNESS SEAL****26-878461 4**

Light blue, 4-way.

Priced individually, sold @ multiples of 2

**TEMPERATURE SENDER HARNESS SEAL****26-878463 2**

Gray, 2-way.

Priced individually, sold @ multiples of 2

**DDT HARNESS SEAL****26-878466**

Green, 2-way.

Priced individually, sold @ multiples of 2

# ELECTRICAL SYSTEM

## OIL PUMP HARNESS SEAL



**26-878461 2**

Light Blue, 2-way.  
Priced individually, sold @ multiples of 2

## DIRECT INJECTOR HARNESS SEAL



**26-878462**

Light Blue, 2-way.  
Priced individually, sold @ multiples of 2

## FUEL PUMP HARNESS SEAL



**26-878464 2**

Green, 2-way.  
Priced individually, sold @ multiples of 2

## RELAY HARNESS SEAL



**26-878465**

Green, 5-way.  
Priced individually, sold @ multiples of 2

## FUSE HARNESS SEAL



**26-878464 6**

Green, 6-way.  
Priced individually, sold @ multiples of 2

## FUSE HARNESS SEAL



**26-878464 8**

Green, 8-way.  
Priced individually, sold @ multiples of 2

## SS-V6 HARNESS SEAL



**26-878463 6**

Light Blue, 6-way.  
Priced individually, sold @ multiples of 2

## STATOR HARNESS SEAL



**26-878463 4**

Tan, 4-way.  
Priced individually, sold @ multiples of 2

FUEL SYSTEM

CHECK VALVE KITS

CHECK VALVE KIT



21- 30430A 2

CHECK VALVE KIT



21-8M0084275

Kit contains fuel pump diaphragms, gaskets, check valves, spring, cap and screws. Filler blocks are no longer available.

CHECK VALVE KIT

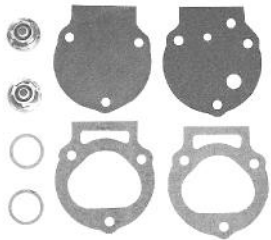

21- 30430A 1

CHECK VALVE KIT



21- 30430A 3

CHECK VALVE KIT



21-8M0084276

Kit contains fuel pump diaphragms, gaskets, check valves, spring, cap and screws. Filler blocks are no longer available.

CHECK VALVE KIT



21- 30430A 7

CHECK VALVE KIT



21-8M0084277

Kit contains fuel pump diaphragms, gaskets, check valves, inlet screen, pulse chamber, spring, cap and screws. Filler blocks are no longer available.

CHECK VALVE KIT



21- 30430A 8

# FUEL SYSTEM

## FUEL PUMP DIAPHRAGM KITS

### FUEL PUMP DIAPHRAGM



80606M

### FUEL PUMP DIAPHRAGM

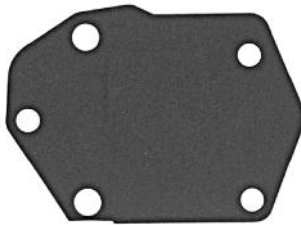

84141M

### GASKET



27-98769 1

### DIAPHRAGM KIT



31503A 1

Priced individually, sold @ multiples of 5

### DIAPHRAGM & GASKET KIT



1395-9761 1

### DIAPHRAGM KIT

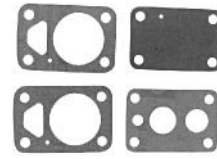

53245A 1

### DIAPHRAGM KIT

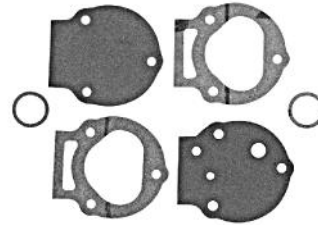

23014A 1

### DIAPHRAGM KIT



21-857005A 1

### DIAPHRAGM KIT



55278A 1

### DIAPHRAGM KIT



55278A 4

Priced individually, sold @ multiples of 5



DIAPHRAGM KIT

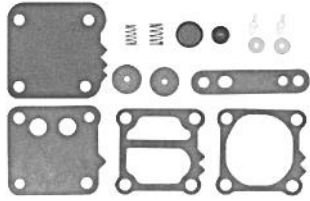

42909A 4

DIAPHRAGM KIT



55278A 5

DIAPHRAGM KIT



89031A 1

Priced individually, sold @ multiples of 2

DIAPHRAGM KIT

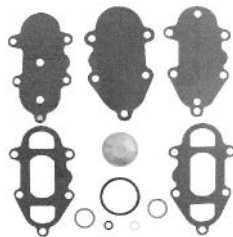

89031A 3

Priced individually, sold @ multiples of 2

DIAPHRAGM KIT



89031A 2

Priced individually, sold @ multiples of 2

DIAPHRAGM KIT



90363A 1

DIAPHRAGM KIT



89031A 4

MECHANICAL FUEL PUMP ASSEMBLY



835389T02

Sold as a complete assembly.  
Fits the F8/9.9/13.5/15 Hp. FourStroke 323cc. outboards.

# FUEL SYSTEM

## DIAPHRAM KIT



21-851812A01

## FUEL PUMP ASSEMBLY



899106T01

Sold as complete pump only.

Fits the 40 hp. FourStroke (3 cylinder Carb model) s/n USA 1B036614-1B344306 and CHN 1C000001 and above, 40 hp. FourStroke (3 cylinder EFI model) s/n USA 0T409000 and above and CHN 1C000001 and above, and the 40/50/60 hp. (4 cylinder EFI model) s/n USA 0T409000 and above and CHN 1C000001 and above.

## MECHANICAL FUEL PUMP REPAIR CHART

### Mercury/Mariner Fuel Pump Repair Kits

Model	Serial # Range	Check Valve Kit	Diaphragm Kit	Mechanical Fuel Pump
3.9	1655013 - 2498135	N.L.A.	31503A 1	N.L.A.
4 (40)(1 cyl)	USA 2498136 - 4107219	21- 30430A 2	53245A 1	89977A 1
	AUS 3306257 - 8026539			
	BEL 9000306 - 90721718			
	CAN 3305152 - 7045757			
4 FourStroke	JPN 0R036272 and up	N/A	21-851812A01	803529T06
	BEL 0P401000 and up			
4.5 (45, 4.5)(1 cyl)	USA 4107220 - 5270783	21- 30430A 2	53245A 1	89977A 1
	AUS 8026540 - 8059344			
	BEL 9072179 - 9221755			
	CAN 7045758 - 7128837			
5 FourStroke	JPN 0R036272 and up	N/A	21-851812A01	803529T06
	BEL 0P401000 and up			
6 (60)	1916139 - 2529894	N.L.A.	31503A 1	N.L.A.
6 (60J)	2385673 - 2387383	N.L.A.	31503A 1	N.L.A.
6	USA 0A197112 - 0T800749	N/A	1395- 9761 1	N/A
	BEL 9461526 and up			
6 FourStroke	JPN 0R036272 and up	N/A	21-851812A01	803529T06
	BEL 0P401000 and up			
7.5 (75)	2529895 - 3488152	21- 30430A 2	53245A 1	89977A 1
8	USA 0A197112 and up	N/A	1395- 9761 1	N/A
	BEL 9461526 and up			
9.8 (110)	1865779 - 27980563	N.L.A.	31503A 1	N.L.A.
9.8 (110)	2798057 - 3795657	21- 30430A 2	53245A 1	89977A 1
9.9	USA 0A197112 and up	N/A	1395- 9761 1	N/A
	BEL 9461526 and up			
9.9 FourStroke 232cc	USA 0H000058 - 0H016909	N/A	N/A	N.L.A.
9.9 FourStroke 323cc	USA 0G760300 - 1B226999	N/A	N/A	835389T02
	BEL 0P075166 - 0P400999			
9.9 FourStroke	JPN 0R042475 and up	N/A	21-851812A01	803529T06
	BEL 0P325500 and up			
15	USA 0B292414 and up	N/A	1395- 9761 1	N/A
	BEL 9542620 and up			
15 FourStroke	USA 0G590000 - 1B727495	N/A	N/A	835389T02

Model	Serial # Range	Check Valve Kit	Diaphragm Kit	Mechanical Fuel Pump
15 FourStroke	JPN 0R235949 and up	N/A	N/A	803529T04
20 (200)	1866496 - 2296266	21- 30430A 2	23014A 1	N.L.A.
20 (200)	2296267 - 2551114	N.L.A.	N.L.A.	N.L.A.
20 (200)	2551115 - 3537530	21- 30430A 2	53245A 1	89977A 1
20	USA 6443973 - 0T800749	N/A	1395- 9761 1	N/A
	BEL 9415101 and up			
	CAN 7209533 and up			
20 FourStroke	JPN 0R235168 and up	N/A	N/A	803529T04
20 JET	USA 0G044027 and up	N/A	1395- 9761 1	N/A
25	USA 6443973 and up	N/A	1395- 9761 1	N/A
	BEL 9415101 and up			
	CAN 7209533 and up			
25 FourStroke (Carb)	USA 0G590000 - 0T40899	N/A	N/A	826398T 3
	BEL 9973100 - 0P153499			
25 FourStroke (Carb)	USA 0T409000 - 1B344298	N/A	N/A	899106T
	BEL 0P153500 - 0P388282			
25 FourStroke (EFI)	JPN 0R106999 and up	N/A	N/A	803529T04
30 (2 cyl)(644cc)	0G053314 - 0T800749	N/A	21-857005A 1	14360A78
30 JET	0C159200 - 0T408999	N/A	21-857005A 1	14360A78
30 FourStroke	USA 0G760300 - 0T408999	N/A	N/A	826398T 3
	BEL 0P017000 - 0P153499			
30 FourStroke	USA 0T409000 - 1B226999	N/A	N/A	899106T
	BEL 0P153500 - 0P400999			
30 FourStroke	JPN 0R106999 and up	N/A	N/A	803529T04
35 (350)	1960827 - 2874703	21- 30430A 1	23014A 1	N.L.A.
35	USA 6445653 - 0B110788	21-8M0084275	55278A 4	N.L.A.
	BEL 9384476 - 9466646			
	CAN 7209608 and up			
35	USA 0B110789 and up	N/A	21-857005A 1	14360A78
	BEL 9466647 and up			
40 (40, 400, 402)(2 cyl)	USA 2874704 - 5556229	21- 30430A 3	55278A 1	N.L.A.
	AUS 8002335 - 8064749			
	BEL 3339688 - 9251455			
	CAN 3340783 - 7144762			
40 (2 cyl)(644cc)	USA 0G053314 and up	N/A	21-857005A 1	14360A78
40 (4 cyl)	USA 0C159200 and up	N/A	21-857005A 1	14360A78
	BEL 9570790 and up			
40 (3 cyl)	USA 0G590000 - 0T999999	N/A	21-857005A 1	14360A78
	BEL 9973100 and up			
40 FourStroke (3 cyl., Carb)	USA 0T409000 - 1B036613	N/A	899106T01	899106T
40 FourStroke (3 cyl., Carb)	USA 1B036614 - 1B344306	N/A	N/A	899106T01
	CHN 1C000001 and up			
40 FourStroke (3 cyl., EFI)	USA 0T409000 - 1B344398	N/A	N/A	899106T01
	BEL 0P153500 - 0P515896			
	CHN 1C000001 and up			
40 FourStroke (4 cyl., Carb)	USA 0T178500 - 0T598999	N/A	N/A	826398T 3
	BEL 0P094500 - 0P206999			
40 FourStroke (4 cyl., EFI)	USA 0T409000 - 1B344306	N/A	N/A	899106T01
	BEL 0P153500 and up			
	CHN 1C000001 and up			
40 JET (2 cycle)	USA 0G760300 and up	N/A	21-857005A 1	14360A78
	BEL 0P017000 and up			
40 FourStroke JET	CHN 1C051324 and up	N/A	N/A	899106T01

Not all parts listed are available for the European, C.I.S., Africa and Middle East Markets.  
 For more information, please contact your local Mercury, Mariner, MerCruiser or Quicksilver Office.

# FUEL SYSTEM

Model	Serial # Range	Check Valve Kit	Diaphragm Kit	Mechanical Fuel Pump
45 (4 cyl)	USA 0B110789 and up	N/A	21-857005A 1	14360A78
	BEL 9466692 and up			
45 JET	USA 0D000750 - 0T129554	N/A	21-857005A 1	14360A78
	BEL 9683055 - 0P094499			
50 (50, 500)(4 cyl)	USA 2116318 - 4357639	21- 30430A 2	23014A 1	N.L.A.
	AUS 2863739 - 8030089			
	BEL 9001581 - 9107213			
	CAN 2097445 - 7068997			
50 (3 cyl)	USA 6428681 - 0B122929	N/A	55278A 1	N.L.A.
	BEL 9385911 - 9469199			
	CAN 7208333 - 0A721307			
50 (3 cyl)	USA 0B122930 - 0T999999	N/A	21-857005A 1	14360A78
	BEL 9469200 and up			
	CAN 0A721308 and up			
50 FourStroke (Carb)	USA 0G231123 - 0T598999	N/A	N/A	826398T 3
	BEL 9944807 - 0P206999			
50 FourStroke (EFI)	USA 0T409000 - 1B226999	N/A	N/A	899106T01
	BEL 0P153500 - 0P400999			
	CHN 1C000001 and up			
55 (3 cyl)	USA 0D000750 and up	N/A	21-857005A 1	14360A78
	BEL 9741042 and up			
60 (3 cyl)	USA 6428681 - 0B122929	N/A	55278A 1	N.L.A.
	BEL 9385911 - 9469199			
	CAN 7208333 - 0A721307			
60 (3 cyl)	USA 0B122930 and up	N/A	21-857005A 1	14360A78
	BEL 9469200 and up			
	CAN 0A721308 and up			
60 FourStroke (Carb)	USA 0T178500 - 0T598999	N/A	N/A	826398T 3
	BEL 0P094500 - 0P206999			
60 FourStroke (EFI)	USA 0T409000 - 1B226999	N/A	N/A	899106T01
	BEL 0P153500 - 0P400999			
	CHN 1C000001 and up			
65 (650)(4 cyl)	2119749 - 2803561	21- 30430A 1	23014A 1	N.L.A.
65 (650)(4 cyl)	2803562 - 3293183	N.L.A.	N.L.A.	N.L.A.
65 (650)(3 cyl)	USA 3293184 - 4571651	21- 30430A 3	N.L.A.	N.L.A.
	AUS 8006640 and up			
	BEL 9020074 - 9135824			
	CAN 7013633 - 7087822			
65 JET	USA 0D283222 and up	N/A	21-857005A 1(2)	14360A78
70 (3 cyl)	USA 4571652 - 6428680	21-8M0084275	55278A 4	N.L.A.
	AUS 8042350 and up			
	BEL 9135825 - 9385910			
	CAN 7087823 - 7208332			
70 (3 cyl)	USA 0A996142 - 0C221999	N/A	42909A 4	14360A78
	BEL 9483121 - 9589038			
75 (4 cyl)	USA 6432901 and up	21-8M0084276(4)	55278A 5	N.L.A.(4)
	BEL 9393856 and up			
	CAN 7208573 and up			
75 (4 cyl)	USA 6432901 and up	N/A	21-857005A 1(3)	14360A78(3)
	BEL 9393856 and up			
	CAN 7208573 and up			

Model	Serial # Range	Check Valve Kit	Diaphragm Kit	Mechanical Fuel Pump
75 (3 cyl)	USA 0C222000 - 0D283221	N/A	42909A 4(1)	14360A78
	BEL 9589039 - 9793576			
75 (3 cyl)	USA 0C222000 - 0D283221	N/A	21-857005A 1(2)	14360A78
	BEL 9589039 - 9793576			
75 (3 cyl)	USA 0D283222 and up	N/A	21-857005A 1	14360A78
	BEL 9793577 and up			
75 DFI (3 cyl)	USA 0T980000 and up	N/A	21-857005A 1	14360T74
75 FourStroke (Carb)	USA 0G960500 - 0T408999	N/A	N/A	804249T 1
75 FourStroke (Carb)	USA 0T409000 - 1B226999	N/A	N/A	880890T 1
75 FourStroke (EFI)	USA 1B172291 - 1B366822	N/A	N/A	880890A02
80 (800)(4 cyl)	2559001 - 2670574	21- 30430A 1	23014A 1	N.L.A.
80 (800)(4 cyl)	2783253 - 2856331	21- 30430A 3	N.L.A.	N.L.A.
80 (800)(4 cyl)	2886332 - 3493912	21-8M0084276	55278A 5	N.L.A.
80 (80, 800)(4 cyl)	USA 4831999 - 6432900	21-8M0084276	55278A 5	N.L.A.
	AUS 8050200 and up			
	BEL 9177626 - 9393855			
	CAN 7110998 - 7208572			
80 (3 cyl)	USA 0A996142 - 0C221999	N/A	42909A 4	14360A78
	BEL 9483121 - 9589038			
80 JET (4 cyl.)	USA 0D283222 and up	N/A	21-857005A 1	14360A78
	BEL 9793577 - 0P325499			
80 JET (3 cyl.)	USA 1B586067 and up	N/A	21-857005A 1	14360T74
85 (850)(4 cyl)	USA 3493913 - 4831998	21-8M0084276	55278A 5	N.L.A.
	AUS 8005440 - 8050199			
	BEL 9011604 - 9177625			
	CAN 7010108 - 7110997			
90 (90, 900)(6 cyl)	USA 4845301 - 5299505	21- 30430A 7	89031A 1	N.L.A.
	CAN 7111698 - 7123762			
90 (6 cyl)	USA 5299506 - 6436122	21-8M0084277	89031A 3	N.L.A.
	AUS 8060545 and up			
	CAN 7147088 - 7208847			
90 (6 cyl)	USA 6436123 and up	N/A	21-857005A 1(3)	14360A78(3)
	CAN 7208848 and up			
90 (3 cyl)	USA 0A996142 - 0C221999	N/A	42909A 4	14360A78
	BEL 9483121 - 9589038			
90 (3 cyl)	USA 0C222000 - 0D283221	N/A	21-857005A 1(2)	14360A78
	BEL 9589039 - 9793576			
90 (3 cyl)	USA 0C222000 - 0D283221	N/A	42909A 4(1)	14360A78
	BEL 9589039 - 9793576			
90 (3 cyl)	USA 0D283222 and up	N/A	21-857005A 1	14360A78
	BEL 9793577 and up			
90 DFI (3 cyl)	USA 0T801000 and up	N/A	21-857005A 1	14360T74
90 FourStroke (Carb)	USA 0G960500 - 0T408999	N/A	N/A	804249T 1
90 FourStroke (Carb)	USA 0T409000 - 1B226999	N/A	N/A	880890T 1
90 FourStroke (EFI)	USA 1B172291 - 1B366822	N/A	N/A	880890A02
95 (950)(6 cyl)	1869776 - 2318585	21- 30430A 1	23014A 1	N.L.A.
100 (1000SS/BP)(6 cyl)	2318586 - 3253111	21- 30430A 1	23014A 1	N.L.A.
100 (4 cyl)	USA 0B209468 - 0D283221	N/A	42909A 4(1)	14360A78
	BEL 9523034 - 9793576			
100 (4 cyl)	USA 0B209468 - 0D283221	N/A	21-857005A 1(2)	14360A78
	BEL 9523034 - 9793576			
100 (4 cyl)	USA 0D283222 - 0G965520	N/A	21-857005A 1	14360A78
	BEL 9793577 - 0P058999			

Not all parts listed are available for the European, C.I.S., Africa and Middle East Markets.  
 For more information, please contact your local Mercury, Mariner, MerCruiser or Quicksilver Office.

# FUEL SYSTEM

Model	Serial # Range	Check Valve Kit	Diaphragm Kit	Mechanical Fuel Pump
110 (1100)(6 cyl)	1870204 - 2314955	21- 30430A 1	23014A 1	N.L.A.
115 (1150)(6 cyl)	USA 2836019 - 3761034	21- 30430A 3	55278A 1	N.L.A.
	AUS 8008665 - 8014004			
	CAN 7010763 - 7025597			
115 (115, 1150)(6 cyl)	USA 3761035 - 5314655	21- 30430A 7	89031A 1	N.L.A.
	AUS 8014005 - 8061119			
	CAN 7025598 - 7131212			
115 (115, 1150)(6 cyl)	USA 5314656 - 6436122	21-8M0084277	89031A 3	N.L.A.
	AUS 8061120 and up			
	CAN 7131213 - 7208847			
115 (115, 1150)(6 cyl)	USA 6436123 and up	21-8M0084277(4)	89031A 3(4)	N.L.A.
	CAN 7208848 and up			
115 (115, 1150)(6 cyl)	USA 6436123 and up	N/A	21-857005A 1(3)	14360A78
	CAN 7208848 and up			
115 (4 cyl)	USA 0D283222 and up	N/A	21-857005A 1	14360A78
	BEL 9793577 and up			
115 DFI (6 cyl)	USA 0G960500 - 0T178999	N/A	21-857005A 1	14360T75
115 DFI (3 cyl)	USA 0T801000 and up	N/A	21-857005A 1	14360T74
115 Pro XS	USA 1B751825 and up	N/A	21-857005A 1	14360T74
115 FourStroke (EFI)	USA 0T178500 - 1B366822	N/A	N/A	880890T 1
125 (1250)(6 cyl)	2314956 - 2839368	21- 30430A 1	23014A 1	N.L.A.
125 (1250BP)(6 cyl)	2400058 - 2641954	21- 30430A 1	23014A 1	N.L.A.
125 (4 cyl)	USA 0D283222 and up	N/A	21-857005A 1	14360A78
	BEL 9793577 and up			
125 DFI (3 cyl)	USA 1B736885 and up	N/A	21-857005A 1	14360T74
135 (1350)(6 cyl)	2839369 - 3293233	21- 30430A 3	55278A 1	N.L.A.
140 (1400)(6 cyl)	3293234 - 3502805	21- 30430A 3	55278A 1	N.L.A.
140 (140, 1400)(6 cyl)	USA 4865678 - 5327662	21- 30430A 7	89031A 1	N.L.A.
	AUS 8052650 - 8052879			
	CAN 7112773 - 7132512			
140 (6 cyl)	USA 5327663 and up	21-8M0084277	89031A 3	N.L.A.
	AUS 8066065 and up			
	CAN 7132513 and up			
140 JET	USA 0G303046 - 0T178499	N/A	21-857005A 1	14360A78
150 (1500)(6 cyl)	USA 3502806 - 4865677	21- 30430A 3	55278A 1	N.L.A.
	AUS 8005615 - 8052649			
	CAN 7010533 - 7112772			
150 (1500XS)(6 cyl)	USA 4868648 - 5327662	21- 30430A 8	89031A 2	N.L.A.
V-135	USA 0A904646 - 0C100860	21- 30430A 8(4)	89031A 2(4)	N.L.A.(4)
V-135	USA 0A904646 - 0D081999	N/A	21-857005A 1(3)	15930A15
V-135	USA 0D082000 - 0T178499	N/A	21-857005A 1	14360A78
V-135 DFI (Design I)	USA 0G590000 - 0G760299	N/A	N/A	N.L.A.
V-135 DFI (Design II)	USA 0G590000 - 0G760299	N/A	21-857005A 1	14360T75
V-135 DFI	USA 0G760300 and up	N/A	21-857005A 1	14360T75
V-1500 (150hp)	USA 4868998 - 0A904645	21- 30430A 8	89031A 2	N.L.A.
V-150	USA 0A904646 - 0C100860	21- 30430A 8(4)	89031A 2	N.L.A.
V-150	USA 0A904646 - 0C100860	N/A	21-857005A 1(3)	15930A15
V-150	USA 0C100861 - 0D081999	N/A	21-857005A 1	15930A15
V-150 (Carb & EFI)	USA 0D082000 - 1B226999	N/A	21-857005A 1	14360A78
V-150 DFI (Design I)	USA 0G590000 - 0G760299	N/A	21-857005A 1	N.L.A.
V-150 DFI (Design II)	USA 0G590000 - 0G760299	N/A	21-857005A 1	14360T75
V-150 DFI	USA 0G760300 and up	N/A	21-857005A 1	14360T75
XR-4	USA 0B242885 - 0D081999	N/A	21-857005A 1	15930A15
XR-6	USA 0D082000 and up	N/A	21-857005A 1	14360A78

Model	Serial # Range	Check Valve Kit	Diaphragm Kit	Mechanical Fuel Pump
V-175	USA 4301235 - 0C100860 AUS 8058870 and up	21- 30430A 8(4)	89031A 2(4)	N.L.A.
V-175	USA 4301235 and up AUS 8058870 and up	N/A	21-857005A 1(3)	
V-175	USA 0C100861 - 0D303045	N/A	21-857005A 1	15930A15
V-175	USA 0D303046 - 0G960499	N/A	21-857005A 1	14360A78
V-175 EFI	USA 0D000750 - 0D081999	N/A	21-857005A 1	15930A15
V-175 EFI	USA 0D082000 - 0T408999	N/A	21-857005A 1	14360A78
V-175 EFI	USA 0T409000 - 0T800999	N/A	21-857005A 1	14360T75
V-175 DFI	USA 0T178500 and up	N/A	21-857005A 1	14360T75
V-175 Pro XS	USA 1B516339 and up	N/A	21-857005A 1	14360T75
V-200, V-2000	USA 4839034 - 6073191 AUS 8061595 - 8065672	21- 30430A 8	89031A 2	N.L.A.
V-200	USA 6073192 - 6357229	N.L.A.	90363A 1	N.L.A.
V-200	USA 6357230 - 6625220	N.L.A.	89031A 4	N.L.A.
V-200	USA 6625221 - 0C291519	N/A	21-857005A 1	15930A15
V-200	USA 0C291520 - 1B226999	N/A	21-857005A 1	14360A78
V-200 EFI	USA 0C100861 - 0D081999	N/A	21-857005A 1	15930A15
V-200 EFI	USA 0D082000 - 0T408999	N/A	21-857005A 1	14360A78
V-200 EFI (2.5L)	USA 0T409000 and up	N/A	21-857005A 1	14360T75
V-200 EFI (3.0L)	USA 0T750164 and up	N/A	21-857005A 1	14360A78
V-200 DFI	USA 0G590000 - 0T598999	N/A	21-857005A 1	14360A78
V-200 DFI	USA 0T599000 - 0T800999	N/A	21-857005A 1	14360T77
V-200 DFI	USA 0T801000 and up	N/A	21-857005A 1	14360T74
V-200 Pro XS	USA 1B504989 and up	N/A	21-857005A 1	14360T74
V-220 LASER	USA 0B117316 and up	N/A	21-857005A 1	15930A15
V-225	USA 5628028 and up	N.L.A.	90363A 1	N.L.A.
V-225/225 SEA-PRO/ MARTHON (3.0L)	USA 0D280813 and up	N/A	21-857005A 1	14360A78
V-225 EFI (3.0L)	USA 0G129222 and up	N/A	21-857005A 1	14360A78
V-225 DFI	USA 0G590000 - 0T598999	N/A	21-857005A 1	14360A78
V-225 DFI	USA 0T599000 - 0T800999	N/A	21-857005A 1	14360T77
V-225 DFI	USA 0T801000 and up	N/A	21-857005A 1	14360T74
V-225 DTS	USA 0T599000 - 1B417701	N/A	21-857005A 1	14360T77
V-225 DTS	USA 1B417702 and up	N/A	21-857005A 1	14360T74
V-225 Pro XS	USA 1B104549 and up	N/A	21-857005A 1	14360T74
V-250 (3.4L)	USA 0C101891 and up	N/A	21-857005A 1	14360A78
V-250 EFI (3.0L)	USA 0G129222 and up	N/A	21-857005A 1	14360A78
V-250XB	USA 0G980600 - 0T800999	N/A	21-857005A 1	14360A78
V-250 DFI	USA 1B528615 and up	N/A	21-857005A 1	14360T74
V-250 Pro XS	USA 1B426561 and up	N/A	21-857005A 1	14360T74
V-275 (3.4L)	USA 0C101891 and up	N/A	21-857005A 1	14360A78
V-300 (3.4L)	USA 5611648 and up	21- 30430A 8	89031A 2	N.L.A.

- (1) 90 Degree Oil Check Valve
- (2) Inline Oil Check Valve
- (3) Use With Square Fuel Pump
- (4) Use With Triangular Fuel Pump

**FUEL SYSTEM**

**CARBURETOR GASKETS & GASKET KITS**

**FLOAT BOWL COVER GASKET**



**1399- 99**  
Priced individually, sold @ multiples of 10

**GASKET**

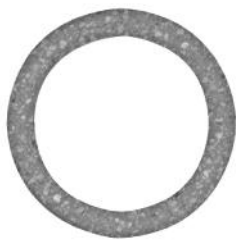

**1399- 5207**  
Priced individually, sold @ multiples of 3

**GASKET**



**27- 13937 6**

**GASKET**



**27- 15172 4**

**GASKET**



**27- 25848**  
Priced individually, sold @ multiples of 5

**GASKET**

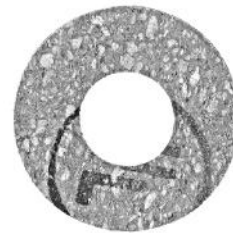

**27- 25849**  
Priced individually, sold @ multiples of 5

**GASKET**

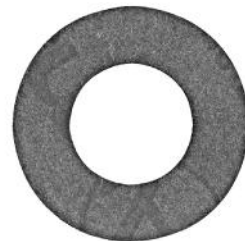

**27- 25851**  
Priced individually, sold @ multiples of 5

**GASKET**

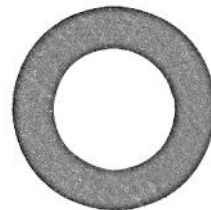

**27- 29586**  
Priced individually, sold @ multiples of 5



GASKET

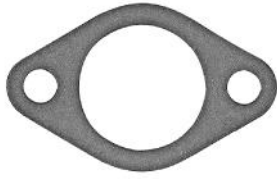

27-31402

Priced individually, sold @ multiples of 5

GASKET

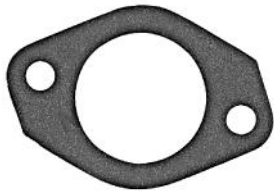

27-48164 1

Priced individually, sold @ multiples of 5

GASKET



27-63309

Priced individually, sold @ multiples of 3

GASKET

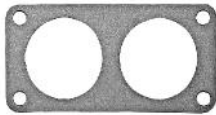

27-67751 1

Priced individually, sold @ multiples of 5

GASKET



27-73377 1

GASKET



27-75791 1

GASKET



27-76952

Priced individually, sold @ multiples of 2

GASKET

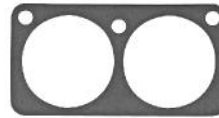

27-89221 1

GASKET

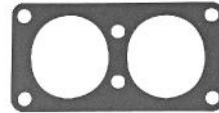

27-90430 1

GASKET



27-828319

GASKET



27-828925

**FUEL SYSTEM**

**GASKET**

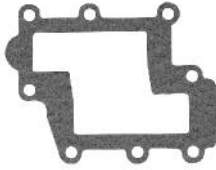

27-F433168

**GASKET**

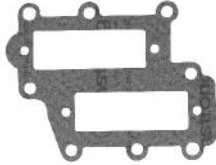

27-F433406

**GASKET**



27-F440906

**GASKET**



27-F481836

**GASKET SET**



27-803508A99

Fits the 4/5/6 hp. FourStroke outboards s/n 0R057259 & prior.

**GASKET SET**



1399- 1717

**DIAPHRAGM & GASKET KIT**



1395- 9761 1

**GASKET SET**

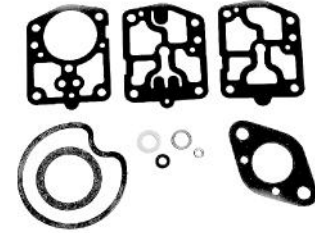

1399- 5135

**DIAPHRAGM & GASKET KIT**



1395- 9027

**DIAPHRAGM & GASKET KIT**



1399- 8154

CARBURETOR GASKET SET



1399- 2015

DIAPHRAGM & GASKET KIT

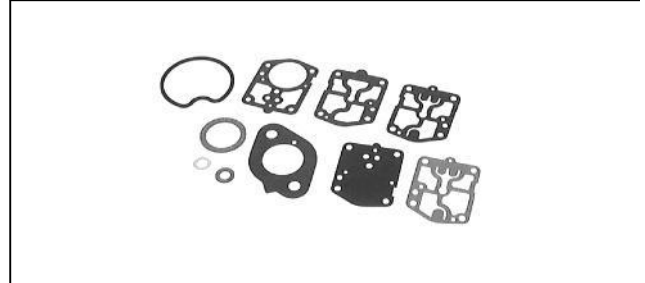

1395- 9024

GASKET SET

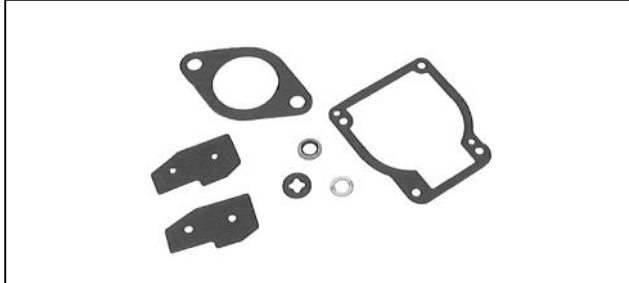

1395-811223 1

GASKET SET

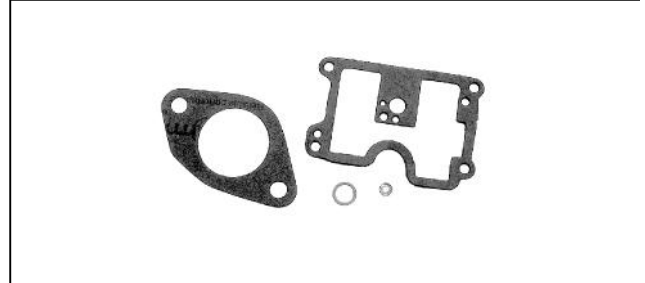

1395- 6200

GASKET SET

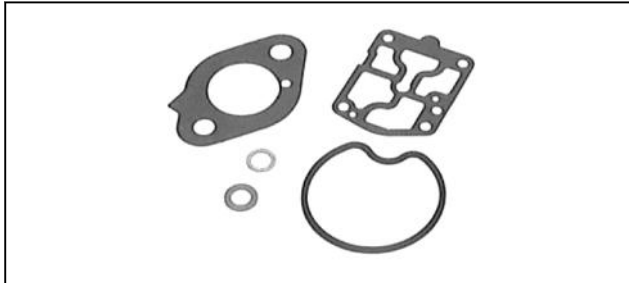

1395- 9651

GASKET SET



810749 2

GASKET SET



1395-879194024

GASKET SET

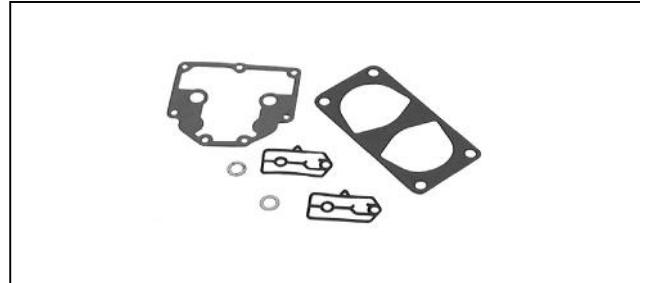

810749 3

GASKET SET

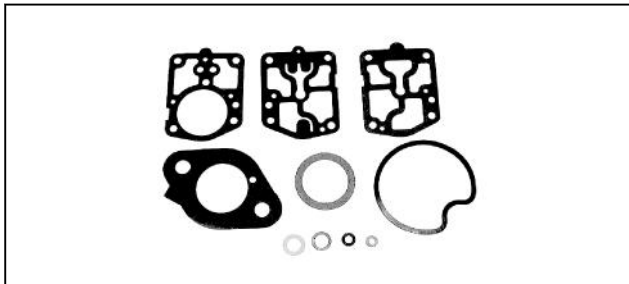

1399- 5198

GASKET SET



1395- 6452

Not all parts listed are available for the European, C.I.S., Africa and Middle East Markets.  
For more information, please contact your local Mercury, Mariner, MerCruiser or Quicksilver Office.

**CARBURETOR REPAIR KITS - MERCURY/MARINER**

**CARBURETOR REPAIR KIT**



1395- 5109 1

**CARBURETOR REPAIR KIT**



1399- 5199 1

**CARBURETOR REPAIR KIT**



1395- 7826

**CARBURETOR REPAIR KIT**



1399- 8153

**CARBURETOR REPAIR KIT**



1395- 8506

**CARBURETOR REPAIR KIT**



1395- 9023

**CARBURETOR REPAIR KIT**



1395- 9026

**CARBURETOR REPAIR KIT**



1395- 9262 1

**CARBURETOR REPAIR KIT**



1395- 9648 1

**CARBURETOR REPAIR KIT**



1395- 9650

CARBURETOR REPAIR KIT

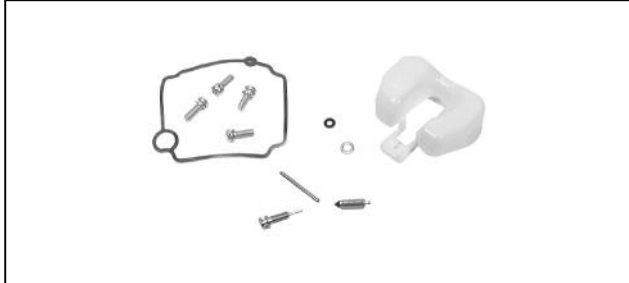

802706A 1

CARBURETOR REPAIR KIT



1395-811691 3

CARBURETOR REPAIR KIT



809449A 1

CARBURETOR REPAIR KIT



812953

CARBURETOR REPAIR KIT

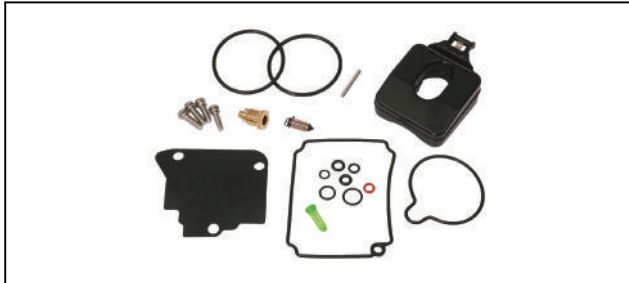

804346T02

CARBURETOR REPAIR KIT



1395-823635 4

CARBURETOR REPAIR KIT



809594A 1

CARBURETOR REPAIR KIT



1395-823707 2

CARBURETOR REPAIR KIT



1395-811691 2

CARBURETOR REPAIR KIT

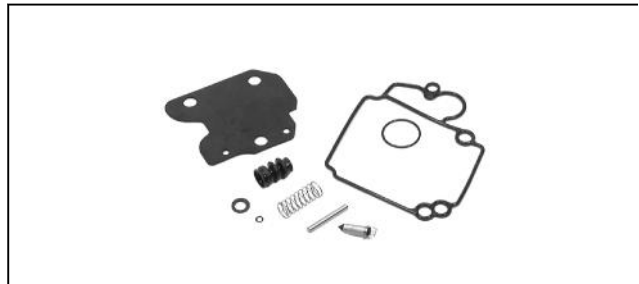

854256

Not all parts listed are available for the European, C.I.S., Africa and Middle East Markets.  
 For more information, please contact your local Mercury, Mariner, MerCruiser or Quicksilver Office.

**FUEL SYSTEM**

**CARBURETOR REPAIR KIT**



854256 1

**CARBURETOR REPAIR KIT**



855546A 1

**CARBURETOR REPAIR KIT**



855546A 3

**CARBURETOR REPAIR KIT**



855546A 4

**CARBURETOR REPAIR KIT**



8M0090764

**CARBURETOR REPAIR KIT**



1399-879194026

**CARBURETOR REPAIR KIT**



8M0044575

Includes new float, float pin, inlet needle, bowl gasket and flange gaskets. Fits the carburetor on the F4/5/6 hp. FourStroke outboards, serial number 0R000001 and above.

**NEW**

**CARBURETOR REPAIR KIT**



8M0044576

Includes new float, float pin, inlet needle, bowl gasket, air box o-ring and flange gaskets. Fits the carburetor on the F8/9.9 hp. FourStroke outboards, serial number 0R042475 and above.

**NEW**

**CARBURETOR REPAIR KIT**

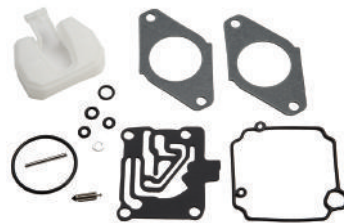

8M0044577

Includes new float, float pin, inlet needle, bowl gasket, air box o-ring and flange gaskets. Fits the carburetor on the F15/20 hp. FourStroke outboards, serial number 0R235168 and above.

**NEW**

**CARBURETOR REPAIR KITS - EARLY MARINER**

**CARBURETOR REPAIR KIT**

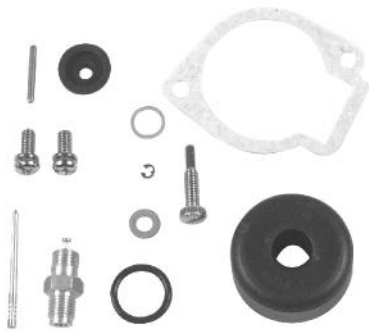

41859M

**CARBURETOR REPAIR KIT**

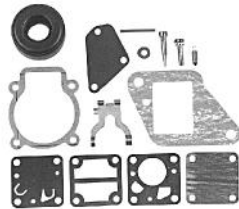

91755T

**CARBURETOR REPAIR KIT**



14184T

**CARBURETOR REPAIR KIT**



11502M

**CARBURETOR REPAIR KIT**



84473T

**CARBURETOR REPAIR KIT**



814481M

**CARBURETOR REPAIR KIT**



811038M

**CARBURETOR REPAIR KIT**



94500M



# FUEL SYSTEM

## CARBURETOR REPAIR KIT



97667T

## CARBURETOR REPAIR KIT



17068M

## CARBURETOR REPAIR KIT

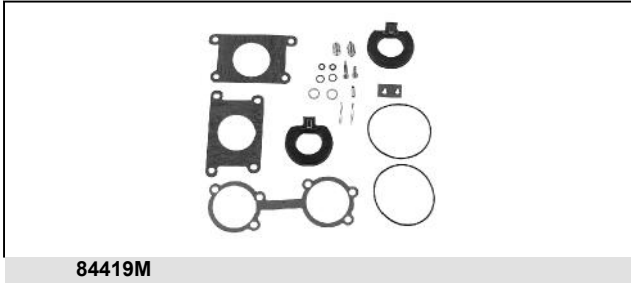

84419M

## CARBURETOR DIAPHRAGM KITS

### DIAPHRAGM & GASKET KIT



1395- 9761 1

## DIAPHRAGM KIT

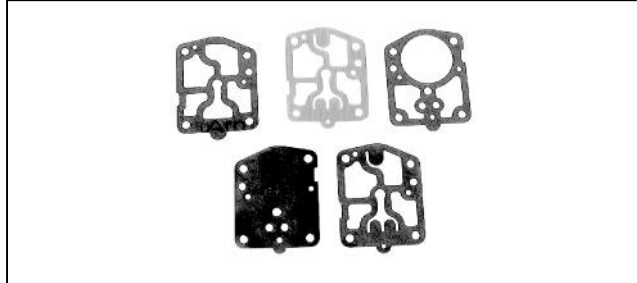

1399- 5137

## DIAPHRAGM & GASKET KIT

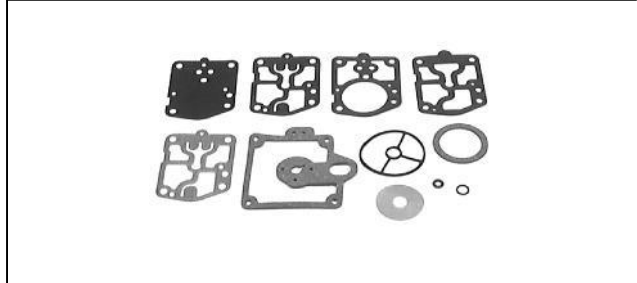

1399- 8154

## DIAPHRAGM & GASKET KIT



1395- 9024

## FUEL PUMP DIAPHRAGM

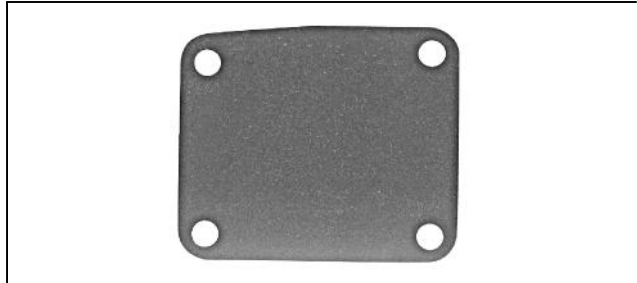

11497M

## FUEL PUMP DIAPHRAGM

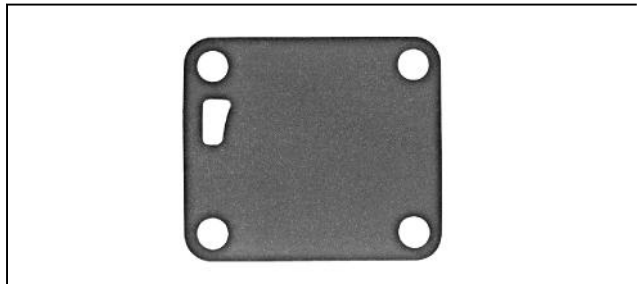

84262M



**FUEL PUMP DIAPHRAGM**

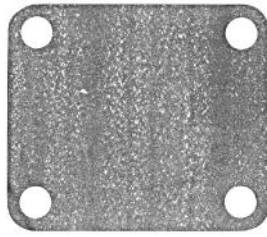

84265M

**INLET NEEDLE ASSEMBLIES**

**INLET NEEDLE & SEAT ASSEMBLY**



1395- 7624

**INLET NEEDLE & SEAT ASSEMBLY**



1395- 7824

**INLET NEEDLE & SEAT ASSEMBLY**



1395- 8318 1

**INLET NEEDLE & SEAT ASSEMBLY**



1395- 9258 1

**INLET NEEDLE & SEAT ASSEMBLY**



17050M

**INLET NEEDLE & SEAT ASSEMBLY**



19271 1

**INLET NEEDLE & SEAT ASSEMBLY**



95263A 1

**INLET NEEDLE & SEAT ASSEMBLY**



1395-811690 1

**FUEL SYSTEM**

**INLET NEEDLE ASSEMBLY**



1395- 9022

**INLET NEEDLE ASSEMBLY**



1395-803861

**INLET NEEDLE ASSEMBLY**



1395-879194011

**INLET NEEDLE ASSEMBLY**

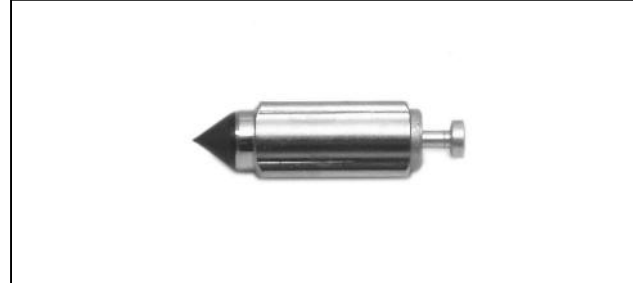

809570

**INLET NEEDLE ASSEMBLY**



14182M

**INLET NEEDLE ASSEMBLY**



809570 1

**INLET NEEDLE ASSEMBLY**



16254

**INLET NEEDLE ASSEMBLY**



809570002

**INLET NEEDLE ASSEMBLY**



16254 3

Fits Mercury/Mariner 8/9.9 hp. FourStroke outboards, beginning with Model Year 2005.

INLET NEEDLE ASSEMBLY



854247

INLET NEEDLE ASSEMBLY



F10265

FLOATS

FLOAT ASSEMBLY



1395- 5898

FLOAT ASSEMBLY

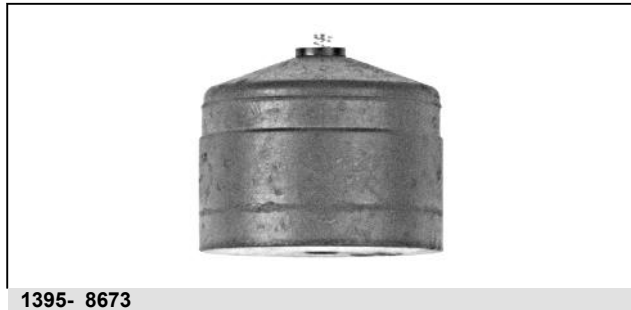

1395- 8673

FLOAT ASSEMBLY



1395- 9169 1

FLOAT ASSEMBLY



1395- 9293

FLOAT ASSEMBLY



1395- 9594

FLOAT ASSEMBLY



16253

# FUEL SYSTEM

## FLOAT ASSEMBLY



16253 2

Fits Mercury/Mariner 8/9.9 hp. FourStroke outboards, beginning with Model Year 2005.

## FLOAT ASSEMBLY



16253 3

## FLOAT ASSEMBLY



19273

## FLOAT ASSEMBLY



95259

## FLOAT ASSEMBLY



804184

## FLOAT ASSEMBLY



809569

## FLOAT ASSEMBLY



810738

## FLOAT ASSEMBLY



1395-823620

## FLOAT ASSEMBLY



854253

**FLOAT ASSEMBLY**



**854253 1**

**FLOAT ASSEMBLY**



**898103245**

**FLOAT ASSEMBLY**



**891730A01**

**CARBURETOR REPAIR CHARTS**

**Mercury/Mariner InLine Carburetor Repair Kits**

Model	Carb # or SN	Diaphragm Kit	Float	Gasket Kit	Inlet Needle Assy	Repair Kit
2.5	Serial #USA-0G710613 & Above Serial #BEL-0P017000 & Above	N/A	95259	N.L.A.	95263 1	855546A 4
2.5 FourStroke	Serial #JPN-0R131842-0R131841	N/A	898101288	N/A	16254 3	898103A68
2.5 FourStroke	Serial #JPN-0R131842 & Above	N/A	898103245	N/A	16254 3	8M0090764
3.3	Serial #USA-0G710613 & Above Serial #BEL-0P017000 & Above	N/A	95259	N.L.A.	95263 1	855546A 4
3.5 FourStroke	Serial #JPN-0R131842-0R131841	N/A	898101288	N/A	16254 3	898103A68
3.5 FourStroke	Serial #JPN-0R131842 & Above	N/A	898101288	N/A	16254 3	8M0090764
3.9 (39)	KB-7A,KB-7B	N/A	1395- 8673	1399- 1717	1395- 9258 1	1395- 9262 1(1)(2)
4 (40)(1 cyl)	KB-10A	N/A	1395- 8673	1399- 1717	1395- 9258 1	1395- 9262 1(1)(2)
4 (1 cyl)	WMD-1	N/A	1395- 8673	1399- 1717	1395- 8318 1	N.L.A.
4 (1 cyl)	Serial USA-0A855097 & Above Serial BEL-9589154 & Above	N/A	16253	N.L.A.	16254	855546A 1
4 (2 cyl)	LMO-1	N/A	1395- 5898	N.L.A.	(4)	N.L.A.
4 (2 cyl)	LMO-2	N/A	1395- 5898	N.L.A.	N.L.A.	N.L.A.
4 (2 cyl)	LMO-3	N/A	1395- 5898	N.L.A.	(4)	N.L.A.
4 (2 cyl)	LMO-4	N/A	1395- 5898	N.L.A.	(4)	N.L.A.
4 FourStroke	Serial# JPN 0R000001 & above	N/A	16253 3	N/A	16254 3	8M0044575
4.5 (1 cyl)	KB-10A	N/A	1395- 8673	1399- 1717	1395- 9258 1	1395- 9262 1(1)(2)
4.5 (1 cyl)	WMD-1	N/A	1395- 8673	1399- 1717	1395- 8318 1	N.L.A.
5 (1 cyl)	Serial USA-0A855097 & Above Serial BEL-9589154 & Above	N/A	16253	N.L.A.	16254	855546A 1
5 FourStroke	Serial# JPN 0R000001 & Above	N/A	16253 3	N/A	16254 3	8M0044575
6	KB-6A, 6B	N/A	1395- 8673	1399- 1717	1395- 9258 1	1395- 9262 1
6	AJ-57A	N/A	1395- 8673	N.L.A.	1395- 9258 1	N.L.A.

**Not all parts listed are available for the European, C.I.S., Africa and Middle East Markets.  
For more information, please contact your local Mercury, Mariner, MerCruiser or Quicksilver Office.**

# FUEL SYSTEM

Model	Carb # or SN	Diaphragm Kit	Float	Gasket Kit	Inlet Needle Assy	Repair Kit
6	WMC-5,5A,5B,7,7A,17,17B,17C,18,18,18B,19,19A,20,20	1395- 9761 1	1395- 9169 1	1395- 9761 1	1395-803861	1395- 9648 1
6	WMC-23,28,34,39,41,41A,47,47A,49,49A,57	1395- 9761 1	1395- 9169 1	1395- 9761 1	1395-803861	1395-823707 2
6 FourStroke	Serial# JPN 0R000001 & Above	N/A	16253 3	N/A	16254 3	8M0044575
7.5 (7.5, 75)	BB-2A,2B,2C,4A,5A,5B,5C,5D,7A,7C	1399- 5137	1395- 9293	1399- 5135	1395- 9022	1399-879194026
7.5 (7.5, 75)	KB-9A, 12A	N/A	1395- 8673	1399- 1717	1395- 9258 1	1395- 9262 1
7.5	WMB-2,4	N/A	1395- 9293	1395- 9027	1395- 9022	1395- 9026
8	WMC-5,5A,5B,7,7A,17,17B,17C,18,18A,18B,19,19A,20,2	1395- 9761 1	1395- 9169 1	1395- 9761 1	1395-803861	1395- 9648 1
8	WMC-23,28,34,39,41,41A,47,47A,49,49A,57	1395- 9761 1	1395- 9169 1	1395- 9761 1	1395-803861	1395-823707 2
8 (4-Stroke)(232 cc)	Serial# USA-0H000058-0T979999	N/A	N.L.A.	N.L.A.	14182M	N.L.A.
8 (4-Stroke) (323cc)	Serial# BEL 0P086824-0P325499	N/A	809569	N.L.A.	809570 1	802706A 1
8 FourStroke	Serial# JPN 0R042475 & above Serial# BEL 0P325500 & above	N/A	16253 2	N/A	809570002	8M0044576
9.8 (9.8, 110)	BB-1A,1B,1C,3A,3B,3C,6A,6C	1399- 5137	1395- 9293	1399- 5135	1395- 9022	1399-879194026
9.8 (9.8, 110)	KB-5A,8A,11A	N/A	1395- 8673	1399- 1717	1395- 9258 1	1395- 9262 1
9.8	WMB-1, 3	N/A	1395- 9293	1395- 9027	1395- 9022	1395- 9026
9.9	WMC-5,5A,5B,7,7A,17,17B,17C,18,18A,18B,19,19A,20,2	1395- 9761 1	1395- 9169 1	1395- 9761 1	1395-803861	1395- 9648 1
9.9	WMC-23,28,34,39,41,41A,47,47A,49,49A,57	1395- 9761 1	1395- 9169 1	1395- 9761 1	1395-803861	1395-823707 2
9.9 (4-Stroke) (232cc)	Serial# USA-0H000058 & 0H017099	N/A	N.L.A.	N.L.A.	14182M	N.L.A.
9.9 (4-Stroke) (323cc)	Serial# USA-0G760300-0T979999	N/A	809569	N.L.A.	809570 1	802706A 1
9.9 (4-Stroke) (323cc)	Serial# BEL 0P075166-0P325499	N/A	809569	N.L.A.	809570 1	802706A 1
9.9 FourStroke	Serial# JPN 0R042475 & above Serial# BEL 0P325500 & above	N/A	16253 2	N/A	809570002	8M0044576
10 (100)	AJ-56AB	N/A	1395- 8673	N.L.A.	1395- 9258 1	N.L.A.
10 (100)	KB-1A, 4A	N/A	1395- 8673	1399- 1717	1395- 9258 1	N.L.A.
10 (Sea Pro, Marathon)	WMC-33,33A,40,42,50,50A,50B,55,55A	1395- 9761 1	1395- 9169 1	1395- 9761 1	1395-803861	1395-823707 2
10 (XR10, Magnum10)	WMC-23,48,48A,49,49A	1395- 9761 1	1395- 9169 1	1395- 9761 1	1395-803861	1395-823707 2
15 (150)	KB-1A, 4A	N/A	1395- 8673	1399- 1717	1395- 9258 1	N.L.A.
15	WMC-5,5A,5B,7,7A,17,17B,17C,18,18A,18B,19,19A,20,2	1395- 9761 1	1395- 9169 1	1395- 9761 1	1395-803861	1395- 9648 1
15	WMC-23,28,34,39,41,41A,47,47A,49,49A,57	1395- 9761 1	1395- 9169 1	1395- 9761 1	1395-803861	1395-823707 2
15 (Super 15,15XD)	WMC-13,13A,14,14A,15A,16A,24,25,26,27,29,30,31,31A	1395- 9761 1	1395- 9169 1	1395- 9761 1	1395-803861	1395-823707 2
15 (Sea Pro, Marathon)	WMC-33,33A,40,42,50,50A,50B,55,55A	1395- 9761 1	1395- 9169 1	1395- 9761 1	1395-803861	1395-823707 2
15 FourStroke, 323cc	Serial# USA-0G590000-1B727495 Serial# BEL 0P075166 & Above	N/A	809569	N.L.A.	809570 1	802706A 1
15 FourStroke, 351cc	Serial# JPN 0R235949 & Above	N/A	16253 2	N/A	809570002	8M0044577
18	BC-1A,1B,1C,2A,2B,2D	1399- 8154	N.L.A.	1399- 8154	N.L.A.	1399- 8153
18	WMC-1,2,3,4,9,10,11,12	1395- 9761 1	1395- 9169 1	1395- 9761 1	1395-803861	1395- 9648 1
18	WMC-13,13A,14,14A,15A,16A,24,25,26,27,29,30,31,31A	1395- 9761 1	1395- 9169 1	1395- 9761 1	1395-803861	1395-823707 2
20 (200)	KA-22A,22B,22C,23A,25A	N/A	1395- 8673	1399- 2015	1395- 9258 1	1395- 9262 1
20 (20,200)	BA-1A,2A,2C,2D,2E	1399- 5137	1395- 9293	1399- 5198	(4)	1399- 5199 1
20 (20,200)	BC-1A,1B,1C,2A,2B,2D	1399- 8154	N.L.A.	1399- 8154	N.L.A.	1399- 8153
20	WMC-1,2,3,4,9,10,11,12	1395- 9761 1	1395- 9169 1	1395- 9761 1	1395-803861	1395- 9648 1
20	WMC-13,13A,14,14A,15A,16A,24,25,26,27,29,30,31,31A	1395- 9761 1	1395- 9169 1	1395- 9761 1	1395-803861	1395-823707 2
20 JET	WMC-45, 53A	1395- 9761 1	1395- 9169 1	1395- 9761 1	1395-803861	1395-823707 2
20 FourStroke	Serial# JPN-0R235168 & Above	N/A	16253 2	N/A	809570002	8M0044577
25 (2cyl)	BC-1A,1B,1C,2A,2B,2D	1399- 8154	N.L.A.	1399- 8154	N.L.A.	1399- 8153
25 (2cyl)	WMC-1,2,3,4,9,10,11,12	1395- 9761 1	1395- 9169 1	1395- 9761 1	1395-803861	1395- 9648 1

Model	Carb # or SN	Diaphragm Kit	Float	Gasket Kit	Inlet Needle Assy	Repair Kit
25 (2cyl)	WMC-13,13A,14,14A,15A,16A,24,25,26,27,29,30,31,31A	1395- 9761 1	1395- 9169 1	1395- 9761 1	1395-803861	1395-823707 2
25 (3 cyl)	FD-3C, 3D	N/A	891730A01		F10265	809449A 1
25 FourStroke	Serial# USA-0G590000-0T408999 Serial# BEL-9973100-0P153499	N/A	854253	N.L.A.	854247	854256
25 FourStroke	Serial# USA-0409000-1B344298 Serial# BEL 0P153500-0P388282	N/A	854253 1	N.L.A.	854247	854256 1
25 FourStroke	Bodensee, Serial# BEL 0P017000-0P388282	N/A	854253	N.L.A.	854247	854256
30 (300)(4 cyl)	AJ-54A	N/A	1395- 8673	N.L.A.	1395- 9258 1	N.L.A.
30 (300)(4 cyl)	KB-2A	N/A	1395- 8673	1399- 1717	1395- 9258 1	N.L.A.
30 (2 cyl)(644cc)	WME-36,36A,37,37A,38,39A,42,42A,63,64,65,66,67	N/A	1395- 9594	1395-811223 1	1395-879194011	1395-823635 4
30 JET (4 cyl)	WMA 10, 13	N/A	1395-823620	1395- 9651	1395-879194011	1395- 9650
30 JET (3 cyl)	WME 53,68,69	N/A	1395- 9594	1395-811223 1	1395-879194011	1395-823635 4
30 FourStroke (3 cyl)	Serial# USA 0G760300-0T178499	N/A	854253	N/A	854247	854256
30 FourStroke (3 cyl)	Serial# USA 0T178500 & Above Serial# BEL 0P153500 & Above	N/A	854253 1	N/A	854247	854256 1
35 (350)(4 cyl)	AJ-54A	N/A	1395- 8673	N.L.A.	1395- 9258 1	N.L.A.
35 (350)(4 cyl)	KB-2A	N/A	1395- 8673	1399- 1717	1395- 9258 1	N.L.A.
35 (2 cyl)	KC-4A,8A,9A,9B,9C,13A	N/A	1395- 8673	1399- 2015	1395- 8318 1	1395- 9262 1
40 (400)(4 cyl)	KA-2A,9A	N/A	1395- 8673	1399- 2015	1395- 9258 1	N.L.A.
40 (40,400,402)(2 cyl)	KD-5A	N/A	1395- 8673	1395-879194024	1395- 9258 1	1395- 9262 1
40 (40,400,402)(2 cyl)	WMK-1,8,21,24,31,33,34,38	N/A	1395- 8673	1395-879194024	1395- 8318 1	1395- 5109 1
40 (2 cyl)(644cc)	WME-36,36A,37,37A,38,39A,42,42A,63,64,65,66,67	N/A	1395- 9594	1395-811223 1	1395-879194011	1395-823635 4
40 (3 cyl)	WME-53,68,69	N/A	1395- 9594	1395-811223 1	1395-879194011	1395-823635 4
40 (4 cyl)	WMA-4	1395- 9024	1395- 9293	1395- 9024	1395- 9022	1395- 9023
40 (4 cyl)	WMA-7B	N/A	1395- 9293	1395- 9651	1395-879194011	1395- 9650
40 (4 cyl)	WMA-9,10,13	N/A	1395-823620	1395- 9651	1395-879194011	1395- 9650
40 FourStroke (4 cyl)	Serial# USA-0G231123-0T178499	N/A	809569	N.L.A.	809570 1	809594A 1
40 FourStroke (4 cyl)	Serial# USA 0T228405-0T598999 Serial# BEL 0P094500-0P206999	N/A	854253 1	N/A	854247	854256 1
40 (4-Stroke)(3 cyl)	Serial# USA 0G760300-0T178499	N/A	854253	N/A	854247	854256
40 (4-Stroke)(3 cyl)	Serial# USA 0T178500 & Above Serial# BEL 0P153500 & Above	N/A	854253 1	N/A	854247	854256 1
45 (450)(4 cyl)	KA-17A	N/A	1395- 8673	1399- 2015	1395- 9258 1	1395- 9262 1
45 (4 cyl)	WMA-4	1395- 9024	1395- 9293	1395- 9024	1395- 9022	1395- 9023
45 (4 cyl)	WMA-7B	N/A	1395- 9293	1395- 9651	1395-879194011	1395- 9650
45 (4 cyl)	WMA-9,10,13	N/A	1395-823620	1395- 9651	1395-879194011	1395- 9650
45 (4-Stroke, Bodensee)	Serial# USA-0G231123 & Above	N/A	809569	N.L.A.	809570 1	809594A 1
45 JET (3 cyl)	WME-57,58	N/A	1395- 9594	1395-811223 1	1395-879194011	1395-823635 4
50 (4 cyl)	KA-13A,18A,19A,21A,21B,21C,21D,24A,26A,26B,27A	N/A	1395- 8673	1399- 2015	1395- 9258 1	1395- 9262 1
50 (4 cyl)	BA-3A,3B,3C,3D,4A	1399- 5137	1395- 9293	1399- 5198	1395- 9022	1399- 5199 1
50 (4 cyl)	WMA-1,3	1395- 9024	1395- 9293	1395- 9024	1395- 9022	1395- 9023
50 (4 cyl)	WMK-8	N/A	1395- 8673	1395-879194024	1395- 8318 1	1395- 5109 1
50 (3 cyl)	WM-13,13A,15,15A,16,16A,18	N/A	19273	1395- 6200	19271 1	812953
50 (3 cyl)	WME-22,22B,23,24,26,27,28,35,43,44,45,53,68,69	N/A	1395- 9594	1395-811223 1	1395-879194011	1395-823635 4
50 (4-Stroke)(935 cc)	Serial# USA 0T178500-0T598999	N/A	809569	N.L.A.	809570 1	809594A 1

Not all parts listed are available for the European, C.I.S., Africa and Middle East Markets.  
For more information, please contact your local Mercury, Mariner, MerCruiser or Quicksilver Office.

# FUEL SYSTEM

Model	Carb # or SN	Diaphragm Kit	Float	Gasket Kit	Inlet Needle Assy	Repair Kit
50 (4-Stroke)(995 cc)	Serial# USA 0T178500-0T598999 Serial# BEL 0P094500-0P206999	N/A	854253 1	N/A	854247	854256 1
55	WM-13,13A,15,15A,16,16A,18	N/A	19273	1395- 6200	19271 1	812953
55	WME-22,22B,23,24,26,27,28,35,43,44,45,57,58	N/A	1395- 9594	1395-811223 1	1395-879194011	1395-823635 4
60 (600)(6 cyl)	KB-3A	N/A	1395- 8673	1399- 1717	1395- 9258 1	N.L.A.
60 (3 cyl)	WM-13,13A,15,15A,16,16A,18	N/A	19273	1395- 6200	19271 1	812953
60 (3 cyl)	WME-22,22B,23,24,26,27,28,35,43,44,45,57,58	N/A	1395- 9594	1395-811223 1	1395-879194011	1395-823635 4
60 FourStroke (995 cc)	Serial# USA 0T178500-0T598999 Serial# BEL 0P094500-0P206999	N/A	854253 1	N/A	854247	854256 1
65 (650)(4 cyl)	KC-2A,5A,5B,5C,11A,15A	N/A	1395- 8673	1399- 2015	1395- 9258 1	1395- 9262 1
65 (650)(3 cyl)	WMK-5,12,13,20	N/A	1395- 8673	1395-879194024	1395- 8318 1	1395- 5109 1
65 (650)(3 cyl)	WM-2	N/A	1395- 8673	1395- 6200	1395- 8318 1	N.L.A.
65 (650)(3 cyl)	WM-4	N/A	1395- 8673	1395- 6200	1395- 8318 1	812953
65 JET (3 cyl)	WME-29,30,31,41,46,47,48,49,59,60,61,62,75,76,77,7	N/A	1395- 9594	1395-811223 1	1395-879194011	1395-823635 4
70 (700)(6 cyl)	KA-8A,12A	N/A	1395- 8673	1399- 2015	1395- 9258 1	1395- 9262 1
70 (3 cyl)	WM-6,8,9,11	N/A	19273	1395- 6200	1395- 8318 1	812953
70 (3 cyl)	WME-1,1A,1B,4,5,6,6A,7,7B,8,9,10,10A,15,15A,17,18,	N/A	1395- 9594	1395-811223 1	1395-879194011	1395-823635 4
75 (4 cyl)	WM-14,17	N/A	19273	1395- 6200	19271 1	812953
75 (3 cyl)	WME-1,1A,1B,4,5,6,6A,7,7B,8,9,10,10A,15,15A,17,18,	N/A	1395- 9594	1395-811223 1	1395-879194011	1395-823635 4
75 FourStroke	Serial# USA 0G960500-1B226999 Serial# BEL 0P094500 & Above	N/A	804184	N/A	17050M	804346T02
80 (800)(6 cyl)	KA-10A,11A,14A,16A,KC-3A	N/A	1395- 8673	1399- 2015	1395- 9258 1	N.L.A.
80 (80,800)(4 cyl)	KD-4A	N/A	1395- 8673	1395-879194024	1395- 8318 1	1395- 9262 1
80 (80,800)(4 cyl)	WM-5,10,12,14,17	N/A	19273	1395- 6200	1395- 8318 1	812953
80 (3 cyl)	WME-1,1A,1B,4,5,6,6A,7,7B,8,9,10,10A,15,15A,17,18,	N/A	1395- 9594	1395-811223 1	1395-879194011	1395-823635 4
80 JET (4 cyl)	WME-32,32A,50,79	N/A	1395- 9594	1395-811223 1	1395-879194011	1395-823635 4
85 (850)(6cyl)	KA-10A,11A,14A,16A,KC-3A	N/A	1395- 8673	1399- 2015	1395- 9258 1	N.L.A.
85 (850)(4 cyl)	WM-3,5	N/A	19273	1395- 6200	1395- 8318 1	812953
85 (850)(4 cyl)	WMK-4,16,17	N/A	1395- 8673	1395-879194024	1395- 8318 1	1395- 5109 1
90 (900)(6 cyl)	KC-6A	N/A	1395- 8673	1399- 2015	1395- 9258 1	1395- 9262 1
90 (90,900)(6 cyl)	WMK-23,27,30,35,39	N/A	1395- 8673	1395-879194024	1395- 8318 1	1395- 5109 1
90 (3 cyl)	WME-1,1A,1B,4,5,6,6A,7,7B,8,9,10,10A,15,15A,17,18,	N/A	1395- 9594	1395-811223 1	1395-879194011	1395-823635 4
90 FourStroke	Serial# USA 0G960500 & Above Serial# BEL 0P094500 & Above	N/A	804184	N/A	17050M	804346T02
95 (950)(6 cyl)	KC-6A	N/A	1395- 8673	1399- 2015	1395- 9258 1	1395- 9262 1
100 (1000) (6 cyl)	KC-1A,7A,7B,10A,14A	N/A	1395- 8673	1399- 2015	1395- 9258 1	1395- 9262 1
100 (1000) (6 cyl)	KD-1A,1B,2A,3A	N/A	1395- 8673	1395-879194024	1395- 8318 1	1395- 9262 1
100 (4 cyl)	WME-11,14,20,20A,21,21A,32,32A,50,79	N/A	1395- 9594	1395-811223 1	1395-879194011	1395-823635 4
110 (1100)(6 cyl)	KC-1A,7A,7B,10A,14A	N/A	1395- 8673	1399- 2015	1395- 9258 1	1395- 9262 1
115 (115,1150)(6 cyl)	KD-6A,6B	N/A	1395- 8673	1395-879194024	1395- 8318 1	1395- 9262 1
115 (115,1150)(6 cyl)	WMK-3,10,15,18,26,28,32,36,40,41	N/A	1395- 8673	1395-879194024	1395- 8318 1	1395- 5109 1
115 (4 cyl)	WME-11,14,20,20A,21,21A,33,40,40A	N/A	1395- 9594	1395-811223 1	1395-879194011	1395-823635 4
125 (1250)(6 cyl)	KD-1A,1B,2A,3A	N/A	1395- 8673	1395-879194024	1395- 8318 1	1395- 9262 1
125 (4 cyl)	WME-34,52,81	N/A	1395- 9594	1395-811223 1	1395-879194011	1395-823635 4
135 (1350)(6 cyl)	KD-7A,7B	N/A	1395- 8673	1395-879194024	1395- 8318 1	1395- 9262 1
135 (1350)(6 cyl)	WMK-4	N/A	1395- 8673	1395-879194024	1395- 8318 1	1395- 5109 1
140 (140,1400)(6 cyl)	WMK-7,9,25,29	N/A	1395- 8673	1395-879194024	1395- 8318 1	1395- 5109 1
150 (1500)(6 cyl)	WMK-11,14,19,22	N/A	1395- 8673	1395-879194024	1395- 8318 1	1395- 5109 1

(1) Kit does not include jet or idle needle.

(2) Kit does not include idle tube or nozzle.

(4) Included in carburetor repair parts kit.



**Mercury/Mariner V-6 Carburetor Repair Kits**

Model	Serial # Range	Carb #	Float	Gasket Kit	Inlet Needle Assy	Repair Kit
V-105 JET	USA 0D082000 - 0G303045	WMH-13, 13B, 23, 31	810738	810749 2	1395-811690 1	1395-811691 2
V-105 JET	USA 0G303046 and up	WMV-2, 2A	810738	810749 3	1395-811690 1	1395-811691 3
V-135	USA 0A904646 - 0C100860	WH-33, 40	N.L.A.	1395- 6452	1395- 7824	1395- 8506
V-135	USA 0A904646 - 0C100860	WH-32, 35, 38	N.L.A.	1395- 6452	1395- 7824	1395- 7826
V-135	USA 0C100861 - 0C239552	WH- 35, 38	N.L.A.	1395- 6452	1395- 7824	1395- 7826
V-135	USA 0C100861 - 0C239552	WH- 40, 48	N.L.A.	1395- 6452	1395- 7824	1395- 8506
V-135	USA 0C239553 - 0D081999	WMH- 8, 8A	810738	810749 2	1395-811690 1	1395-811691 2
V-135	USA 0D082000 - 0G303045	WMH-12A, 12B	810738	810749 2	1395-811690 1	1395-811691 2
V-135	USA 0D082000 - 0G303045	WMH-28, 30	810738	810749 2	1395-811690 1	1395-811691 2
V-135	USA 0G303046 - 0G760299	WMV-1, 1A	810738	810749 3	1395-811690 1	1395-811691 3
V-135	USA 0G760300 and up	WMV-1A, 15, 15A	810738	810749 3	1395-811690 1	1395-811691 3
V-140 JET	USA 0G082000 - 0G303045	WMH-16, 21, 34, 39	810738	810749 2	1395-811690 1	1395-811691 2
V-140 JET	USA 0G303046 - 0G760299	WMV-5, 5A	810738	810749 3	1395-811690 1	1395-811691 3
V-140 JET	USA 0G760300 and up	WMV-5A	810738	810749 3	1395-811690 1	1395-811691 3
V-150 (150,1500)	USA prior to - 0A904645	WH-9	N.L.A.	1395- 6452	1395- 7824	1395- 7826
V-150 (150,1500)	USA prior to - 0A904645	WH-12	N.L.A.	1395- 6452	1395- 7824	1395- 7826
V-150 (150,1500)	USA prior to - 0A904645	WH-29	N.L.A.	1395- 6452	1395- 7824	1395- 8506
V-150	USA 0A904646 - 0C239552	WH-35, 38	N.L.A.	1395- 6452	1395- 7824	1395- 7826
V-150	USA 0A904646 - 0C239552	WH-40, 48	N.L.A.	1395- 6452	1395- 7824	1395- 8506
V-150	USA 0C239553 - 0D081999	WMH-1, 7	810738	810749 2	1395-811690 1	1395-811691 2
V-150	USA 0D082000 - 0G303045	WMH-13, 13B, 23, 31	810738	810749 2	1395-811690 1	1395-811691 2
V-150	USA 0G303046 - 0G760299	WMV-2, 2A	810738	810749 3	1395-811690 1	1395-811691 3
V-150	USA 0G760300 and up	WMV-3A, 16, 16A	810738	810749 3	1395-811690 1	1395-811691 3
V-150 (XR4, MAG II)	USA 0B242885 - 0C100860	WH- 41A	N.L.A.	1395- 6452	1395- 7824	1395- 8506
V-150 (XR4, MAG II)	USA 0C100861 - 0C239552	WH-41	N.L.A.	1395- 6452	1395- 7824	1395- 8506
V-150 (XR4, MAG II)	USA 0C100861 - 0C239552	WH- 41A	N.L.A.	1395- 6452	1395- 7824	N.L.A.
V-150 (XR4, MAG II)	USA 0C239553 - 0D081999	WMH-6	810738	810749 2	1395-811690 1	1395-811691 2
V-150 (XR6, MAG III)	USA 0D082000 - 0G303045	WMH-14A, 25, 32A	810738	810749 2	1395-811690 1	1395-811691 2
V-150 (XR6, MAG III)	USA 0G303046 - 0G760299	WMV-3, 3A	810738	810749 3	1395-811690 1	1395-811691 3
V-150 (XR6, MAG III)	USA 0G762000 and up	WMV-3A, 16, 16A	810738	810749 3	1395-811690 1	1395-811691 3
V-175 (175, 1750)	USA 4301235 - 0C100860	WH-13	N.L.A.	1395- 6452	1395- 7824	1395- 7826
V-175 (175, 1750)	AUS 8058870 - 8064249	WH-13	N.L.A.	1395- 6452	1395- 7824	1395- 7826
V-175 (175, 1750)	USA 4301235 - 0C100860	WH-1, 4, 7, 28, 39, 46	N.L.A.	1395- 6452	1395- 7824	1395- 7826
V-175 (175, 1750)	AUS 8058870 - 8064249	WH-1, 4, 7, 28, 39, 46	N.L.A.	1395- 6452	1395- 7824	1395- 7826
V-175 (175, 1750)	USA 4301235 - 0C100860	WH-7A	N.L.A.	1395- 6452	1395- 7824	1395- 7826
V-175 (175, 1750)	AUS 8058870 - 8064249	WH-7A	N.L.A.	1395- 6452	1395- 7824	1395- 7826
V-175 (175, 1750)	USA 4301235 - 0C100860	WH-17	N.L.A.	1395- 6452	1395- 7824	1395- 7826
V-175 (175, 1750)	AUS 8058870 - 8064249	WH-17	N.L.A.	1395- 6452	1395- 7824	1395- 7826
V-175 (175, 1750)	USA 4301235 - 0C100860	WH-17R, 30, 34	N.L.A.	1395- 6452	1395- 7824	1395- 8506
V-175 (175, 1750)	AUS 8058870 - 8064249	WH-17R, 30, 34	N.L.A.	1395- 6452	1395- 7824	1395- 8506
V-175	USA 0C00861 - 0C239552	WH-34	N.L.A.	1395- 6452	1395- 7824	1395- 8506
V-175	USA 0C239553 - 0D081999	WMH-2, 11	810738	810749 2	1395-811690 1	1395-811691 2
V-175	USA 0D082000 - 0G303045	WMH-15, 22, 33	810738	810749 2	1395-811690 1	1395-811691 2
V-175	USA 0G303046 - 0G760299	WMV-4, 4A	810738	810749 3	1395-811690 1	1395-811691 3
V-175	USA 0G760300 and up	WMV-4A	810738	810749 3	1395-811690 1	1395-811691 3
V-200 (V-200,V-2000)	USA 4839034 - 0C100860	WH-3	N.L.A.	1395- 6452	1395- 7824	1395- 7826
V-200 (V-200,V-2000)	AUS 8061595 - 865672	WH-3	N.L.A.	1395- 6452	1395- 7824	1395- 7826
V-200 (V-200,V-2000)	USA 4839034 - 0C100860	WH-3A, 11	N.L.A.	1395- 6452	1395- 7824	1395- 7826
V-200 (V-200,V-2000)	AUS 8058870 - 8065672	WH-3A, 11	N.L.A.	1395- 6452	1395- 7824	1395- 7826
V-200 (V-200,V-2000)	USA 4839034 - 0C100860	WH-14, 16, 18, 20, 28, 39, 46	N.L.A.	1395- 6452	1395- 7824	1395- 7826
V-200 (V-200,V-2000)	AUS 8058870 - 8065672	WH-14, 16, 18, 20, 28, 39, 46	N.L.A.	1395- 6452	1395- 7824	1395- 7826
V-200	USA 0C100861 - 0C291519	WH-46	N.L.A.	1395- 6452	1395- 7824	1395- 7826
V-200	USA 0C291520 - 0D081999	WMH-3	810738	810749 2	1395-811690 1	1395-811691 2

**Not all parts listed are available for the European, C.I.S., Africa and Middle East Markets.  
For more information, please contact your local Mercury, Mariner, MerCruiser or Quicksilver Office.**

# FUEL SYSTEM

Model	Serial # Range	Carb #	Float	Gasket Kit	Inlet Needle Assy	Repair Kit
V-200	USA 0D082000 - 0G303045	WMH-16, 21, 34, 39	810738	810749 2	1395-811690 1	1395-811691 2
V-200	USA 0G303046 - 0G760299	WMV-5, 5A	810738	810749 3	1395-811690 1	1395-811691 3
V-200	USA 0G760300 and up	WMV-5A	810738	810749 3	1395-811690 1	1395-811691 3
V-225 (2.4L)	USA 5628028 and up	WH-5, 20	N.L.A.	1395- 6452	1395- 7824	1395- 7826
V-225 (3.0L)	USA 0D280813 - 0G303045	WMH-19, 46, 47	810738	810749 2	1395-811690 1	1395-811691 2
V-225 (3.0L)	USA 0G303046 - 0G760299	WMV-7, 13	810738	810749 3	1395-811690 1	1395-811691 3
V-225 (3.0L)	USA 0G303046 and up	WMV-13, 13A	810738	810749 3	1395-811690 1	1395-811691 3
V-225 (3.0L) SeaPro/ Marathon	USA 0G245605 - 0G303045	WMH-45	810738	810749 2	1395-811690 1	1395-811691 2
V-225 (3.0L) SeaPro/ Marathon	USA 0G303046 - 0G760299	WMH-6, 11A	810738	810749 3	1395-811690 1	1395-811691 3
V-225 (3.0L) SeaPro/ Marathon	USA All and up	WMV-11, 11A, 13, 13A, 19	810738	810749 3	1395-811690 1	1395-811691 3
V-250/V-275 (3.4L)	USA 0C101891 and up	WD-8A, 9, 9A	N.L.A.	N.L.A.	1395- 8318 1	N.L.A.
V-300 (3.4L)	USA 5611648 and up	WD-3, 5	N.L.A.	N.L.A.	1395- 8318 1	N.L.A.

## Early Mariner Carburetor Repair Kits

Model	SN Code	Serial # Range	Carburetor Repair Kit
2B	6A1	000101 - 037283	N.L.A.
2B	6A1	037284 - 131231	41859M
2B	6A1	131232 and up	N.L.A.
3.5 (M)	642	23741 and up	N.L.A.
3.5 (ML)	642	41691 and up	N.L.A.
5A (M)	661	30091 and up	N.L.A.
5A (ML)	661	46596 and up	N.L.A.
5C (M)	6E3	102151 - 144066	91755T
5C (ML)	6E3		91755T
5C (M)	6E3	144067 and up	14184T
5C (ML)	6E3	425197 and up	14184T
6C/D	6H8		11502M
6C/D	6H6		11502M
8B (M)	677	012921 and up	84473T
8B (ML)	677	316416 and up	84473T
8C	6G1		11502M
9.9C (M)	682		84473T
9.9C (ML)	682		84473T
9.9C (E)	682		84473T
9.9C (EL)	682		84473T
9.9C (M)	682	070796 and up	814481M
9.9C (ML)	682	368040 and up	814481M
9.9C (E)	682	251511 and up	814481M
9.9C (EL)	682	554146 and up	814481M
15C (M)	684		84473T
15C (ML)	684	332301 - 332301	84473T
15C (E)	684		84473T
15C (EL)	684		84473T
15C (M)	684	052848 and up	814481M
15C (ML)	684	332302 and up	814481M
15C (E)	684	252381 and up	814481M
15C (EL)	684	553251 and up	814481M
20A (M)	653	07616 and up	N.L.A.
20A (ML)	653	37211 and up	N.L.A.
20C	6A9		84473T
25A (M)	648	24991 and up	N.L.A.
25A (ML)	648	64046 and up	N.L.A.

Model	SN Code	Serial # Range	Carburetor Repair Kit
25A (E)	648	27056 and up	N.L.A.
25A (EL)	648	56526 and up	N.L.A.
25C	695		811038M
28 (M)	664	05306 and up	N.L.A.
28 (ML)	664	41686 and up	N.L.A.
28 (E)	664	26236 and up	N.L.A.
28 (EL)	664	57421 and up	N.L.A.
30A (M)	689	230100 and up	811038M
30A (ML)	689	530100 and up	811038M
30A (E)	689	250100 and up	811038M
30A (EL)	689	550100 and up	811038M
40A (M) (Above Prop Exhaust)	676		N.L.A.
40A (ML) (Above Prop Exhaust)	676		N.L.A.
40A (E) (Above Prop Exhaust)	676		N.L.A.
40A (EL) (Above Prop Exhaust)	676		N.L.A.
40A (M) (Above Prop Exhaust)	676	A007736 and up	94500M
40A (ML) (Above Prop Exhaust)	676	A311371 and up	94500M
40A (E) (Above Prop Exhaust)	676	A100416 and up	94500M
40A (EL) (Above Prop Exhaust)	676	A403471 and up	94500M
40B (M) (Thru Prop Exhaust)	676		N.L.A.
40B (ML) (Thru Prop Exhaust)	676		N.L.A.
40B (E) (Thru Prop Exhaust)	676		N.L.A.
40B (EL) (Thru Prop Exhaust)	676		N.L.A.
40B (M) (Thru Prop Exhaust)	676	B002781 and up	94500M
40B (ML) (Thru Prop Exhaust)	676	B302426 and up	94500M
40B (E) (Thru Prop Exhaust)	676	B102786 and up	94500M
40B (EL) (Thru Prop Exhaust)	676	B405251 and up	94500M
40/40C (M)	6E9		97667T
40/40C (ML)	6E9		97667T
40/40C (E)	6E9		97667T
40/40C (EL)	6E9		97667T
40/40C (M)	6E9	007666 and up	17068M
40/40C (ML)	6E9	309344 and up	17068M
40/40C (E)	6E9	105014 and up	17068M
40/40C (EL)	6E9	423163 and up	17068M
48 (M)	670	02641 and up	84419M
48 (ML)	670	34581 and up	84419M
W48 (M)	670		84419M
W48 (ML)	670		84419M
W48 (M)	670	007191 and up	N.L.A.

Model	SN Code	Serial # Range	Carburetor Repair Kit
W48 (ML)	670	334241 and up	N.L.A.
55 (E)	663		84419M
55 (EL)	663		84419M
55 (E)	663	004424 and up	N.L.A.
55 (EL)	663	318399 and up	N.L.A.
W55	663		N.L.A.
60	675		84419M
60	6F0		N.L.A.

**COOLING SYSTEM**

**COOLING SYSTEM**

**OUTBOARD WATER PUMP KITS - COMPLETE**

**COMPLETE WATER PUMP**



**46- 42089A 5**

Includes both upper & lower housings, gaskets, plate and impeller.  
Fits 6-15 hp. outboards. See chart for specific engine applications.

**COMPLETE WATER PUMP**

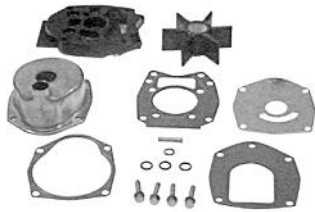

**46- 43024A 7**

Includes both upper & lower housings, gaskets, plate and impeller.  
Fits various outboard models, 40-125 hp. See chart for specific engine applications.

**COMPLETE WATER PUMP**



**46- 43024A09**

**WATER PUMP BASE ASSEMBLY**



**46- 46893A 6**

Includes both upper & lower housings, gaskets, plate and impeller.  
Fits various outboards 3.9-9.8(model 110). See chart for specific engine applications.

**COMPLETE WATER PUMP**



**46- 48744A 3**

Includes both upper & lower housings, gaskets, plate and impeller.  
Fits a 20 hp (model 200) outboard, 1970-1985. See chart for serial number groupings.

**COMPLETE WATER PUMP**



**46- 70941A 3**

Includes both upper & lower housings, gaskets, plate and impeller.  
Fits the model 45/4.5 hp. and 4 hp., 1 cylinder outboards with a .456" I.D. water impeller.

**COMPLETE WATER PUMP**



**46- 73640A 2**

Includes both upper & lower housings, gaskets, plate and impeller.  
Fits a 70 hp. (3 cylinder) outboard. See chart for specific serial number groupings.

**COMPLETE WATER PUMP**



**46- 77177A 3**

Includes both upper & lower housings, gaskets, plate and impeller.  
 Fits 30 JET (USA 0C159200-0G589999)  
 35 hp. 2-cycle (2 cylinder)  
 40 hp. 2-cycle (USA 4860103 thru MY1983, AUS 8052125 & above, BEL 9184451 thru MY1983, CAN 7112423 & above)  
 45 hp. 2-cycle (4 cylinder)  
 50 hp. 2-cycle (4 cylinder) (USA 5531630 & above, AUS 8063985 & above, BEL 9248006 & above, CAN 7143688 & above)  
 50/60 2-cycle (3 cylinder) (USA 6428681-0D000749, BEL 9385911-9683054, CAN 7208333 & above)  
 70 hp. 2-cycle (3 cylinder) (USA 4977157-6428680, AUS 8050200 & above, BEL 9196961-9385910, CAN 7110998-7208332).

**COMPLETE WATER PUMP**



**46- 77516A 3**

Includes both upper & lower housings, gaskets, plate and impeller.  
 Fits various Mercury 35/40/50/65 hp outboard engines prior to 1976. See application chart for specific serial number breakdowns.

**COMPLETE WATER PUMP**



**46-803750A03**

Fits Mercury/Mariner 8/9.9 hp. FourStroke outboards (non-BigFoot), beginning with Model Year 2005.

**COMPLETE WATER PUMP**



**46-812966A11**

Includes both upper & lower housings plus the pictured gaskets, plate and impeller.  
 Fits 45 JET/ 50/55/60 hp outboards. See chart for specific engine applications.

**COMPLETE WATER PUMP**



**46-812966A12**

Includes both upper and lower housings, gaskets, key, O-ring, plate, and impeller  
 Fits various outboard models, 30-60 hp EFI and Carbureted FourStrokes. See chart for specific engine applications.

**COMPLETE WATER PUMP**



**817275A 5**

Includes both upper & lower housings, gaskets, plate and impeller.  
 Fits 3.0L DFI outboards. See chart for specific engine applications.

**COMPLETE WATER PUMP**



**817275A 6**

Includes both upper & lower housings, gaskets, plate and impeller.  
 Fits 3.0L DFI outboards. See chart for specific engine applications.

# COOLING SYSTEM

## COMPLETE WATER PUMP



**817275A09**

Includes both upper and lower housings, gaskets, seals, key, Oil-carrier, retaining ring, plate, and impeller.

135-300 hp FourStroke Verado (4 and 6 cylinder)

3.0L DFI and EFI outboards. See chart for specific engine applications.

## COMPLETE WATER PUMP

Image not Available.

**8M0078858**

Includes water impeller, upper and lower housings, face plate, gaskets, drive key, face seal and water tube coupling.

**8M0094529**

Includes upper and lower housings, gaskets, plate, seals, key and impeller.

Fits 150 EFI FourStroke 1B905505 and Up, 75-115 EFI FourStroke 2B094996 and Up

## OUTBOARD WATER PUMP UPPER REPAIR KITS

### WATER PUMP UPPER REPAIR KIT



**46- 99157T 2**

Includes upper housing, seals, gaskets, face plate, key and impeller.

See chart for specific engine applications.

### WATER PUMP UPPER REPAIR KIT



**46- 60366T 1**

Priced individually, sold @ multiples of 2

Mercury Branded, Clamshell Package Point of Sale Packaged.

## WATER PUMP UPPER REPAIR KIT



**817275A08**

## WATER PUMP UPPER REPAIR KIT

Image not Available.

**8M0061040**

Includes the upper housing, new impeller , face plate, gaskets and key.

Fits the F150 EFI FourStroke outboard (s/n USA 1B905505 and newer) and the F75-115 1.7L FourStroke outboard (s/n USA 2B094996 and newer).

## OUTBOARD WATER PUMP IMPELLER - MERCURY/MARINER

### WATER PUMP IMPELLER



**47- 16154 1**

### WATER PUMP IMPELLER



**47- 16154 3**

Fits Mercury/Mariner shifttable 3.3 hp. (MY1993 & newer), 4/5 hp. 2-cycle (MY1987 & newer), and the 4/5/6 hp. FourStroke (MY1999 & newer).

**WATER PUMP IMPELLER**



**47- 19453T**

**WATER PUMP IMPELLER**



**47- 22748**

**WATER PUMP IMPELLER**



**47- 42038Q02**

Fits 6-15 hp. 2-cycle outboards with standard gearcases (USA 0A197112 & above, BEL 9461526 & above), fits 8/9.9 hp. FourStroke outboards (2004 and prior) with standard gearcases, and fits 15 hp. FourStroke outboards (323cc, MY2008 and prior) with standard gearcases.

Priced individually, sold @ multiples of 2

Quicksilver Branded, Clamshell Package Point of Sale Packaged.

**WATER PUMP IMPELLER**



**47- 43026T 2**

Fits 30/40/45/50/60 FourStroke Bigfoot, 60 (3 cyl.) BigFoot, 75-125 (all 3 & 4 cylinder models, USA A996142 & above and BEL 9483121 & above), 75/90/115 FourStroke, 150 EFI FourStroke, V-200 (3.0L) DFI, V-225/250 (3.0L) and MerCruiser Alpha One Gen II drives.

**WATER PUMP IMPELLER**



**47- 85089 10**

Included in kit 47-85089T 7

Fits various 15 thru 25 hp outboards. See chart for specific engine applications.

**WATER PUMP IMPELLER**



**47- 85647**

Included in kit 47-85647T 1

Fits 3.4L outboards.

**WATER PUMP IMPELLER**



**47- 89980**

Included in kit 47-89980T 1.

Fits various outboards 3.5-9.8(model 110). See chart for specific engine applications.

**WATER PUMP IMPELLER**

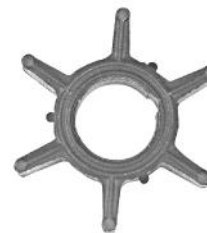

**47- 89981**

Included in kit 47-89981T 2

Fits various outboards 3.9-9.8(model 110). See chart for specific engine applications.

# COOLING SYSTEM

## WATER PUMP IMPELLER



**47- 89982**

Included in kit 47-89982T 1  
Fits a 20 hp (model 200) outboard, 1970-1985. See chart for serial number groupings.

## WATER PUMP IMPELLER



**47- 89983T**

Included in kit 47-89983T 2  
Fits various 30-70 hp outboards. See chart for specific engine applications.

## WATER PUMP IMPELLER



**47- 89984T 3**

Fiberglass Insert for improved corrosion resistance in salt water.  
Fits MCM & Outboard applications

## WATER PUMP IMPELLER



**47- 89984T 4**

Fits MCM & Outboard applications. This impeller uses a brass insert. An alternate glass insert impeller 47-89984T3 is available for increased corrosion protection in salt water applications.

## WATER IMPELLER REPAIR KIT



**47- 89984T 5**

Includes new impeller, face plate w/ face plate gaskets, drive key or pin, water tube guide sleeve, "O" rings and gearlube fill & vent screw seals.  
Fits Mercury/Mariner 65 hp (4 cylinder) through V-6 outboards with short-vane impellers and fits MerCruiser I/R/MR/Alpha drives (s/n 2495186-0D469858).  
Mercury Branded, Clamshell Package Point of Sale Packaged.

## WATER PUMP IMPELLER



**47- 95289 2**

## WATER PUMP IMPELLER



**47-803748**

Fits 9.9 hp. FourStroke (BigFoot gearcase), beginning with Model Year 2005.

## WATER PUMP IMPELLER



**47-803748 1**

Fits Mercury/Mariner 8/9.9 hp. FourStroke outboards (standard gearcase), beginning with Model Year 2005.



**WATER PUMP IMPELLER**



47-888689

**WATER PUMP IMPELLER**



47-F84065

**OUTBOARD WATER PUMP IMPELLER - FORCE**

**WATER PUMP IMPELLER**



47- 89984T 3

Fiberglass Insert for improved corrosion resistance in salt water.  
Fits MCM & Outboard applications

**OUTBOARD WATER PUMP IMPELLER - EARLY MARINER**

**IMPELLER**

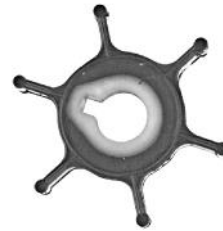

47- 80395M

**WATER PUMP IMPELLER**



47-F436065-2

**IMPELLER**



47- 96305M

**WATER PUMP IMPELLER**



47-F462065

**IMPELLER**



47- 11590M

**COOLING SYSTEM**

**IMPELLER**



47- 95611M

**IMPELLER**



47- 99971M

**IMPELLER**



47- 84027T

**IMPELLER**



47- 81423M

**WATER PUMP IMPELLER**



47- 95533M

**WATER PUMP IMPELLER**



47- 97108M

**IMPELLER**



47- 84797M

**OUTBOARD WATER IMPELLER REPAIR KITS - MERCURY/MARINER**

**WATER IMPELLER REPAIR KIT**



16159A03

**WATER IMPELLER REPAIR KIT**



**8M0080264**

**WATER IMPELLER REPAIR KIT**



**47- 19453T 2**

Includes new impeller, drive key, face plate with gaskets & water tube seal.  
Fits 50 hp (3 cylinder) 2-cycle, 0D000750-0G589999 with standard gearcase only, and also fits 55/60 hp (3 cylinder) 2-cycle, 0D000750 and above with standard gearcase only.  
Mercury Branded, Clamshell Package Point of Sale Packaged.

**WATER IMPELLER REPAIR KIT**



**47- 42038T 3**

Includes new impeller, face plate, drive key, plate gasket and water tube guide.  
Fits 6-15 hp. outboards. See chart for specific engine applications.  
Mercury Branded, Clamshell Package Point of Sale Packaged.

**WATER PUMP IMPELLER REPAIR KIT**

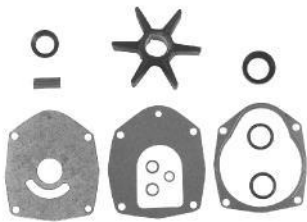

**47- 43026K06**

Fits 40/45/50/60 FourStroke Bigfoot, 60 (3 cyl.) BigFoot, 75-125 (all 3 & 4 cylinder models having pump cover screws without insulators, USA 0A996142 & above and BEL 9483121 & above), 75/90/115 (1.7L and prior) FourStroke, V-200/225/250 (3.0L), Verado 4.80 dia. torpedo gearcases and MerCruiser Alpha One Gen II drives.  
Mercury Branded, Clamshell Package Point of Sale Packaged.

**WATER IMPELLER REPAIR KIT**



**47- 85089T 4**

Includes new impeller, face plate, drive key, plate gasket, O ring & impeller washers.  
Fits various 15 thru 25 hp 2 cycle outboards. See chart for specific engine applications.  
Mercury Branded, Clamshell Package Point of Sale Packaged.

**WATER IMPELLER REPAIR KIT**



**47- 89980T 1**

Includes new impeller, face plate, O rings, drive key, slinger and guide sleeve.  
Fits various outboards 3.5-9.8(model 110). See chart for specific engine applications.

**WATER IMPELLER REPAIR KIT**



**47- 89981T 1**

Includes new impeller, face plate, "O" rings, drive key, slinger and guide sleeve.  
Fits Mercury/Mariner 4 HP (1 cylinder), Model 75 (7.5 HP and Model 110/9.8 HP when the water impeller ID measures .456 inches.  
Mercury Branded, Clamshell Package Point of Sale Packaged.

**WATER IMPELLER REPAIR KIT**



**47- 89982T 1**

Includes new impeller, face plate, plate gaskets, slinger, drive key and O rings.  
Fits a 20 hp (model 200) outboard, 1970-1985. See chart for serial number groupings.

# COOLING SYSTEM

## WATER IMPELLER REPAIR KIT



### 47- 89983T 1

Includes new impeller, drive key, face plate with gaskets, "O" rings and seat assemblies.

Fits 30 JET (USA 0C159200-0G589999)  
 35 hp. 2-cycle (USA 6445653 & above, BEL 9384476 & above, CAN 7209608 & above)  
 40 hp. 2-cycle (all 2 cylinder through MY 1983)  
 40 hp. 2-cycle (4 cylinder) (USA 0C159200 & above, BEL 9570790 & above)  
 45 hp. 2-cycle (4 cylinder)  
 50 hp. 2-cycle (4 cylinder with plastic water pumps)  
 50/60 hp. 2-cycle (3 cylinder) (USA 6428681-0D000749, BEL 9385911-9683054, CAN 7208333 & above)  
 70 hp. 2-cycle (3 cylinder) (USA 4977157-6428680, AUS 8050200 & above, BEL 9196961-9385910, CAN 7110998-7208332).  
 Mercury Branded, Clamshell Package Point of Sale Packaged.

## WATER IMPELLER REPAIR KIT



### 47- 89984T 5

Includes new impeller, face plate w/ face plate gaskets, drive key or pin, water tube guide sleeve, "O" rings and gearlube fill & vent screw seals.

Fits Mercury/Mariner 65 hp (4 cylinder) through V-6 outboards with short-vane impellers and fits MerCruiser I/R/MR/Alpha drives (s/n 2495186-0D469858).  
 Mercury Branded, Clamshell Package Point of Sale Packaged.

## WATER IMPELLER REPAIR KIT



### 821354A 2

Includes new impeller, drive key, face plate with gaskets & water tube seal.  
 Fits 40/45/50 (4-Stroke) outboards. See chart for specific engine applications.

## IMPELLER REPAIR KIT



### 821354A04

## WATER IMPELLER REPAIR KIT



### 47-803748K01

Includes new impeller and face plate.  
 Fits Mercury/Mariner 8/9.9 hp. FourStroke outboards (standard gearcase), beginning with Model Year 2005.  
 Mercury Branded, Clamshell Package Point of Sale Packaged.

## WATER IMPELLER REPAIR KIT



### 47-803748K02

Includes new impeller and face plate.  
 Fits 9.9 hp. FourStroke (BigFoot gearcase), beginning with Model Year 2005.  
 Mercury Branded, Clamshell Package Point of Sale Packaged.

## WATER IMPELLER REPAIR KIT



### 853792T01

Fits Mercury/Mariner Belgium 2-cycle, 2 cylinder/430cc outboards, 25hp. 0N018456 and above and 30hp. 0N001875 and above.

**IMPELLER REPAIR KIT**

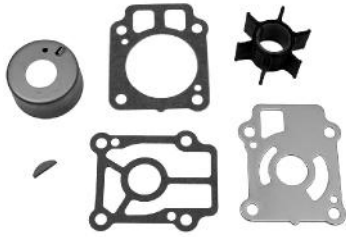

**853792A07**

Fits the F25/30 EFI FourStroke outboards.

**WATER IMPELLER REPAIR KIT**

Image not Available.

**8M0094530**

Includes the new impeller , face plate, gaskets and key.  
Fits the F150 EFI FourStroke outboard (s/n USA 1B905505 and newer) and the F75-115 1.7L FourStroke outboard (s/n USA 2B094996 and newer).

**OUTBOARD WATER IMPELLER REPAIR KITS - EARLY MARINER**

**REPAIR KIT**



**814453M**

**REPAIR KIT**



**96325T**

**REPAIR KIT**



**11656T**

**REPAIR KIT**



**84181T**

**REPAIR KIT**

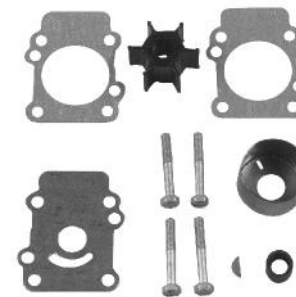

**46-84277T**

**REPAIR KIT**

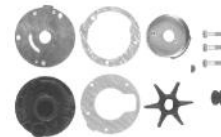

**97793T**

**COOLING SYSTEM**

**REPAIR KIT**

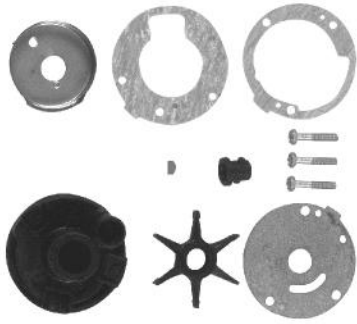

42431M

**REPAIR KIT**



95661T

**REPAIR KIT**



84363T

**REPAIR KIT**



84188T

**OUTBOARD WATER PUMP UPPER HOUSINGS**

**UPPER HOUSING**



14334A 3

**UPPER HOUSING**



46- 16156

**UPPER HOUSING**



46- 16156 1

**UPPER HOUSING**



46- 16156 2

**COVER ASSEMBLY**



20270A 2

**COVER ASSEMBLY**



46- 42089A 2

**UPPER HOUSING**



46- 77822A 1

**COVER ASSEMBLY**



93224A 1

**WATER PUMP UPPER HOUSING**



46- 96148T 1

**UPPER HOUSING**



46- 99157A02

**UPPER HOUSING**



46-803750A05

Contains both the upper housing and liner.  
Fits Mercury/Mariner outboards, the F8/9.9 hp. FourStroke BigFoot models (209 cc., Model Year 2005 and above), F15/20 FourStroke outboards (0R235168 and above), and 9.9 hp. 2-cycle outboards (0N059858 and above) and 15/18 hp. 2-cycle outboards (0N001590 and above).

**UPPER HOUSING**



46-803750A02

Fits Mercury/Mariner 8/9.9 hp. FourStroke outboards (standard gearcase), beginning with Model Year 2005.



# COOLING SYSTEM

## UPPER HOUSING



46-803750T05

## UPPER HOUSING



817275A 2

## UPPER HOUSING



817275A 1

## UPPER HOUSING



46-821351A 3

## UPPER HOUSING



817275A10

## UPPER HOUSING



888686T

# WATER PUMP REPAIR CHARTS

## FourStroke Water Pump Repair Kits

Model	Model Notes	Serial # Range	Complete Pump Kit	Upper Kit	Impeller	Impeller Repair Kit	Upper Housing
2.5 FourStroke		JPN 0R131842 and up	N/A	N/A	47- 16154 3	889246A16	16156A01
3.5 FourStroke		JPN 0R131842 and up	N/A	N/A	47- 16154 3	889246A16	16156A01
4 FourStroke		JPN 0R000001 and up	N/A	N/A	47- 16154 3	16159A03	46- 16156
		BEL 0P073456 and up					
5 FourStroke		JPN 0R000001 and up	N/A	N/A	47- 16154 3	16159A03	46- 16156
		BEL 0P073456 and up					
6 FourStroke		JPN 0R000001 and up	N/A	N/A	47- 16154 3	16159A03	46- 16156
		BEL 0P073456 and up					
8 FourStroke	232cc	USA 0G760300 - 0T178499	46- 42089A 5	N/A	47- 42038Q02	47- 42038Q 3	46- 42089A 2
	232cc	USA 0H017100 - 0H017349					
8 FourStroke	323cc, Standard	BEL 0P075166 - 0P325499	46- 42089A 5	N/A	47- 42038Q02	47- 42038Q 3	46- 42089A 2
8 FourStroke		USA 0R042475 and up	46-803750A03	N/A	47-803748 1	47-803748Q01	46-803750A02(2)
		BEL 0P325500 and up					
9.9 FourStroke	232cc	USA 0H000058 - 0H016909	46- 42089A 5	N/A	47- 42038Q02	47- 42038Q 3	46- 42089A 2



# COOLING SYSTEM

Model	Model Notes	Serial # Range	Complete Pump Kit	Upper Kit	Impeller	Impeller Repair Kit	Upper Housing
9.9 FourStroke	323cc, Standard	USA 0G760300 - 0T979999	46- 42089A 5	N/A	47- 42038Q02	47- 42038Q 3	46- 42089A 2
	323cc, Standard	BEL 0P075166 - 0P325499					
9.9 FourStroke	323cc, BigFoot	USA 0G760300 - 0T979999	N/A	46- 99157T 2	47- 85089 10	N/A	46- 99157A02
	323cc, BigFoot	BEL 0P075166 - 0P325499					
9.9 FourStroke	Standard gearcase	JPN 0R042475 and up	46-803750A03	N/A	47-803748 1	47-803748Q01	46-803750A02
		BEL 0P325500 and up					
9.9 FourStroke	BigFoot gearcase	JPN 0R042475 and up	N/A	N/A	47-803748	47-803748Q02	46-803750A05(2)
		BEL 0P325500 and up					
15 FourStroke	323cc, Standard	USA 0G590000 - 1B727495	46- 42089A 5	N/A	47- 42038Q02	47- 42038Q 3	46- 42089A 2
		BEL 9973100 and up					
15 FourStroke	323cc, BigFoot	USA 0G590000 - 1B727495	N/A	46- 99157T 2	47- 85089 10	N/A	46- 99157A02
		BEL 9973100 and up					
15 FourStroke	351cc	JPN 0R235949 and up	46-803750A06	N/A	47-803748	N/A	46-803750A05
20 FourStroke	351cc	JPN 0R235168 and up	46-803750A06	N/A	47-803748	N/A	46-803750A05
25 FourStroke	Carb	USA 0G590000 - 0T408999	N/A	N/A	47- 85089 10	821354A 2	46-821351A 3
		BEL 9973100 - 0P153499					
25 FourStroke	Carb	USA 0T409000 - 1B344298	N/A	N/A	47- 85089 10	821354A04	46-821351A 3
		BEL 0P153500 - 0P388282					
25 FourStroke	EFI	JPN 0R106999 and up	N/A	N/A	47- 16154 1	853792A07	46-803750T05
30 FourStroke	Carb, Standard	USA 0G760300 - 0T408999	N/A	N/A	47- 85089 10	821354A 2	46-821351A 3
		BEL 0P153500 - 0P153499					
30 FourStroke	Carb, Standard	USA 0T409000 and up	N/A	N/A	47- 85089 10	821354A04	46-821351A 3
		BEL 0P153500 and up					
30 FourStroke	EFI	USA 0T409000 - 1B226999	N/A	N/A	47- 85089 10	821354A04	46-821351A 3
30 FourStroke	EFI	JPN 0R106999 and up	N/A	N/A	47- 16154 1	853792A07	46-803750T05
40 FourStroke	Carb, 3 cylinder, Standard	USA 0G760300 - 0T408999	N/A	N/A	47- 85089 10	821354A 2	46-821351A 3
		BEL 0P153500 - 0P153499					
40 FourStroke	Carb, 3 cylinder, Standard	USA 0T409000 and up	N/A	N/A	47- 85089 10	821354A04	46-821351A 3
		BEL 0P153500 and up					
40 FourStroke	EFI, 3 cylinder, Standard	USA 0T409000 - 1B226999	N/A	N/A	47- 85089 10	821354A04	46-821351A 3
40 FourStroke	EFI, 3 cyl., Short Shaft	USA 1B227000 - 1B344398	N/A	N/A	47- 85089 10	821354A04	46-821351A 3
40 FourStroke	EFI, 3cyl., Short Shaft	CHN 1C000001 - 1C049738	N/A	N/A	47- 85089 10	821354A04	46-821351A 3
40 FourStroke	EFI, 3cyl., Long Shaft	CHN 1C000001 - 1C049738	46-812966A12	N/A	47- 19453T	N/A	14334A 3
40 FourStroke	EFI, 3 cyl.	CHN 1C049739 and up	46-812966A12	N/A	47- 19453T	N/A	14334A 3
40 FourStroke	Carb, 4 cylinder, BigFoot	USA 0T228405 - 0T598999	46- 43024A09	N/A	47- 43026T 2	47- 43026K06	817275A 2
		BEL 0P094500 - 0P206999					
40 FourStroke	EFI, 4 cylinder, BigFoot	USA 0T409000 - 1B344398	46- 43024A09	N/A	47- 43026T 2	47- 43026K06	817275A 2
		BEL 0P153500 - 0P400999					
		CHN 1C000001 - 1C033810					
40 FourStroke	EFI, 4 cylinder, BigFoot	CHN 1C033811 - 1C050251	46- 43024A 7	N/A	47- 43026T 2	47- 43026K06	817275A 2
		BEL 0P401000 - 0P515896					
40 FourStroke	EFI, 4 cylinder, BigFoot	CHN 1C050252 and up	46- 43024A09	N/A	47- 43026T 2	47- 43026K06	817275 2
45 FourStroke	4 cylinder Bodensee, Standard	USA 0G231123 - 0T178499	N/A	N/A	47- 85089 10	821354A 2	46-821351A 3
45 FourStroke	4 cylinder, Bodensee, BigFoot	USA 0G231123 - 0T178499	46- 43024A 7	N/A	47- 43026T 2	47- 43026K06	817275A 2
50 FourStroke	Standard	USA 0G231123 - 0T178499	N/A	N/A	47- 85089 10	821354A 2	46-821351A 3
50 FourStroke	BigFoot	USA 0G231123 - 0T178499	46- 43024A 7	N/A	47- 43026T 2	47- 43026K06	817275A 2
50 FourStroke	Carb, Standard, 996cc	USA 0T178500 - 0T598999	46-812966A12	N/A	47- 19453T	N/A	14334A 3
		BEL 0P094500 - 0P206999					
50 FourStroke	Carb, BigFoot, 996cc	USA 0T178500 - 0T598999	46- 43024A09	N/A	47- 43026T 2	47- 43026K06	817275A 2
		BEL 0P094500 - 0P206999					
50 FourStroke	EFI, Standard, 996cc	USA 0T409000 - 1B344398	46-812966A12	N/A	47- 19453T	N/A	14334A 3
		BEL 0P153500 - 0P400999					
		CHN 1C000001 and up					

Not all parts listed are available for the European, C.I.S., Africa and Middle East Markets.  
 For more information, please contact your local Mercury, Mariner, MerCruiser or Quicksilver Office.

# COOLING SYSTEM

Model	Model Notes	Serial # Range	Complete Pump Kit	Upper Kit	Impeller	Impeller Repair Kit	Upper Housing
50 FourStroke	EFI, BigFoot, 996cc	USA 0T409000 - 1B344398	46-43024A09	N/A	47-43026T 2	47-43026K06	817275A 2
		BEL 0P153500 - 0P400999					
		CHN 1C000001 - 1C033810					
50 FourStroke	EFI, BigFoot, 996cc	CHN 1C033811 - 1C050251	46-43024A 7	N/A	47-43026T 2	47-43026K06	817275A 2
		BEL 0P401000 - 0P515896					
50 FourStroke	EFI, BigFoot, 996cc	CHN 1C050252 and up	46-43024A09	N/A	47-43026T 2	47-43026K06	817275A 2
60 FourStroke	Carb, Standard, 996cc	USA 0T178500 - 0T598999	46-812966A12	N/A	47-19453T	N/A	14334A 3
		BEL 0P094500 - 0P206999					
60 FourStroke	Carb, BigFoot, 996cc	USA 0T178500 - 0T598999	46-43024A09	N/A	47-43026T 2	47-43026K06	817275A 2
		BEL 0P094500 - 0P206999					
60 FourStroke	EFI, Standard, 996cc	USA 0T409000 - 1B344398	46-812966A12	N/A	47-19453T	N/A	14334A 3
		BEL 0P153500 and up					
		CHN 1C000001 and up					
60 FourStroke	EFI, BigFoot, 996cc	USA 0T409000 - 1B344398	46-43024A09	N/A	47-43026T 2	47-43026K06	817275A 2
		BEL 0P153500 - 0P400999					
		CHN 1C000001 - 1C033810					
60 FourStroke	EFI, BigFoot, 996cc	CHN 1C033811 - 1C050251	46-43024A 7	N/A	47-43026T 2	47-43026K06	817275A 2
		BEL 0P401000 - 0P515896					
60 FourStroke	EFI, BigFoot, 996cc	CHN 1C050252 and up	46-43024A09	N/A	47-43026T 2	47-43026K06	817275A 2
75 FourStroke	1596cc	USA 0G960500 - 1B366822	46-43024A 7	N/A	47-43026T 2	47-43026K06	817275A 2
75 FourStroke	1731cc	USA 1B366823 - 2B094995	46-43024A 7	N/A	47-43026T 2	47-43026K06	817275A 2
		BEL 0P459572 and up					
75/80 FourStroke	2.1L	USA 2B094996 and up	8M0094529	8M0061040	47-43026T 2	8M0094530	817275A10
90 FourStroke	1596cc	USA 0G960500 - 1B366822	46-43024A 7	N/A	47-43026T 2	47-43026K06	817275A 2
90 FourStroke	1731cc	USA 1B366823 - 2B094995	46-43024A 7	N/A	47-43026T 2	47-43026K06	817275A 2
		BEL 0P459572 and up					
90/100 FourStroke	2.1L	USA 2B094996 and up	8M0094529	8M0061040	47-43026T 2	8M0094530	817275A10
115 FourStroke	1741cc	USA 0T178500 - 1B366822	46-43024A 7	N/A	47-43026T 2	47-43026K06	817275A 2
115 FourStroke	1731cc	USA 1B366823 - 2B094995	46-43024A 7	N/A	47-43026T 2	47-43026K06	817275A 2
115 FourStroke	2.1L	USA 2B094996 and up	8M0094529	8M0061040	47-43026T 2	8M0094530	817275A10
135 FourStroke	4 cyl., Verado	USA 1B227000 and up	817275A09	817275A08	47-43026T 2	47-43026K06	817275A 2
150 FourStroke	EFI	USA 1B905505 and up	8M0094529		47-43026T 2		817275A10
150 FourStroke	4 cyl., Verado	USA 1B227000 and up	817275A09	817275A08	47-43026T 2	47-43026K06	817275A 2
175 FourStroke	4 cyl., Verado	USA 1B227000 and up	817275A09	817275A08	47-43026T 2	47-43026K06	817275A 2
200 FourStroke	4 cyl., Verado	USA 1B517159 and up	817275A09	817275A08	47-43026T 2	47-43026K06	817275A 2
200, 6 cyl., Verado	4.8 inch Torpedo	USA 0T980000 and up	817275A09	817275A08	47-43026T 2	47-43026K06	817275A 2
	5.44 inch Torpedo		8M0078858		47-43026T 2		817275A 1
225 FourStroke	EFI	USA 0T653945 and up	N/A	N/A	47-888689	888687A 1	888686T
225, 6 cyl., Verado	4.8 inch Torpedo	USA 0T980000 and up	817275A09	817275A08	47-43026T 2	47-43026K06	817275A 2
	5.44 inch Torpedo		8M0078858		47-43026T 2		817275A 1
250, 6 cyl., Verado	4.8 inch Torpedo	USA 0T980000 and up	817275A09	817275A08	47-43026T 2	47-43026K06	817275A 2
	5.44 inch Torpedo		8M0078858		47-43026T 2		817275A 1
275, 6 cyl., Verado	4.8 inch Torpedo	USA 0T980000 and up	817275A09	817275A08	47-43026T 2	47-43026K06	817275A 2
	5.44 inch Torpedo		8M0078858		47-43026T 2		817275A 1
300, 6 cyl., Verado	4.8 inch Torpedo	USA 1B517434 and up	817275A09	817275A08	47-43026T 2	47-43026K06	817275A 2
	5.44 inch Torpedo		8M0078858		47-43026T 2		817275A 1

(1) Base Housing only, seal not included.

(2) Upper Housing only, insert cup not included.

**2-Cycle Water Pump Repair Kits**

Model	Serial # Range	Complete Pump Kit	Upper Kit	Impeller	Impeller Repair Kit	Upper Housing
2 hp (pump on top of gearcase)	0G413201 and up			N.L.A.		
2.2M	8075603 and up			47- 95289 2		
2.5/3 hp	0A855097 and up			47- 95289 2		
3.3 w/shift	0D901217 and up			47- 16154 3	8M0080264	46- 16156 1
3.3 non-shift	0D901217 and up			47- 95289 2		
3.5	6202173 and up	N.L.A.		47- 89980		N.L.A.
3.6	USA 5404657 and up BEL 9252831 and up CAN 7145388 and up	N.L.A.		47- 89980		N.L.A.
3.9(14)	1655013 - 2200317 2200318 - 2498135	46- 46893A 6	N/A	47- 22748	N/A	N.L.A.
4 (1 Cyl.) .438 inch Imp. I.D.	USA 5595532 - 0A809600 AUS 8068065 and up BEL 9258281 - 9477829 CAN 7143688 and up	N.L.A.	N/A	47- 89980	47- 89980T 1	93224A 1
4 (1 Cyl.) .456 inch Imp. I.D.	USA 5595532 and up AUS 8068065 and up BEL 9258281 and up CAN 7143688 and up	46- 70941A 3	N/A	47- 89981	47- 89981T 1	93224A 1
4/5 (1 Cyl.)	USA 0A809601 and up BEL 9477830 and up	N/A	N/A	47- 16154 3	N/A	46- 16156
40/4 (2 Cyl.), GNAT, .438 inch Imp. I.D.	BEL 9075839 - 9256980 CAN 7085673 - 7146487	N.L.A.	N/A	47- 89980	N/A	N.L.A.
40/4 (2 Cyl.), GNAT, .456 inch Imp. I.D.	BEL 9075839 - 9256980 CAN 7085673 - 7146487	N.L.A.	N/A	47- 89981	N/A	N.L.A.
40/4 (2 Cyl.)	USA 5589202 and up AUS 8065265 and up BEL 9256981 and up CAN 7146488 and up	N.L.A.	N/A	47- 89980	N/A	N.L.A.
45/4.5 (1 Cyl)	USA 4107220 - 5595531 AUS 8026540 - 8068064 BEL 9072179 - 9258280 CAN 7045758 - 7147237	46- 70941A 3	N/A	47- 89981	47- 89981T 1	93224A 1
45/4.5 (1 Cyl), .438 inch Imp. I.D.	USA 5595532 and up AUS 8068065 and up BEL 9258281 and up CAN 7147238 and up	N.L.A.	N/A	47- 89980	47- 89980T 1	93224A 1
45/4.5 (1 Cyl), .456 inch Imp. I.D.	USA 5595532 and up AUS 8068065 and up BEL 9258281 and up CAN 7147238 and up	46- 70941A 3	N/A	47- 89981	47- 89981T 1	93224A 1
60 (6 hp)	1408611 - 1490054	N.L.A.	N/A	47- 22748	N/A	N.L.A.
60 (6 hp)	1490055 - 1582402	N.L.A.	N/A	47- 22748	N/A	N.L.A.
60 (6 hp)(12)	1582403 - 1916138	46- 46893A 6	N/A	47- 22748	N/A	N.L.A.
60 (6 hp)(12)	1916139 - 2193817	46- 46893A 6	N/A	47- 89981	N/A	N.L.A.
60 (6 hp)	2193818 - 2529894	46- 46893A 6	N/A	47- 89981	N/A	93224A 1
60J (6 hp)	2385673 - 2387383	N/A	N/A	47- 89981	N/A	N.L.A.
6	USA 0A197112 - 0T800749 BEL 9461526 and up	46- 42089A 5	N/A	47- 42038Q02	47- 42038T 3	46- 42089A 2

**Not all parts listed are available for the European, C.I.S., Africa and Middle East Markets.  
For more information, please contact your local Mercury, Mariner, MerCruiser or Quicksilver Office.**

# COOLING SYSTEM

Model	Serial # Range	Complete Pump Kit	Upper Kit	Impeller	Impeller Repair Kit	Upper Housing
75 (7.5 hp)	USA 2529895 - 4131609	46- 46893A 6	N/A	47- 89981	N/A	93224A 1
	AUS 8015315 - 8028839					
	BEL 9043194 - 9079488					
	CAN 7028598 - 7050207					
75 (7.5 hp)	USA 4131610 - 5226934	46- 70941A 3	N/A	47- 89981	47- 89981T 1	93224A 1
	AUS 8028840 - 8058019					
	BEL 9079489 - 9219255					
	CAN 7050206 - 7136037					
7.5 HP., .438 inch Imp. I.D.	USA 5206550 and up	N.L.A.	N/A	47- 89980	47- 89980T 1	93224A 1
	AUS 8057545 and up					
	BEL 9217756 and up					
	CAN 7125388 and up					
7.5 HP., .456 inch Imp. I.D.	USA 5206550 and up	46- 70941A 3	N/A	47- 89981	47- 89981T 1	93224A 1
	AUS 8057545 and up					
	BEL 9217756 and up					
	CAN 7125388 and up					
8	USA 0A197112 and up	46- 42089A 5	N/A	47- 42038Q02	47- 42038T 3	46- 42089A 2
	BEL 9461526 and up					
110 (9.8 hp)(13)	1865779 - 2196388	46- 46893A 6	N/A	47- 89981	N/A	N.L.A.
110 (9.8 hp)	2196389 - 3795657	46- 46893A 6	N/A	47- 89981	N/A	93224A 1
110 (9.8 hp)	USA 3795658 - 4126459	46- 46893A 6	N/A	47- 89981	N/A	93224A 1
	AUS 8015040 - 8028439					
	BEL 9041439 - 9078138					
	CAN 7027323 - 7049107					
110 (9.8 hp)	USA 4126460 - 5206549	46- 70941A 3	N/A	47- 89981	47- 89981T 1	93224A 1
	AUS 8028440 - 8057554					
	BEL 9078139 - 9217755					
	CAN 7049108 - 7125387					
9.8 HP., .438 inch Imp. I.D.	USA 5206550 and up	N.L.A.	N/A	47- 89980	47- 89980T 1	93224A 1
	AUS 8057545 and up					
	BEL 9217756 and up					
	CAN 7125388 and up					
9.8 HP., .456 inch Imp. I.D.	USA 5206550 and up	46- 70941A 3	N/A	47- 89981	47- 89981T 1	93224A 1
	AUS 8057545 and up					
	BEL 9217756 and up					
	CAN 7125388 and up					
9.9	USA 0A197112 and up	46- 42089A 5	N/A	47- 42038Q02	47- 42038T 3	46- 42089A 2
	BEL 9461526 and up					
XR10/ Sea Pro, 10 Magnum & Marathon	USA 0D038000 and up	46- 42089A 5	N/A	47- 42038Q02	47- 42038T 3	46- 42089A 2
	BEL 9596000 and up					
15	USA 0B292414 and up	46- 42089A 5	N/A	47- 42038Q02	47- 42038T 3	46- 42089A 2
	BEL 9542620 and up					
15 Sea Pro & Marathon	USA 0G044365 and up	46- 42089A 5	N/A	47- 42038Q02	47- 42038T 3	46- 42089A 2
	BEL 9927000 and up					
15XD/BigFoot	BEL 9927000 and up	N/A	46- 99157T 2	47- 85089 10	47- 85089T 4	46- 99157A02
18/18XD	USA 5837437 and up	N/A	46- 99157T 2	47- 85089 10	47- 85089T 4	46- 99157A02
	AUS 8071973 and up					
	BEL 9308306 and up					
200 (20 HP.)	1558310 - 1866495	N/A	N/A	N.L.A.	N/A	N.L.A.
200 (20 HP.)	1866496 - 2296266	N.L.A.	N/A	N.L.A.	N/A	N.L.A.
200 (20 HP.)(2)	2296267 - 2827676	N.L.A.	N/A	N.L.A.	N/A	N.L.A.
200 (20 HP.)(4)	2296267 - 2827676	N.L.A.	N/A	N.L.A.	N/A	N.L.A.
200 (20 HP.)	USA 2827677 - 6443972	46- 48744A 3	N/A	47- 89982	47- 89982T 1	N.L.A.
	AUS 8006265 and up					

# COOLING SYSTEM

Model	Serial # Range	Complete Pump Kit	Upper Kit	Impeller	Impeller Repair Kit	Upper Housing
20/20XD	BEL 9016254 - 9415100					
	CAN 7012358 - 7209532					
	USA 6443973 - 0T800749	N/A	46-99157T 2	47-85089 10	47-85089T 4	46-99157A02
25/25XD	BEL 9415101 and up					
	CAN 7209533 and up					
	USA 5705532 and up	N/A	46-99157T 2	47-85089 10	47-85089T 4	46-99157A02
25 Sea Pro/Marathon & Super 15	AUS 8073158 and up					
	BEL 9315316 and up					
	USA 0B238464 and up	N/A	46-99157T 2	47-85089 10	47-85089T 4	46-99157A02
25 (3 Cyl.)	BEL 9507381 and up					
	CAN 0A730007 and up					
	USA 0E268781 and up	N/A	46-99157T 2	47-85089 10	47-85089T 4	46-99157A02
300 (30 hp)	1271884 - 1448139	N/A	N/A	47-89983T	N/A	20270A 2
30 (2 Cyl.), 644cc	USA 0G053314 - 0T598999	N/A	N/A	47-85089 10	821354A 2	46-821351A 3
30 (2 Cyl.), 430cc, Lightning	USA 0G575500 and up	N/A	N/A	47-16154 1	853792T01	46-16156 2
30 Jet	USA 0C159200 - 0G589999	46-77177A 3	46-60366T 1	47-89983T	47-89983T 1	46-77822A 1
30 Jet	USA 0G590000 and up	N/A	N/A	47-85089 10	821354A 2	46-821351A 3
350 (35 HP)	1571114 - 1960826	N/A	N/A	47-89983T	N/A	20270A 2
350 (35 HP)(2)	1960827 - 2453068	N/A	N/A	47-89983T	N/A	46-60366Q 1
350 (35 HP)(4)	1960827 - 2453068	N/A	46-60366T 1	47-89983T	N/A	46-77822A 1
35 (2 Cyl.)	USA 6445653 and up	46-77177A 3	46-60366T 1	47-89983T	47-89983T 1	46-77822A 1
	BEL 9384476 and up					
	CAN 7209608 and up					
400 (40 hp)	1279685 - 1476509	N/A	N/A	47-89983T	N/A	20270A 2
400/402(40hp)	USA 2874704 - 4362214	N/A	46-60366T 1	47-89983T	47-89983T 1	46-77822A 1
	AUS 8002335 - 8036449					
	BEL 3339688 - 9108563					
	CAN 3340783 - 7070272					
402 (40 hp)	USA 4362215 - 4860102	N/A	46-60366T 1	47-89983T	47-89983T 1	46-77822A 1
	AUS 8036450 - 8052124					
	BEL 9108564 - 9184450					
	CAN 7070273 - 7112422					
402/40(2 Cyl), Through 1983	USA 4860103 and up	46-77177A 3	46-60366T 1	47-89983T	47-89983T 1	46-77822A 1
	AUS 8052125 and up					
	BEL 9184451 and up					
	CAN 7112423 and up					
40 (2 Cyl.), 1994 & Above, 644cc	USA 0G053314 and up	N/A	N/A	47-85089 10	821354A 2	46-821351A 3
40 (3 Cyl.)	USA 0G531301 and up	N/A	N/A	47-85089 10	821354A 2	46-821351A 3
	BEL 9973100 and up					
40 (4 Cyl.)	USA 0C159200 and up	46-77177A 3	46-60366T 1	47-89983T	47-89983T 1	46-77822A 1
	BEL 9570790 and up					
45 JET	USA 0D000750 and up	46-812966A11	N/A	47-19453T	47-19453T 2	14334A 3
45 (4 Cyl.)	USA 5531630 and up	46-77177A 3	46-60366T 1	47-89983T	47-89983T 1	46-77822A 1
	AUS 8063985 and up					
	BEL 9248006 and up					
	CAN 7143688 and up					
500 (50 hp)	1421113 - 1460498	N/A	N/A	47-89983T	N/A	20270A 2
500 (50 hp)	1477910 - 1521913	N/A	N/A	47-89983T	N/A	N.L.A.
500 (50 hp)	USA 1521914 - 2305100	N/A	N/A	47-89983T	N/A	46-60366Q 1
	CAN 1755549 - 2305100					
500 (50 hp)(2)	USA 2305101 - 2478119	N/A	N/A	47-89983T	N/A	46-60366Q 1
500 (50 hp)(4)	USA 2305101 - 2478119	N/A	46-60366T 1	47-89983T	47-89983T 1	46-77822A 1
500 (50 hp)(2)	CAN 2305101 - 2308830	N/A	N/A	47-89983T	N/A	46-60366Q 1

Not all parts listed are available for the European, C.I.S., Africa and Middle East Markets.  
 For more information, please contact your local Mercury, Mariner, MerCruiser or Quicksilver Office.

# COOLING SYSTEM

Model		Serial # Range	Complete Pump Kit	Upper Kit	Impeller	Impeller Repair Kit	Upper Housing
500 (50 hp)(4)	CAN	2305101 - 2308830	N/A	46- 60366T 1	47- 89983T	47- 89983T 1	46- 77822A 1
500 (50 hp)	USA	2514919 - 4357639	N/A	46- 60366T 1	47- 89983T	47- 89983T 1	46- 77822A 1
	AUS	2863739 - 8030089					
	BEL	9001581 - 9107213					
	CAN	2519919 - 7068997					
500/50 HP. (4 Cyl.)	USA	4357640 - 5531629	46- 73640A 2	46- 60366T 1	47- 89983T	47- 89983T 1	46- 77822A 1
	AUS	8030090 - 8063984					
	BEL	9107214 - 9248005					
	CAN	7068998 - 7143687					
50 HP. (4 Cyl)	USA	5531630 and up	46- 77177A 3	46- 60366T 1	47- 89983T	47- 89983T 1	46- 77822A 1
	AUS	8063985 and up					
	BEL	9248006 and up					
	CAN	7143688 and up					
50 HP. (3 Cyl)	USA	6428681 - 0D000749	46- 77177A 3	46- 60366T 1	47- 89983T	47- 89983T 1	46- 77822A 1
	BEL	9385911 - 9683054					
	CAN	7208333 and up					
50 HP. (3 Cyl)	USA	0D000750 - 0G589999	46-812966A11	N/A	47- 19453T	47- 19453T 2	14334A 3
	BEL	9683055 - 9973099					
50 HP. (3 Cyl)	USA	0G590000 and up	N/A	N/A	47- 85089 10	821354A 2	46-821351A 3
	BEL	9973100 and up					
55 HP. (3 Cyl)	USA	0D000750 and up	46-812966A11	N/A	47- 19453T	47- 19453T 2	14334A 3
	BEL	9741042 and up					
600 (60 hp)(6 Cyl.)		1303411 - 1542744	N/A	N/A	N.L.A.	N/A	N.L.A.
60 HP. (3 Cyl)	USA	6428681 - 0D000749	46- 77177A 3	46- 60366T 1	47- 89983T	47- 89983T 1	46- 77822A 1
	BEL	9385911 - 9683054					
	CAN	7208333 and up					
60 HP. (3 Cyl), Standard	USA	0D000750 and up	46-812966A11	N/A	47- 19453T	47- 19453T 2	14334A 3
	BEL	9683055 and up					
60 HP. (3 Cyl), BigFoot	USA	0D000750 and up	46- 43024A 7	N/A	47- 43026T 2	47- 43026K06	817275A 2
	BEL	9683055 and up					
650 (65 hp)(4 Cyl.)(2)		1542745 - 2803561	N/A	46- 96148A 8	47- 89984T 4	47- 89984T 5	46- 96148T 1
650 (65 hp)(4 Cyl.)(4)		1542745 - 2803561	N/A	46- 96148A 8	47- 89984T 4	47- 89984T 5	46- 96148T 1
650 (65 hp)(4 Cyl.)		2803562 - 2874263	N/A	46- 96148A 8	47- 89984T 4	47- 89984T 5	46- 96148T 1
650 (65 hp)(4 Cyl.)		2997439 - 3293183	N/A	46- 96148A 8	47- 89984T 4	47- 89984T 5	46- 96148T 1
65 HP (3 Cyl)	USA	3293184 - 4382056	N/A	46- 60366T 1	47- 89983T	N/A	46- 77822A 1
	AUS	8006640 - 8042349					
	BEL	9020074 - 9112988					
	CAN	7013633 - 7073472					
65 HP (3 Cyl)	USA	4382057 - 4571651	N/A	46- 60366T 1	47- 89983T	N/A	46- 77822A 1
	BEL	9112989 - 9135824					
	CAN	7073473 - 7087822					
65 JET	USA	0D283222 and up	46- 43024A 7	N/A	47- 43026T 2	47- 43026K06	817275A 2
	BEL	9793577 and up					
700 (70 hp)(6 Cyl.)		1266411 - 1413610	N/A	N/A	N.L.A.	N/A	N.L.A.
700 (70 hp)(6 Cyl.)		1413611 - 1436114	N/A	N/A	47- 89984T 4	N/A	N.L.A.
700 (70 hp)(6 Cyl.)		1482212 - 1503458	N/A	N/A	47- 89984T 4	N/A	N.L.A.
700 E-2 (70 hp)(6 Cyl.)		1503459 - 1503958	N/A	N/A	47- 89984T 4	N/A	N.L.A.
700 EL-2 (70 hp)(6 Cyl.)		1503459 - 1505110	N/A	N/A	47- 89984T 4	N/A	N.L.A.
700 E-2 (70 hp)(6 Cyl.)(11)		1503959 - 1566239	N/A	46- 96148A 8	47- 89984T 4	47- 89984T 5	46- 96148T 1
700 EL-2 (70 hp)(6 Cyl.)(11)		1505111 - 1566239	N/A	46- 96148A 8	47- 89984T 4	47- 89984T 5	46- 96148T 1

# COOLING SYSTEM

Model	Serial # Range	Complete Pump Kit	Upper Kit	Impeller	Impeller Repair Kit	Upper Housing
70 HP (3 Cyl)	USA 4571652 - 4977156	46- 73640A 2	46- 60366T 1	47- 89983T	N/A	46- 77822A 1
	AUS 8042350 - 8050199					
	BEL 9135825 - 9196960					
	CAN 7087823 - 7110997					
70 HP (3 Cyl)	USA 4977157 - 6428680	46- 77177A 3	46- 60366T 1	47- 89983T	47- 89983T 1	46- 77822A 1
	AUS 8050200 and up					
	BEL 9196961 - 9385910					
	CAN 7110998 - 7208332					
70 HP (3 Cyl)(6)	USA 0A996142 - 0C221999	46- 43024A 7	N/A	47- 43026T 2	N/A	817275A 2
	BEL 9483121 - 9589038					
70 HP (3 Cyl)(5)	USA 0A996142 - 0C221999	46- 43024A 7	N/A	47- 43026T 2	47- 43026K06	817275A 2
	BEL 9483121 - 9589038					
75 HP (4 Cyl)	USA 6432901 and up	46- 96148A 8	47- 89984T 4	47- 89984T 5	46- 96148T 1	
	BEL 9393856 and up					
	CAN 7208573 and up					
75 HP (3 Cyl)(6)	USA 0C222000 and up	46- 43024A 7	N/A	47- 43026T 2	N/A	817275A 2
	BEL 9589039 and up					
75 HP (3 Cyl)(5)	USA 0C222000 and up	46- 43024A 7	N/A	47- 43026T 2	47- 43026K06	817275A 2
	BEL 9589039 and up					
75 (3 Cyl) Optimax	USA 0T980000 and up	46- 43024A 7	N/A	47- 43026T 2	47- 43026K06	817275A 2
800 (80 hp)(6 Cyl.)	1335465 - 1398629	N/A	N/A	47- 89984T 4	N/A	N.L.A.
800 (80 hp)(6 Cyl.)	1398630 - 1566239	N/A	N/A	47- 89984T 4	N/A	N.L.A.
800 (80 hp)(4 Cyl.)	2559001 - 3144218	N/A	46- 96148A 8	47- 89984T 4	47- 89984T 5	46- 96148T 1
800 (80 hp)(4 Cyl.)	3144219 - 3493912	N/A	46- 96148A 8	47- 89984T 4	47- 89984T 5	46- 96148T 1
80 HP (4 Cyl)	USA 4831999 - 6432900	N/A	46- 96148A 8	47- 89984T 4	47- 89984T 5	46- 96148T 1
	AUS 8050200 and up					
	BEL 9177626 - 9393855					
	CAN 7110998 - 7208572					
80 HP (3 Cyl)(6)	USA 0A996142 - 0C221999	46- 43024A 7	N/A	47- 43026T 2	N/A	817275A 2
	BEL 9483121 - 9589038					
80 HP (3 Cyl)(5)	USA 0A996142 - 0C221999	46- 43024A 7	N/A	47- 43026T 2	47- 43026K06	817275A 2
	BEL 9483121 - 9589038					
80 JET	USA 0D283222 and up	46- 43024A 7	N/A	47- 43026T 2	47- 43026K06	817275A 2
	BEL 9793577 and up					
850 E, EL (85 hp)(6 Cyl.)	1460999 - 1567039	N/A	N/A	47- 89984T 4	N/A	N.L.A.
850 E-1, EL-1 (85 hp)(6 Cyl.)(11)	1566240 - 1766823	N/A	46- 96148A 8	47- 89984T 4	47- 89984T 5	46- 96148T 1
850, 850 XS (85 hp)(4 Cyl.)	USA 3493913 - 4590511	N/A	46- 96148A 8	47- 89984T 4	47- 89984T 5	46- 96148T 1
	BEL 9011604 - 9139349					
	CAN 7010108 - 7091097					
850 XS (85 hp)(4 Cyl.)	USA 3493913 - 4831998	N/A	46- 96148A 8	47- 89984T 4	47- 89984T 5	46- 96148T 1
	AUS 8043775 - 8050199					
	BEL 9011604 - 9177625					
	CAN 7010108 - 7110997					
850 XS (85 hp)(4 Cyl.)	USA 3493913 - 4831998	N/A	46- 96148A 8	47- 89984T 4	47- 89984T 5	46- 96148T 1
	AUS 8043775 - 8050199					
	BEL 9011604 - 9177625					
	CAN 7010108 - 7110997					
900 (90 hp)(6 Cyl.)(11)	1766824 - 1869775	N/A	46- 96148A 8	47- 89984T 4	47- 89984T 5	46- 96148T 1
90 HP (6 Cyl)	USA 4845301 and up	N/A	46- 96148A 8	47- 89984T 4	47- 89984T 5	46- 96148T 1
	AUS 8060545 and up					
	CAN 7111698 and up					
90 HP (3 Cyl)(6)	USA 0A996142 and up	46- 43024A 7	N/A	47- 43026T 2	N/A	817275A 2
	BEL 9483121 and up					

Not all parts listed are available for the European, C.I.S., Africa and Middle East Markets.  
 For more information, please contact your local Mercury, Mariner, MerCruiser or Quicksilver Office.

# COOLING SYSTEM

Model	Serial # Range	Complete Pump Kit	Upper Kit	Impeller	Impeller Repair Kit	Upper Housing
90 HP (3 Cyl)(5)	USA 0A996142 and up	46- 43024A 7	N/A	47- 43026T 2	47- 43026K06	817275A 2
	BEL 9483121 and up					
115 (3 Cyl) Optimax	USA 0T801000 and up	46- 43024A 7	N/A	47- 43026T 2	47- 43026K06	817275A 2
950 (95 hp)(6 Cyl)(11)	1869776 - 2318585	N/A	46- 96148A 8	47- 89984T 4	47- 89984T 5	46- 96148T 1
1000 (100 hp)(6 Cyl)	1464949 - 1503331	N/A		47- 89984T 4	N/A	N.L.A.
1000 (100 hp)(6 Cyl)(11)	1503332 - 2318585	N/A	46- 96148A 8	47- 89984T 4	47- 89984T 5	46- 96148T 1
1000 SS (E)(100 hp)(6 Cyl)(1)	USA 2318586 - 2413843	N/A	46- 96148A 8	47- 89984T 4	47- 89984T 5	46- 96148T 1
	CAN 2320991 - 2321200					
1000 SS (E)(100 hp)(6 Cyl)(3)	USA 2318586 - 2413843	N/A	46- 96148A 8	47- 89984T 4	47- 89984T 5	46- 96148T 1
	CAN 2320991 - 2321200					
1000 SS (E-1)(100 hp)(6 Cyl)(1)	USA 2484633 - 2836018	N/A	46- 96148A 8	47- 89984T 4	47- 89984T 5	46- 96148T 1
	CAN 2487363 - 2836018					
1000 SS (E-1)(100 hp)(6 Cyl)(3)	USA 2484633 - 2836018	N/A	46- 96148A 8	47- 89984T 4	47- 89984T 5	46- 96148T 1
	CAN 2487363 - 2836018					
1000 BP (100 hp)(6 Cyl.)	2399698 - 3253111	N/A	N/A	47- 89984T 4	N/A	N.L.A.
100 HP(4 Cyl)(6)	USA 0B209468 and up	46- 43024A 7	N/A	47- 43026T 2	N/A	817275A 2
	BEL 9523034 and up					
100 HP(4 Cyl)(5)	USA 0B209468 and up	46- 43024A 7	N/A	47- 43026T 2	47- 43026K06	817275A 2
	BEL 9523034 and up					
105 JET	USA 0D082000 and up	N/A	46- 96148A 8	47- 89984T 4	47- 89984T 5	46- 96148T 1
	BEL 9682500 and up					
1100 (110 hp)(6 Cyl)(1)	1870204 - 2314955	N/A	46- 96148A 8	47- 89984T 4	47- 89984T 5	46- 96148T 1
1100 (110 hp)(6 Cyl)(3)	1870204 - 2314955	N/A	46- 96148A 8	47- 89984T 4	47- 89984T 5	46- 96148T 1
1150 (115 hp)(6 Cyl.)	USA 2836019 - 4112634	N/A	46- 96148A 8	47- 89984T 4	47- 89984T 5	46- 96148T 1
	AUS 8008665 - 8027114					
	CAN 7010763 - 7047257					
1150 (115 hp)(6 Cyl.)	USA 4112635 - 4394236	N/A	46- 96148A 8	47- 89984T 4	47- 89984Q 5	46- 96148T 1
	AUS 8027115 - 8027439					
	CAN 7047258 - 7075522					
115 HP(6 Cyl)	USA 4394237 and up	N/A	46- 96148A 8	47- 89984T 4	47- 89984T 5	46- 96148T 1
	AUS 8027440 and up					
	CAN 7075523 and up					
115 HP(4 Cyl)(6)	USA 0C100000 and up	46- 43024A 7	N/A	47- 43026T 2	N/A	817275A 2
	BEL 9559771 and up					
115 HP(4 Cyl)(5)	USA 0C100000 and up	46- 43024A 7	N/A	47- 43026T 2	47- 43026K06	817275A 2
	BEL 9559771 and up					
115 (3 Cyl) Optimax	USA 0T801000 and up	46- 43024A 7	N/A	47- 43026T 2	47- 43026K06	817275A 2
115 Pro XS	USA 1B751825 and up	46- 43024A 7	N/A	47- 43026T 2	47- 43026K06	817275A 2
1250 (125 hp)(6 Cyl)(2)	2314956 - 2839368	N/A	46- 96148A 8	47- 89984T 4	47- 89984T 5	46- 96148T 1
1250 (125 hp)(6 Cyl)(4)	2314956 - 2839368	N/A	46- 96148A 8	47- 89984T 4	47- 89984T 5	46- 96148T 1
1250 BP (125 hp)(6 Cyl.)	2400058 - 3253111	N/A	N.L.A.	47- 89984T 4	N/A	N.L.A.
125 HP(4 Cyl)(6)	USA 0D283222 and up	46- 43024A 7	N/A	47- 43026T 2	N/A	817275A 2
	BEL 9793577 and up					
125 HP(4 Cyl)(5)	USA 0D283222 and up	46- 43024A 7	N/A	47- 43026T 2	47- 43026K06	817275A 2
	BEL 9793577 and up					
125 (3 cyl) Optimax	USA 1B736885 and up	46- 43024A 7	N/A	47- 43026T 2	47- 43026K06	817275A 2
1350(6 Cyl)	USA 2839369 - 3293233	N/A	46- 96148A 8	47- 89984T 4	47- 89984T 5	46- 96148T 1
1400 (140 hp)(6 Cyl.)	3293234 - 3502805	N/A	46- 96148A 8	47- 89984T 4	47- 89984T 5	46- 96148T 1
1400 (140 hp)(6 Cyl.)	USA 4865678 and up	N/A	46- 96148A 8	47- 89984T 4	47- 89984T 5	46- 96148T 1
	AUS 8052650 and up					
	CAN 7112773 and up					
1500(6 Cyl)	USA 3502806 - 4121434	N/A	46- 96148A 8	47- 89984T 4	47- 89984T 5	46- 96148T 1
	AUS 8005615 - 8028039					
	CAN 7010533 - 7048782					



# COOLING SYSTEM

Model	Serial # Range	Complete Pump Kit	Upper Kit	Impeller	Impeller Repair Kit	Upper Housing
1500(6 Cyl)(9)	USA 4121435 - 4865677	N/A	46-96148A 8	47-89984T 4	47-89984T 5	46-96148T 1
	AUS 8028040 - 8052649					
	CAN 7048783 - 7112772					
1500(6 Cyl)(10)	USA 4121435 - 4865677	N/A	46-96148A 8	47-89984T 4	47-89984T 5	46-96148T 1
	AUS 8028040 - 8052649					
	CAN 7048783 - 7112772					
1500 XS (6 Cyl)	USA 4868648 - 5327662	N/A	46-96148A 8	47-89984T 4	47-89984T 5	46-96148T 1
V-135 Carb	USA 0A904646 and up	N/A	46-96148A 8	47-89984T 4	47-89984T 5	46-96148T 1
V-135 DFI	USA 0G590000 and up	N/A	46-96148A 8	47-89984T 4	47-89984T 5	46-96148T 1
140 JET	USA 0D082000 and up	N/A	46-96148A 8	47-89984T 4	47-89984T 5	46-96148T 1
	BEL 9682500 and up					
V-150 Carb(8)	USA 4868998 - 0A904645	N/A	46-96148A 8	47-89984T 4	47-89984T 5	46-96148T 1
V-150 Carb(7)	USA 4868998 - 0A904645	N/A	46-96148A 8	47-89984T 4	47-89984T 5	46-96148T 1
V-150 Carb, EFI & DFI	USA 0A904646 and up	N/A	46-96148A 8	47-89984T 4	47-89984T 5	46-96148T 1
V-150XR2,4,6 - MAGNUM II,III(8)	USA 4868998 and up	N/A	46-96148A 8	47-89984T 4	47-89984T 5	46-96148T 1
V-150XR2,4,6 - MAGNUM II,III(7)	USA 4868998 and up	N/A	46-96148A 8	47-89984T 4	47-89984T 5	46-96148T 1
V-1750,V-175(8)	USA 4301235 - 6618750	N/A	46-96148A 8	47-89984T 4	47-89984T 5	46-96148T 1
	AUS 8064250 and up					
V-1750,V-175(7)	USA 4301235 - 6618750	N/A	46-96148A 8	47-89984T 4	47-89984T 5	46-96148T 1
	AUS 8064250 and up					
V-175 Carb, EFI & DFI	USA 6618751 and up	N/A	46-96148A 8	47-89984T 4	47-89984T 5	46-96148T 1
V-200(8)	USA 4839034 - 6625220	N/A	46-96148A 8	47-89984T 4	47-89984T 5	46-96148T 1
	AUS 8061595 - 8065672					
V-200(7)	USA 4839034 - 6625220	N/A	46-96148A 8	47-89984T 4	47-89984T 5	46-96148T 1
	AUS 8061595 - 8065672					
V-200 Carb & EFI (2.5L)	USA 6625221 and up	N/A	46-96148A 8	47-89984T 4	47-89984T 5	46-96148T 1
V-200 EFI (3.0L)	USA 0T750164 - 1B504988	817275A 5	N/A	47-43026T 2	47-43026K06	817275A 2
V-200 DFI (3.0L)	USA 0G386496 - 0G589999	817275A 6	N/A	47-43026T 2	47-43026K06	817275A 1
V-200 DFI (3.0L)	USA 0G590000 - 0T598999	817275A 5	N/A	47-43026T 2	47-43026K06	817275A 1
V-200 DFI (3.0L)	USA 0T599000 - 1B504988	817275A 5	N/A	47-43026T 2	47-43026K06	817275A 2
V-200 DFI (3.0L)	USA 1B504989 and up	817275A09	N/A	47-43026T 2	817275A08	817275A 2
V-220 LASER	USA 0B117316 and up	N/A	46-96148A 8	47-89984T 4	47-89984T 5	46-96148T 1
V-225 (2.4L)(8)	USA 5628028 and up	N/A	46-96148A 8	47-89984T 4	47-89984T 5	46-96148T 1
V-225 (2.4L)(7)	USA 5628028 and up	N/A	46-96148A 8	47-89984T 4	47-89984T 5	46-96148T 1
V-225 (3.0L) Carb & EFI	USA 0D280813 - 0G760299	N/A	N/A	47-43026T 2	47-43026K06	817275A 1
V-225 (3.0L) Carb & EFI	USA 0G760300 - 0T408999	817275A 5	N/A	47-43026T 2	47-43026K06	817275A 1
V-225 (3.0L) EFI	USA 0T409000 - 1B504988	817275A 5	N/A	47-43026T 2	47-43026K06	817275A 2
V-225 DFI	USA 0G590000 - 0T598999	817275A 5	N/A	47-43026T 2	47-43026K06	817275A 1
V-225 DFI	USA 0T599000 - 1B504988	817275A 5	N/A	47-43026T 2	47-43026K06	817275A 2
V-225 DFI	USA 1B504989 and up	817275A09	N/A	47-43026T 2	817275A08	817275A 2
V-225 Pro XS	USA 1B104549 - 1B752546	N/A	N/A	47-43026T 2	N/A	817275A 1
V-225 Pro XS	USA 1B752547 and up	817275A09	N/A	47-43026T 2	817275A08	817275A 1
V-250 (3.4L)	USA 0C101891 and up	N/A	N/A	47-85647	N.L.A.	N.L.A.
V-250 (3.0L) EFI	USA 0G129222 - 0T408999	N/A	N/A	47-43026T 2	47-43026K06	817275A 1
V-250 (3.0L) EFI	USA 0T409000 - 1B504988	817275A 5	N/A	47-43026T 2	47-43026K06	817275A 2
V-250 DFI	USA 1B528615 and up	817275A09	N/A	47-43026T 2	817275A08	817275A 2
V-250 Pro XS	USA 1B426561 - 1B752546	N/A	N/A	47-43026T 2	N/A	817275A 1
V-250 Pro XS	USA 1B752547 and up	817275A09	N/A	47-43026T 2	817275A08	817275A 2
V-275 (3.4L)	USA 0C101891 and up	N/A	N/A	47-85647	N.L.A.	N.L.A.
300/3.4L	USA 5611648 and up	N/A	N/A	47-85647	N.L.A.	N.L.A.
MARK 5	574128 - 786612	N/A	N/A	47-22748	N/A	N.L.A.
MARK 6, 6A	888005 and up	N/A	N/A	47-22748	N/A	N.L.A.
MARK 7	557618 - 825417	N/A	N/A	N.L.A.	N/A	N.L.A.
MARK 10, 10A	1057994 - 1122327	N/A	N/A	N.L.A.	N/A	N.L.A.

Not all parts listed are available for the European, C.I.S., Africa and Middle East Markets.  
 For more information, please contact your local Mercury, Mariner, MerCruiser or Quicksilver Office.

# COOLING SYSTEM

Model	Serial # Range	Complete Pump Kit	Upper Kit	Impeller	Impeller Repair Kit	Upper Housing
MARK 15A	1200114 - 1287384	N/A	N/A	N.L.A.	N/A	N.L.A.
MARK 15	595628 and up	N/A	N/A	N.L.A.	N/A	N.L.A.
MARK 20	700000 and up	N/A	N/A	N.L.A.	N/A	N.L.A.
MARK 20H	ALL and up	N/A	N/A	N.L.A.	N/A	N.L.A.
MARK 25	1036987 and up	N/A	N/A	N.L.A.	N/A	N.L.A.
MARK 28, 28A	1158546 - 1238089	N/A	N/A	N.L.A.	N/A	N.L.A.
MARK 30, 30E	ALL and up	N/A	N/A	N.L.A.	N/A	N.L.A.
MARK 30H	997920 and up	N/A	N/A	N.L.A.	N/A	N.L.A.
MARK 40	711400 and up	N/A	N/A	N.L.A.	N/A	N.L.A.
MARK 50	ALL and up	N/A	N/A	47- 89983T	N/A	20270A 2
MARK 55	831021 and up	N/A	N/A	47- 89983T	N/A	20270A 2
MARK 55A	1227131 and up	N/A	N/A	47- 89983T	N/A	20270A 2
MARK 55H	983920 and up	N/A	N/A	N.L.A.	N/A	N.L.A.
MARK 58 (E), MARK 58A (M&E)	1139538 and up	N/A	N/A	47- 89983T	N/A	20270A 2
MARK 75	1072997 and up	N/A	N/A	N.L.A.	N/A	N.L.A.
MARK 75A	1110600 and up	N/A	N/A	N.L.A.	N/A	N.L.A.
MARK 78	1143038 and up	N/A	N/A	N.L.A.	N/A	N.L.A.
MARK 78A	1194070 and up	N/A	N/A	N.L.A.	N/A	N.L.A.
KF3	358136 and up	N/A	N/A	N.L.A.	N/A	N.L.A.
KE4	214324 and up	N/A	N/A	N.L.A.	N/A	N.L.A.
KG4	ALL and up	N/A	N/A	N.L.A.	N/A	N.L.A.
KF5	338136 and up	N/A	N/A	N.L.A.	N/A	N.L.A.
KE7	ALL and up	N/A	N/A	N.L.A.	N/A	N.L.A.
KF7	ALL and up	N/A	N/A	N.L.A.	N/A	N.L.A.
KG7	ALL and up	N/A	N/A	N.L.A.	N/A	N.L.A.
KH7	500022 and up	N/A	N/A	N.L.A.	N/A	N.L.A.
KF9	377150 - 379008	N/A	N/A	N.L.A.	N/A	N.L.A.
KG9	405293 - 495761	N/A	N/A	N.L.A.	N/A	N.L.A.

- (1) Models with Aluminum upper pump housings
- (2) Models with Aluminum water pumps
- (3) Models with Plastic upper pump housings
- (4) Models with Plastic water pumps
- (5) Pump screws without insulators
- (6) Pump screws with insulators
- (7) Models with driveshaft retaining nut
- (8) Models without a driveshaft retaining nut
- (9) Models with flush hole
- (10) Models without flush hole
- (11) Models having plastic upper housing use a #48752 insert cup.
- (12) Units already having a complete pump replacement using 46-46893A 6 should use the 2193818-2529894 serial group for components
- (13) Units already having a complete pump replacement using 46-46893A 6 should use USA 3795658-4126549 grouping for components
- (14) Units which have already had a complete pump replacement with the 46-46893A 6 pump should use the chart below for components

## Early Mariner Impellers

Model	SN Code	Serial # Range	Impeller	Repair Kit
2A	646	ALL - ALL	47- 80395M	N.L.A.
2B (M)	6A1	008801 - 093604	47- 80395M	N.L.A.
2B (M)	6A1	131232 and up	47- 80395M	814453M
4A (M)	6E0	001011 and up	47- 96305M	N.L.A.
4A (ML)	6E0	300101 and up	47- 96305M	N.L.A.
5C (M)	6E3	102151 and up	47- 96305M	96325T
5C (ML)	6E3	400101 and up	47- 96305M	96325T

Model	SN Code	Serial # Range	Impeller	Repair Kit
6C (M)	6H8	000317 and up	47- 11590M	11656T
6C (ML)	6H8	300171 and up	47- 11590M	11656T
6D (M)	6H6	001302 and up	47- 11590M	11656T
6D (ML)	6H6	300406 and up	47- 11590M	11656T
8A (M)	655	00000 - 000300	47- 95611M	N.L.A.
8A (ML)	655	00000 - 300100	47- 95611M	N.L.A.
8B (M)	677	000101 and up	47- 95611M	84181T
8B (ML)	677	300101 and up	47- 95611M	84181T

Model	SN Code	Serial # Range	Impeller	Repair Kit
8C (M)	6G1	007990 and up	47- 11590M	11656T
8C (ML)	6G1	305951 and up	47- 11590M	11656T
8C (MUL)	6G1	700388 and up	47- 11590M	11656T
9.9C (M)	682	000551 and up	47- 84027T	46- 84277T
9.9C (ML)	682	300826 and up	47- 84027T	46- 84277T
9.9C (E)	682	250101 and up	47- 84027T	46- 84277T
9.9C (EL)	682	550141 and up	47- 84027T	46- 84277T
15A (M)	651	00000 - 000285	47- 95611M	N.L.A.
15A (ML)	651	00000 - 300100	47- 95611M	N.L.A.
15C (M)	684	000101 and up	47- 84027T	46- 84277T
15C (ML)	684	300101 and up	47- 84027T	46- 84277T
15C (E)	684	250101 and up	47- 84027T	46- 84277T
15C (EL)	684	550101 and up	47- 84027T	46- 84277T
20A (M)	653	ALL - ALL	47- 95533M	N.L.A.
20A (ML)	653	ALL - ALL	47- 95533M	N.L.A.
20C (M)	6A9	000101 - 005810	47- 84797M	97793T
20C (ML)	6A9	300101 - 303730	47- 84797M	97793T
20C (E)	6A9	250101 - 250360	47- 84797M	97793T
20C (EL)	6A9	550101 - 550385	47- 84797M	97793T
20C (M)	6A9	005811 - 010111	47- 84797M	42431M
20C (ML)	6A9	303731 - 306542	47- 84797M	42431M
20C (E)	6A9	250361 - 250819	47- 84797M	42431M
20C (EL)	6A9	550386 - 550693	47- 84797M	42431M
20C (M)	6A9	010112 and up	47- 84797M	95661T
20C (ML)	6A9	306543 and up	47- 84797M	N.L.A.
20C (E)	6A9	250820 and up	47- 84797M	N.L.A.
20C (EL)	6A9	550694 and up	47- 84797M	N.L.A.
25A (M)	648	ALL - ALL	47- 95533M	N.L.A.
25A (ML)	648	ALL - ALL	47- 95533M	N.L.A.
25A (E)	648	ALL - ALL	47- 95533M	N.L.A.
25A (EL)	648	ALL - ALL	47- 95533M	N.L.A.
25C (M)	695	00000 - 014870	47- 84797M	97793T
25C (ML)	695	00000 - 312185	47- 84797M	97793T
25C (E)	695	00000 - 252290	47- 84797M	97793T
25C (EL)	695	00000 - 553575	47- 84797M	97793T
25C (M)	695	014871 - 023895	47- 84797M	42431M
25C (ML)	695	312186 - 318173	47- 84797M	42431M
25C (E)	695	252291 - 253861	47- 84797M	42431M
25C (EL)	695	553576 - 555959	47- 84797M	42431M
25C (M)	695	023896 and up	47- 84797M	95661T
25C (ML)	695	318174 and up	47- 84797M	95661T
25C (E)	695	253862 and up	47- 84797M	95661T
25C (EL)	695	555960 and up	47- 84797M	95661T
28 (M)	664	ALL - ALL	47- 84797M	N.L.A.
28 (ML)	664	ALL - ALL	47- 84797M	N.L.A.
28 (E)	664	ALL - ALL	47- 84797M	N.L.A.
28 (EL)	664	ALL - ALL	47- 84797M	N.L.A.
30A (M)	689	000366 - 014805	47- 84797M	97793T
30A (ML)	689	301911 - 315315	47- 84797M	97793T
30A (E)	689	100251 - 103275	47- 84797M	97793T
30A (EL)	689	401216 - 407815	47- 84797M	97793T
30A (M)	689	014806 - 022058	47- 84797M	42431M
30A (ML)	689	315316 - 321376	47- 84797M	42431M
30A (E)	689	103276 - 105324	47- 84797M	42431M

Model	SN Code	Serial # Range	Impeller	Repair Kit
30A (EL)	689	407816 - 411946	47- 84797M	42431M
30A (M)	689	022059 and up	47- 84797M	95661T
30A (ML)	689	321377 and up	47- 84797M	95661T
30A (E)	689	105325 and up	47- 84797M	95661T
30A (EL)	689	411947 and up	47- 84797M	95661T
40A (M)	676	A00346 and up	47- 99971M	N.L.A.
40A (ML)	676	A41356 and up	47- 99971M	N.L.A.
40A (E)	676	A10121 and up	47- 99971M	N.L.A.
40A (EL)	676	A50631 and up	47- 99971M	N.L.A.
40B (M)	676	B000106 and up	47- 99971M	84363T
40B (ML)	676	B300101 and up	47- 99971M	84363T
40B (E)	676	B100461 and up	47- 99971M	84363T
40B (EL)	676	B400420 and up	47- 99971M	84363T
40C (M)	6E9	000106 and up	47- 99971M	84363T
40C (ML)	6E9	300126 and up	47- 99971M	84363T
40C (E)	6E9	100101 and up	47- 99971M	84363T
40C (EL)	6E9	400231 and up	47- 99971M	84363T
48 (M)	670	00000 - 02415	47- 81423M	N.L.A.
48 (ML)	670	00000 - 33125	47- 81423M	N.L.A.
48 (M)	670	02416 - 02640	47- 97108M	N.L.A.
48 (ML)	670	33126 - 34580	47- 97108M	N.L.A.
48 (M)	670	02641 and up	47- 97108M	N.L.A.
48 (ML)	670	34581 and up	47- 97108M	N.L.A.
W-48 (M)	670	002161 and up	47- 97108M	N.L.A.
W-48 (ML)	670	311996 and up	47- 97108M	N.L.A.
55 (M)	663	00000 - 02730	47- 81423M	N.L.A.
55 (ML)	663	00000 - 34925	47- 81423M	N.L.A.
55 (M)	663	02731 and up	47- 97108M	N.L.A.
55 (ML)	663	34926 and up	47- 97108M	N.L.A.
55 (E)	663	004041 and up	47- 97108M	84188T
55 (EL)	663	315379 and up	47- 97108M	84188T
W55 (ML)	663	578278 and up	47- 97108M	84188T
60 (E)	675	00101 and up	47- 97108M	84188T
60 (EL)	675	30101 and up	47- 97108M	84188T
60 (E)	6F0	000101 and up	47- 97108M	84188T
60 (EL)	6F0	300311 and up	47- 97108M	84188T

## OUTBOARD THERMOSTATS & TEMPERATURE SENDER

### WATER TEMPERATURE SENDER



**13536A13**

A two wire temperature sender for use on V-6 outboard product. Furnished standard on engine powerhead, the fiche card specific to the application should be used to verify correct use.

# COOLING SYSTEM

## WATER TEMPERATURE SENDER



**13536A14**

A four wire temperature sender for use on V-6 outboard product. Furnished standard on engine powerhead, the fiche card specific to the application should be used to verify correct use.

## WATER TEMPERATURE SENDER



**12415**

(1/8"-27 NPT threads)  
Fits outboard applications.

## TEMPERATURE SENDER KIT



**12415A 2**

Allows adding a temperature sender to outboards equipped with a factory built coastal flush. Includes a temperature sender, fittings, cable ties and instruction sheet. This kit provides for the use of a coastal flush and a temperature sender at the same time.

Fits Mercury/Mariner 75-125 hp. (1993 and newer) 2 cycle outboards. Primarily designed for adding to a Saltwater model which comes with the coastal flush as standard equipment.

## THERMOSTAT



**14586**

120 Degrees

## THERMOSTAT

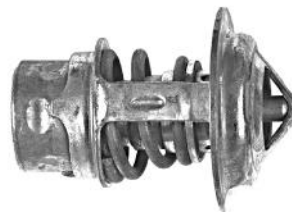

**75692**

143 Deg.

## THERMOSTAT - 110



**850055001**

## THERMOSTAT - 110

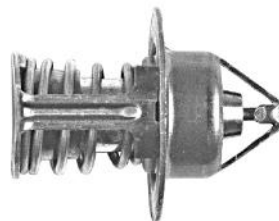

**F528068**

## THERMOSTAT

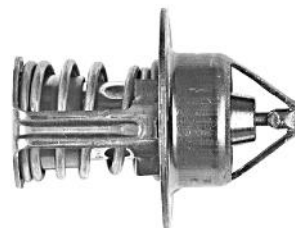

**F664068**

130 Deg.

THERMOSTAT

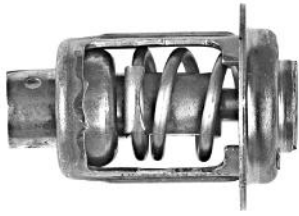

895338

130 Deg.

## REWIND STARTER

### STARTER ROPE AND RECOIL SPRING CHARTS

#### Mercury/Mariner Recoil Springs and Ropes

Model	Serial # Range	Manual Starter Recoil Spring	Manual Starter Replacement Rope
2.5 FourStroke	JPN 0R131842 and up	24-898101316	50-850057K01
3.5 FourStroke	JPN 0R131842 and up	24-898101316	50-850057K01
4 (40)(1 Cyl)	USA 2498136 - 4107219	N.L.A.	50-12066K10
	AUS 3306257 - 8026539		
	BEL 9000306 - 9072178		
	CAN 3305152 - 7045757		
4 (4, 40)(Gnat)	BEL 9075839 - 9256980	N.L.A.	50-90892A 2
	CAN 7085673 - 7146487	N.L.A.	50-90892A 2
4 (40)(2 Cyl)	USA 5589202 and up	N.L.A.	50-90892A 2
	AUS 8065265 and up		
	BEL 9256981 and up		
	CAN 7146488 and up		
4 (1 Cyl)	USA 5595532 - 0A809600	N.L.A.	50-12066K10
	AUS 8068065 and up		
	BEL 9258281 - 9477829		
	CAN 7143688 and up		
4 (1 Cyl)	USA 0A809601 - 0A834680	24-812645T	N.L.A.
	BEL 9477830 - 9542670		
4 (1 Cyl)	USA 0A834681 and up	24-812645T	50-850057K02
	BEL 9542671 and up		
4 FourStroke	JPN 0R000001 - 0R051739	24-812645T	50-850057K02
4 FourStroke	JPN 0R051740 and up	24-812645T10	50-850057K02
4.5 (4.5, 45)(1 Cyl)	USA 4107220 and up	N.L.A.	50-12066K10
	AUS 8026540 and up		
	BEL 9072179 and up		
	CAN 7045758 and up		
5 (1 Cyl)	USA 0A809601 - 0A834680	24-812645T	N.L.A.
	BEL 9477830 - 9542670		
5 (1 Cyl)	USA 0A834681 and up	24-812645T	50-850057K02
	BEL 9542671 and up		
5 FourStroke	JPN 0R000001 - 0R051739	24-812645T	50-850057K02
5 FourStroke	JPN 0R051740 and up	24-812645T10	50-850057K02
6 (60, 60J)	1408611 - 2387383	N.L.A.	50-12066K10
6	USA 0A197112 - 0D280999	N.L.A.(1)	50-850057K01
	BEL 9461526 - 9792199	N.L.A.(1)	50-850057K01
6	USA 0A197112 - 0D280999	24-86857T01(2)	50-850057K01
	BEL 9461526 - 9792199	24-86857T01(2)	50-850057K01
6	USA 0D281000 - 0T800749	24-86857T01	50-850057K01
	BEL 9792200 and up	24-86857T01	50-850057K01
6 FourStroke	JPN 0R000001 - 0R051739	24-812645T	50-850057K02
6 FourStroke	JPN 0R051740 and up	24-812645T10	50-850057K02
7.5 (7.5, 75)	USA 2529895 and up	N.L.A.	50-12066K10
	AUS 8015315 and up	N.L.A.	50-12066K10
	BEL 9043194 and up	N.L.A.	50-12066K10
	CAN 7028598 and up	N.L.A.	50-12066K10
8	USA 0A197112 - 0D280999	N.L.A.(1)	50-850057K01
	BEL 9461526 - 9792199	N.L.A.(1)	50-850057K01

Model	Serial # Range	Manual Starter Recoil Spring	Manual Starter Replacement Rope
8	USA 0A197112 - 0D280999	24-86857T01(2)	50-850057K01
	BEL 9461526 - 9792199	24-86857T01(2)	50-850057K01
8	USA 0D281000 and up	24-86857T01	50-850057K01
	BEL 9792200 and up	24-86857T01	50-850057K01
8 FourStroke(232 cc)	USA 0H000058 - 0H017349	N.L.A.	50-12066K10
8 FourStroke(232 cc)	USA 0G760300 and up	N.L.A.	50-12066K10
8 FourStroke(323cc)	BEL 0P086824 - 0P325499	24-852778	50-12066K10
8 FourStroke(209 cc)	JPN 0R042475 and up	24-804024T07	50-850057K02
	BEL 0P325500 and up	24-804024T07	50-850057K02
9.8 (110)	1470349 - 3795657	N.L.A.	50-12066K10
9.8 (9.8, 110)	USA 3795658 and up	N.L.A.	50-12066K10
	AUS 8015040 and up	N.L.A.	50-12066K10
	BEL 9041439 and up	N.L.A.	50-12066K10
	CAN 7027323 and up	N.L.A.	50-12066K10
9.9	USA 0A197112 - 0D280999	N.L.A.(1)	50-850057K01
	BEL 9461526 - 9792199	N.L.A.(1)	50-850057K01
9.9	USA 0A197112 - 0D280999	24-86857T01(2)	50-850057K01
	BEL 9461526 - 9792199	24-86857T01(2)	50-850057K01
9.9	USA 0D281000 and up	24-86857T01	50-850057K01
	BEL 9792200 and up	24-86857T01	50-850057K01
9.9 FourStroke(232cc)	USA 0H000058 - 0H016909	N.L.A.	50-12066K10
9.9 FourStroke(323cc)	USA 0G760300 - 0T979999	24-852778	50-12066K10
	BEL 0P075166 - 0P325499	24-852778	50-12066K10
9.9 FourStroke(209 cc)	JPN 0R042475 and up	24-804024T07	50-850057K02
	BEL 0P325500 and up	24-804024T07	50-850057K02
10 (100)	1290910 - 1455239	N.L.A.	50-12066K10
10 (Mark 10, 10A)	1057994 - 1122327	N.L.A.	50-12066K10
10 (XR10, Sea Pro 10)	USA 0D038000 - 0D280999	N.L.A.(1)	50-850057K01
	BEL 9596000 - 9792199	N.L.A.(1)	50-850057K01
10 (XR10, Sea Pro 10)	USA 0D038000 - 0D280999	24-86857T01(2)	50-850057K01
	BEL 9596000 - 9792199	24-86857T01(2)	50-850057K01
10 (XR10, Sea Pro 10)	USA 0D281000 and up	24-86857T01	50-850057K01
	BEL 9792200 and up	24-86857T01	50-850057K01
15 (Mark 15)	595628 and up	N.L.A.	50-12066K10
15 (Mark 15A)	1200114 - 1287384	N.L.A.	50-12066K10
15	1288910 - 1349697	N.L.A.	50-12066K10
15	USA 0B292414 - 0D280999	N.L.A.(1)	50-850057K01
	BEL 9542620 - 9792199	N.L.A.(1)	50-850057K01
15	USA 0B292414 - 0D280999	24-86857T01(2)	50-850057K01
	BEL 9542620 - 9792199	24-86857T01(2)	50-850057K01
15	USA 0D281000 and up	24-86857T01	50-850057K01
	BEL 9792200 and up	24-86857T01	50-850057K01
15 FourStroke, 323cc	USA 0G590000 - 1B727495	24-852778	50-12066K10
	BEL 9973100 and up	24-852778	50-12066K10
15 FourStroke, 351cc	JPN 0R235949 and up	24-804024008	50-850057K03
16 (Mark 20)	700000 and up	N.L.A.	50-12066K10
18 (18, 18XD)	USA 5837437 and up	24-86857T01	50-12066K10
	AUS 8071973 and up	24-86857T01	50-12066K10
	BEL 9308306 and up	24-86857T01	50-12066K10
	CAN 7173723 and up	24-86857T01	50-12066K10
20 (200)	1292910 - 3537530	N.L.A.	50-12066K10

Model	Serial # Range	Manual Starter Recoil Spring	Manual Starter Replacement Rope
20 (20, 200)	USA 3537531 - 6443972	N.L.A.	50- 12066K10
	AUS 8006265 and up	N.L.A.	50- 12066K10
	BEL 9016254 - 9415100	N.L.A.	50- 12066K10
	CAN 7012358 - 7209532	N.L.A.	50- 12066K10
20 (20, 20XD)	USA 6443973 - 0T800999	24- 86857T01	50- 12066K10
	BEL 9415101 and up	24- 86857T01	50- 12066K10
	CAN 7209533 and up	24- 86857T01	50- 12066K10
20 FourStroke	JPN 0R235168 and up	24-804024008	50-850057K03
22 (Mark 28)	1158546 - 1238089	N.L.A.	50- 12066K10
25 (250)	1467499 - 1499331	N.L.A.	50- 12066K10
25 (25, 25XD)	USA 5705532 and up	24- 86857T01	50- 12066K10
	AUS 8073158 and up	24- 86857T01	50- 12066K10
	BEL 9315316 and up	24- 86857T01	50- 12066K10
	CAN 7166928 and up	24- 86857T01	50- 12066K10
	USA 0E288000 and up	N.L.A.	50- 12066T03
25 (3 Cyl)(Lightning)	BEL 0E288781 - 0E287999	N.L.A.	50- 12066T03
	USA 0E288000 and up	N.L.A.	50- 12066T03
25 FourStroke(Carb)	USA 0G590000 - 1B344298	24- 86857T01	50- 12066K10
	BEL 9973100 - 0P388282	24- 86857T01	50- 12066K10
25 FourStroke(EFI)	JPN 0R106999 and up	24-804024008	50-850057K03
30 (300)	1271885 - 1356947	N.L.A.	50- 12066K10
30 (2 Cyl)(644cc)	USA 0G053314 and up	24- 86857T01	50- 12066K10
	BEL 9854537 and up	24- 86857T01	50- 12066K10
30 FourStroke	USA 0G760300 - 1B226999	24- 86857T01	50- 12066K10
	BEL 0P017000 - 0P400999	24- 86857T01	50- 12066K10
30 FourStroke(EFI)	JPN 0R106999 and up	24-804024008	50-850057Q03
35 (350)	1217222 - 1960826	N.L.A.	50- 12066K10
35 (350)	1960827 - 2874703	N.L.A.	50- 12066K10
35 (2 Cyl)	USA 6445653 and up	N.L.A.	50- 12066K10
	BEL 9384476 and up	N.L.A.	50- 12066K10
	CAN 7209608 and up	N.L.A.	50- 12066K10
40 (Mark 55)	831021 and up	N.L.A.	50- 12066K10
40 (400)	1279685 - 1476509	N.L.A.	50- 12066K10
40 (400)(2 Cyl)	2874704 - 3336257	N.L.A.	50- 12066K10
40 (40, 402) Through 1983	USA 3336258 and up	N.L.A.	50- 12066K10
	AUS 8002335 and up	N.L.A.	50- 12066K10
	BEL 3339688 and up	N.L.A.	50- 12066K10
	CAN 3340783 and up	N.L.A.	50- 12066K10
40 (644cc)(2 Cyl)	USA 0G053314 and up	24- 86857T01	50- 12066K10
	BEL 9854537 and up	24- 86857T01	50- 12066K10
40 (4 Cyl)	USA 0C159200 and up	N.L.A.	50- 12066K10
	BEL 9570790 and up	N.L.A.	50- 12066K10
40 (3 Cyl)	USA 0G531301 and up	24- 86857T01	50- 12066K10
	BEL 9973100 and up	24- 86857T01	50- 12066K10
40 FourStroke(3 cyl)	USA 0T409000 - 1B344306	24- 86857T01	50- 12066K10
	BEL 0P153500 and up		
	CHN 1C000001 and up		
40 FourStroke(4-Cyl)	USA 0G760300 - 0T408999	24- 86857T01	50- 12066K10
	BEL 0P153499 - 0P153499	24- 86857T01	50- 12066K10
45 (Mark 58)	1139538 and up	N.L.A.	50- 12066K10

Model	Serial # Range	Manual Starter Recoil Spring	Manual Starter Replacement Rope
45 (4 Cyl)	USA 5531630 and up	N.L.A.	50- 12066K10
	AUS 8063985 and up	N.L.A.	50- 12066K10
	BEL 9248006 and up	N.L.A.	50- 12066K10
	CAN 7143688 and up	N.L.A.	50- 12066K10
50 (500)	1421113 - 1755548	N.L.A.	50- 12066K10
50 (500)	USA 1770179 - 2116317	N.L.A.	50- 12066K10
	CAN 1755549 - 2097444	N.L.A.	50- 12066K10
50 (4 Cyl)(50, 500)	USA 2116318 and up	N.L.A.	50- 12066K10
	AUS 2863739 and up	N.L.A.	50- 12066K10
	BEL 9001581 and up	N.L.A.	50- 12066K10
	CAN 2097445 and up	N.L.A.	50- 12066K10
60 (Mark 75)	1072997 and up	N.L.A.	50- 12066K10
60 (600)(6 Cyl)	1303411 - 1542744	N.L.A.	50- 12066K10
65 (650)(4 Cyl)	1542745 - 1765043	N.L.A.	50- 12066K10
70 ( Mark 78)	1143038 and up	N.L.A.	50- 12066K10
70 (700)(6 Cyl)	1296411 - 1566239	N.L.A.	50- 12066K10

(1) Flywheel attached with stub shaft.

(2) Flywheel attached with nut.

### Early Mariner Recoil Springs & Ropes

Model	SN Code	Manual Starter Recoil Spring	Manual Starter Replacement Rope
	642	24- 80056M	50- 12066Q10
4A	6EO	24- 95484M	50- 12066Q10
5A	661	24- 80056M	50- 12066Q10
5C	6E3	24- 95484M	50- 12066Q10
6C	6H8	24- 95484M	50- 12066Q10
6D	6H6	24- 95484M	50- 12066Q10
8A	655	N.L.A.	50- 12066Q10
8B	677	N.L.A.	50- 12066Q10
8C	6G1	24- 95484M	50- 12066Q10
9.9C	682	N.L.A.	50- 12066Q10
15A	651	N.L.A.	50- 12066Q10
15C	684	N.L.A.	50- 12066Q10
20A	653	N.L.A.	50- 12066Q10
20C	6A9	24- 83588M	50- 12066Q10
25A	648	N.L.A.	50- 12066Q10
25C	695	24- 83588M	50- 12066Q10
28	664	N.L.A.	50- 12066Q10
30A	689	24- 83588M	50- 12066Q10
40	676	24- 83588M	50- 12066Q10
48	670	N.L.A.	50- 12066Q10
W-48	670	N.L.A.	50- 12066Q10
W-55	663	N.L.A.	50- 12066Q10

# POWERHEAD COMPONENTS

## POWERHEAD COMPONENTS

### HOSE CLAMP KIT

#### HOSE CLAMP KIT



**91-803146A04**

Various clamps and the crimping tool in a convenient plastic trayed container. Kit is originally furnished with 15 each of the 12.8mm, 14.0mm, 15.3mm, 16.2mm clamps and 5 each of the 25.6mm and 28.6mm diameter stainless steel clamps.

#### CRIMPING TOOL



**91-803146T**

#### HOSE CLAMP



**54-888441**

12.8 mm diameter stainless steel stepless ear clamp.

**54-850241**

14.0 mm diameter stainless steel stepless ear clamp.

**54-856880**

15.3 mm diameter stainless steel stepless ear clamp.

**54- 13791**

15.7 mm diameter stainless steel stepless ear clamp.

**54-855697**

16.2 mm diameter stainless steel stepless ear clamp.

#### HOSE CLAMP



**54-888988019**

22.6 mm diameter stainless steel stepless ear clamp.

Used on the new low permeation primer bulbs to provide a tight seal between the bulb and the valve.

#### HOSE CLAMP



**54-855228**

25.6 mm diameter stainless steel stepless ear clamp.

**54-850896**

28.6 mm diameter stainless steel stepless ear clamp.

### GASKET SETS - MERCURY/MARINER POWERHEAD

#### GASKET SET

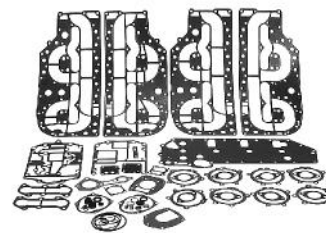

**27- 13461A99**

#### GASKET SET

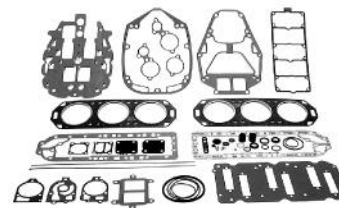

**27- 14697A87**



**GASKET SET**

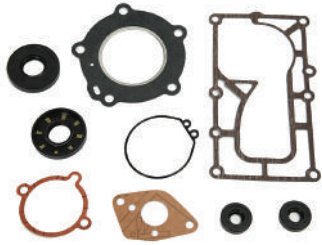

16115A03

**GASKET SET**



27-41499A88

**GASKET SET**

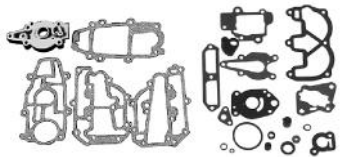

27-42364A92

**GASKET SET**

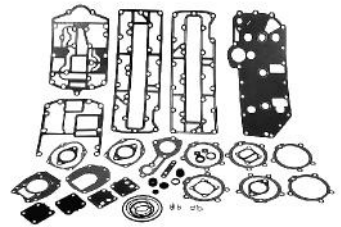

27-43004A99

**GASKET SET**

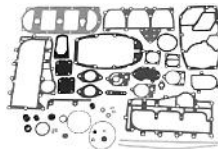

27-43779A87

**GASKET SET**

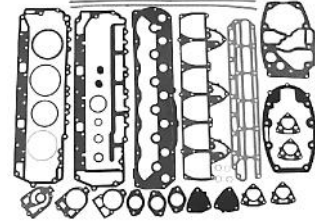

27-55284A 1

**GASKET SET**

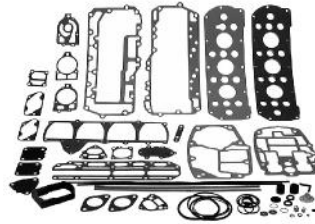

27-73645A87

**GASKET SET**



27-78028A78

**GASKET SET**

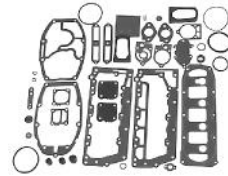

27-85491A90

**GASKET SET**

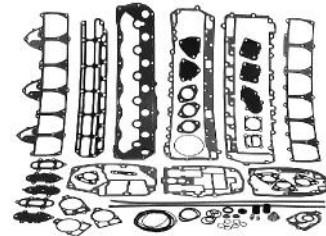

27-85653A87

# POWERHEAD COMPONENTS

## GASKET SET

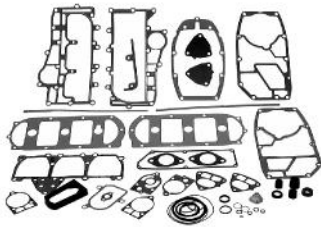

27- 88449A32

## GASKET SET

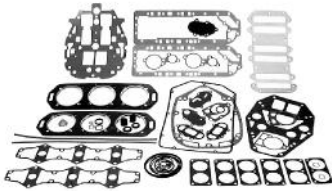

27- 89221A80

## GASKET SET

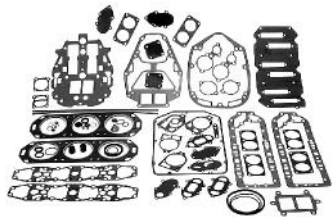

27- 89221A88

## GASKET SET

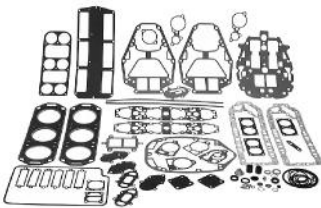

27- 90484A88

## GASKET SET

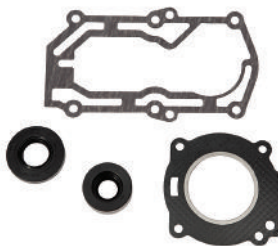

27-898101928

## GASKET SET

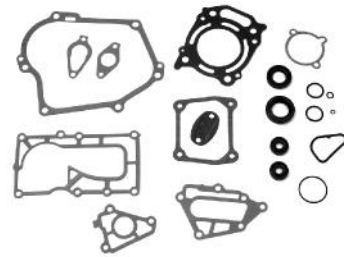

27-803508A05

Fits the 4/5/6 hp. FourStroke outboards s/n 0R057260-0R067089.

## GASKET SET

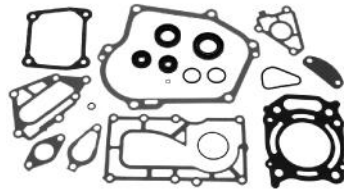

27-803508T06

Fits the 4/5/6 hp. FourStroke outboard, serial number 0R067090 & above.

## GASKET SET

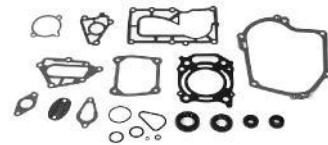

27-803508A99

Fits the 4/5/6 hp. FourStroke outboards s/n 0R057259 & prior.

## GASKET SET

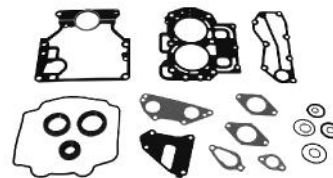

27-803663A08

Fits the 20 hp. FourStroke outboard beginning with serial number 0R235168.

**GASKET SET**

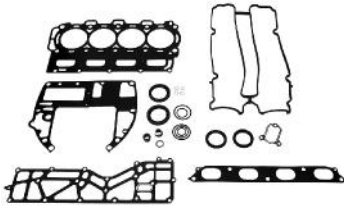

27-804345A02

**GASKET SET**

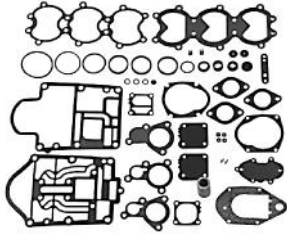

27-812867A97

**GASKET SET**

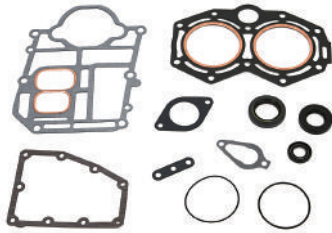

27-8M0084273

**GASKET SET**

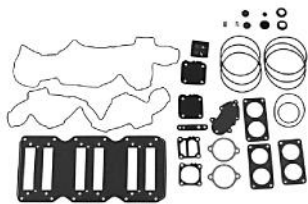

27-814195A93

**GASKET SET**

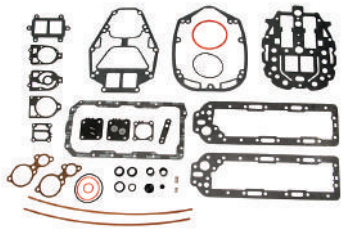

27-815076A04

**GASKET SET**



27-815791A92

Complete powerhead gasket set. Cylinder head gaskets are not included and need to be purchased separately.

**GASKET SET**

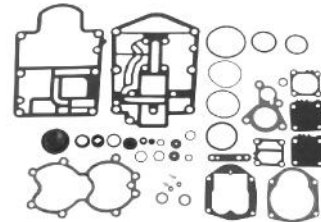

27-822420A94

**GASKET SET**

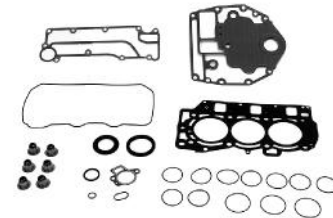

27-825231A02

**GASKET SET**

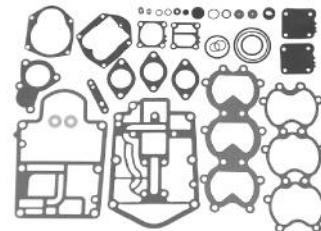

27-828553A97

# POWERHEAD COMPONENTS

## GASKET SET

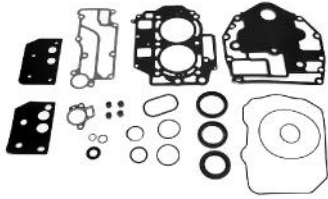

27-830270A02

## GASKET SET

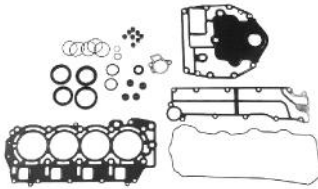

27-832013A96

## GASKET SET



27-832934A98

## GASKET SET

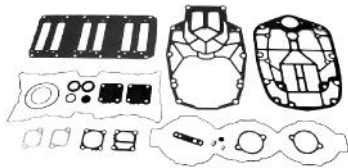

27-832934A00

## GASKET SET

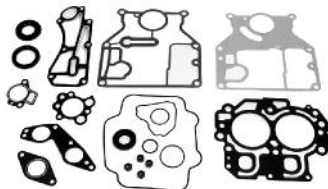

27-835427A00

## GASKET SET

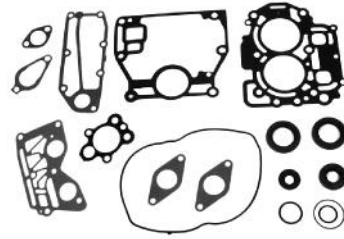

27-835427A04

Fits the 8/9.9 hp. FourStroke outboard, beginning with Model Year 2005.

## GASKET SET

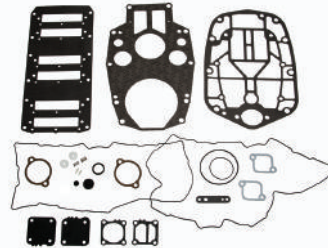

27-841220A03

Powerhead gasket set.

Fits the 250 ProXS outboard (1B246561 and above), 250XS outboard (1T651945 abd above), and the 300XS outboard (1E001867 and above).

## GASKET SET

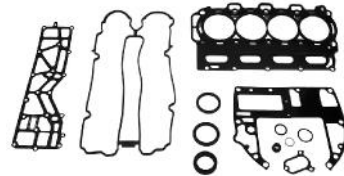

27-858732A03

## GASKET SET

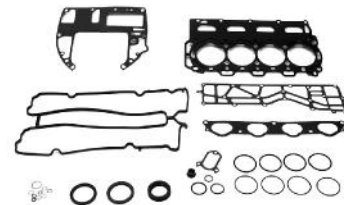

27-858732T02



**GASKET SET**

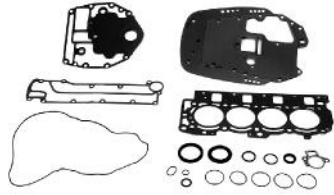

**27-859352A01**

**GASKET SET**

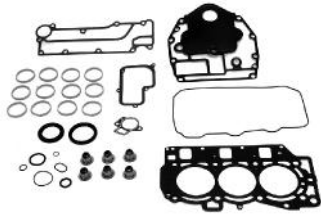

**27-859352A02**

**GASKET SET**

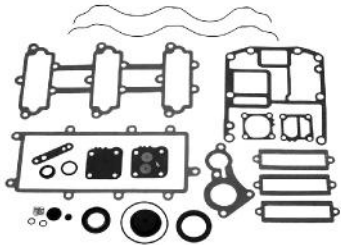

**27-879855A04**

Fits the Mercury/Mariner 75/90/115 hp. (3 cylinder) 1.5L OptiMax outboard.

**GASKET SET**

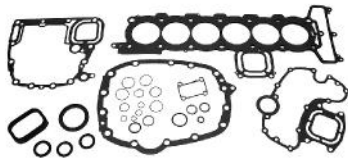

**27-880552A07**

The head gasket is included in this kit.  
Fits the 200-300 hp. FourStroke (6 cylinder) Verado outboard.

**GASKET SET**

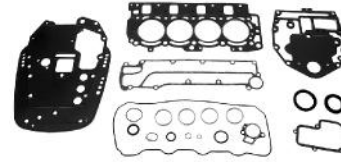

**27-883599A02**

Fits the 40/50/60 EFI FourStroke outboards, beginning with serial number 0T40900 & above.

**GASKET SET**

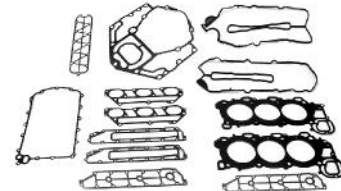

**27-887810A03**

**GASKET SET**

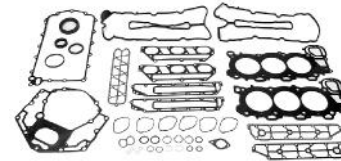

**27-887810A04**

**GASKET SET**

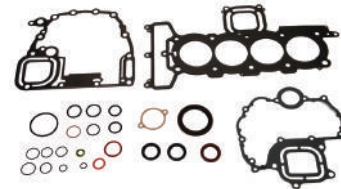

**27-896142A07**

Head gasket is included in this kit.  
Fits the FourStroke 4-cylinder Verado outboard.

# POWERHEAD COMPONENTS

## GASKET SET



**27-897534A07**

Fits the 75/90/115 hp. EFI FourStroke outboard, serial number 1B366823-2B094995.

## GASKET SET



**27-8M0079064**

## GASKET SET

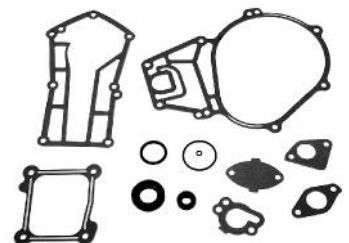

**27-898103A67**

Fits the 2.5/3.5 hp. FourStroke outboard, serial number 0R131842 & above.

## GASKET SET

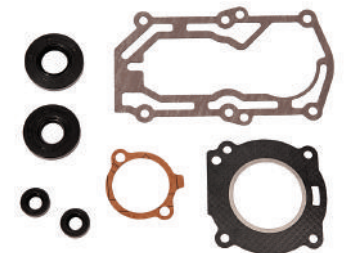

**27-8M0046714**

Complete gasket set. Cylinder head gaskets are not included and need to be purchased separately.

## GASKET SET

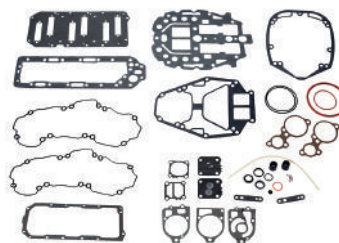

**27-8M0046715**

## GASKET SET

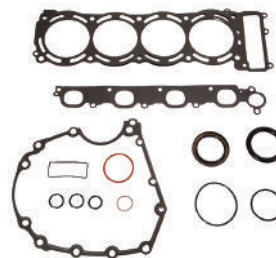

**27-8M0057763**

Contains the strainer seal, "o" rings, exhaust gasket, adapter plate gasket, cylinder head gasket and top main bearing seal.

Fits the F150 Hp. EFI FourStroke outboard, serial number 1B905505 and above.

## GASKET SETS - EARLY MARINER

### HEAD SEALING O-RINGS

#### HEAD O-RING

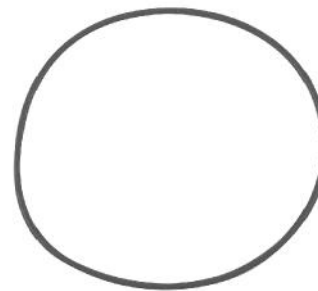

**25-818573**

#### HEAD O-RING

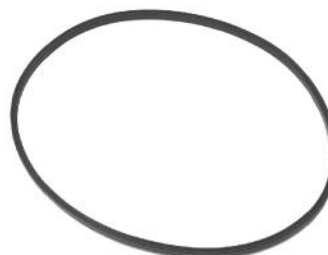

**859772 1**

HEAD O-RING

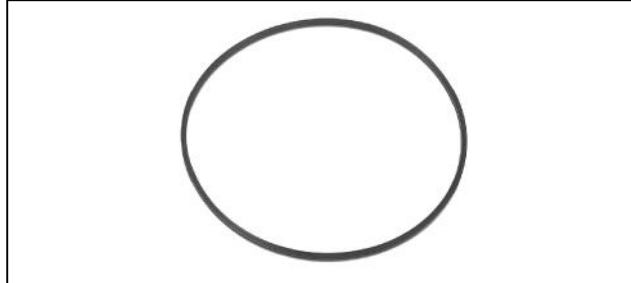

878453

HEAD SEAL

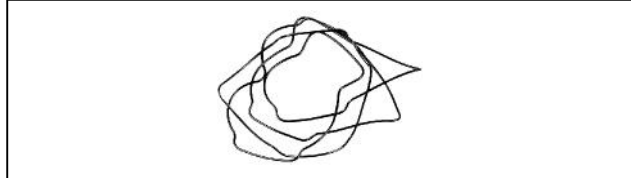

818574

HEAD SEAL

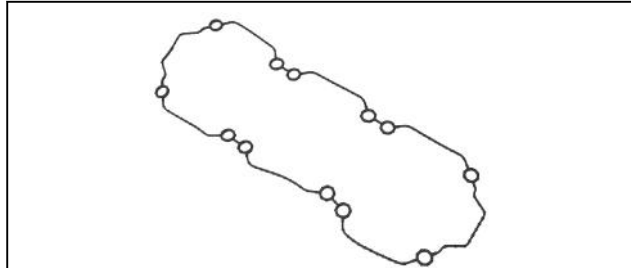

858452 1

HEAD GASKETS

HEAD GASKET

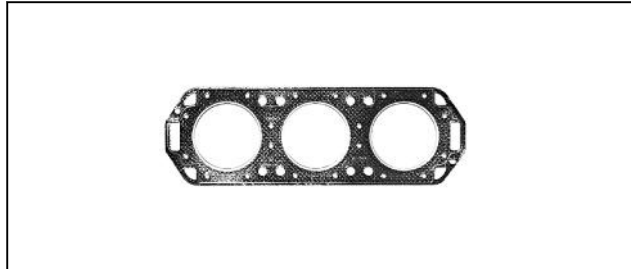

27- 18785T

HEAD GASKET

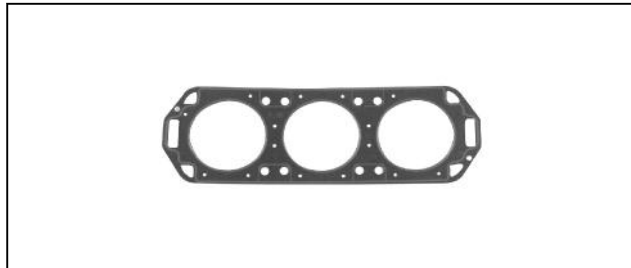

27- 18786T

HEAD GASKET



27- 41244T02

HEAD GASKET



27- 41247T01

HEAD GASKET

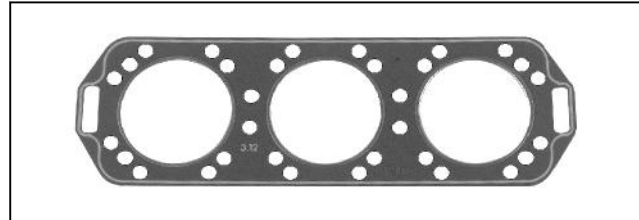

27- 79583 1

HEAD GASKET



27- 96281T01

HEAD GASKET



27-812939T25

Fits the 20 hp. FourStroke outboard beginning with serial number 0R235168.

**POWERHEAD COMPONENTS**

**HEAD GASKET**



27-803508 2

**HEAD GASKET**



27-8M0052705

**GASKET**



27-804115 1

**HEAD GASKET**

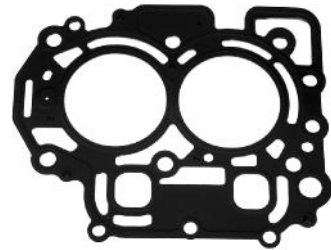

27-850836001

Fits the 8/9.9 hp. FourStroke outboard, beginning with Model Year 2005.

**HEAD GASKET**



27-822844T05

**HEAD GASKET**

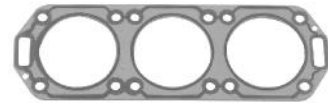

27-852520 3

Quicksilver Branded

**HEAD GASKET**

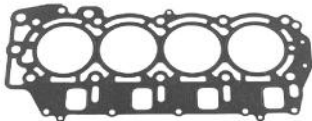

27-825032

**HEAD GASKET**



27-8M0045278

**HEAD GASKET**

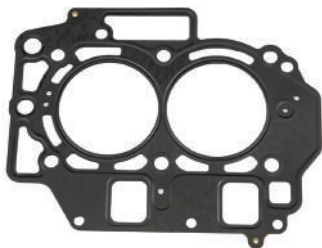

27-8M0049885



**HEAD GASKET**



**27-887848002**

Starboard side cylinder head gasket.

**HEAD GASKET**



**27-887848003**

Port side cylinder head gasket.

**HEAD GASKET**



**27-8M0033476**

**HEAD GASKET**



**27-8M0024565**

**HEAD GASKET**

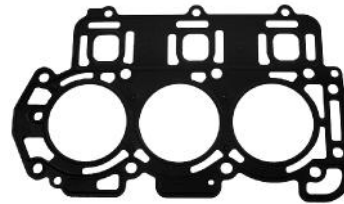

**27-898101T41**

**HEAD GASKET**

Image not Available.

**27-8M0090776**

Cylinder head gasket.  
Fits the F75-115 (2.1L) FourStroke outboard (s/n USA 2B094996 and above).

**GASKET SET APPLICATION CHARTS - POWERHEAD**

**Mercury/Mariner Powerhead Gasket Sets**

Model	Serial # Range	Gasket Set	Head O-Rings	Head Gaskets	Head Seals
2.5 FourStroke	JPN 0R131842 and up	27-898103A67	N/A	N/A	N/A
3.5 FourStroke	JPN 0R131842 and up	27-898103A67	N/A	N/A	N/A
2.5	0A855097 - 0G710612	27-898101928	N/A	N/A	N/A
3	0A855097 and up	27-898101928	N/A	N/A	N/A
3.3 NON-SHIFT	0D901217 and up	27-898101928	N/A	N/A	N/A
3.3 SHIFT	0D901217 and up	27-815076A04	N/A	N/A	N/A
3.5 (water cooled)	USA 6202173 and up	N.L.A.	N/A	N/A	N/A
3.6 (water cooled)	USA 5404657 and up	N.L.A.	N/A	N/A	N/A
3.6 (water cooled)	BEL 9252831 and up	N.L.A.	N/A	N/A	N/A
3.6 (water cooled)	CAN 7145388 and up	N.L.A.	N/A	N/A	N/A
3.9 (39)	USA 1655013 - 2095745	N.L.A.	N/A	N/A	N/A
3.9 (39)	USA 2098037 - 2498135	N.L.A.	N/A	N/A	N/A
4 (1 cyl.)	USA 2498136 - 0A809600	N.L.A.	N/A	N/A	N/A

Not all parts listed are available for the European, C.I.S., Africa and Middle East Markets.  
For more information, please contact your local Mercury, Mariner, MerCruiser or Quicksilver Office.

# POWERHEAD COMPONENTS

Model		Serial # Range	Gasket Set	Head O-Rings	Head Gaskets	Head Seals
4 (1 cyl.)	AUS	3306257 and up	N.L.A.	N/A	N/A	N/A
4 (1 cyl.)	BEL	9000306 - 9477829	N.L.A.	N/A	N/A	N/A
4 (1 cyl.)	CAN	3305152 and up	N.L.A.	N/A	N/A	N/A
4 (1 cyl.)	USA	0A809601 - 0A855096	N.L.A.	N/A	N/A	N/A
4 (1 cyl.)	BEL	9477830 - 9589153	N.L.A.	N/A	N/A	N/A
4 (1 cyl.)	USA	0A855097 - 0G710612	16115A03	N/A	N/A	N/A
4 (1 cyl.)	BEL	9589154 - 0P016999	16115A03	N/A	N/A	N/A
4 (2 cyl.)		ALL and up	N.L.A.	N/A	N/A	N/A
4 FourStroke	JPN	0R000001 - 0R057259	27-803508A99	N/A	27-803508	N/A
4 FourStroke	JPN	0R057260 - 0R067089	27-803508A05	N/A	27-803508	N/A
4 FourStroke	JPN	0R067090 and up	27-803508T06	N/A	27-803508 2	N/A
4.5 (1 cyl.)	USA	2498136 - 0A809600	N.L.A.	N/A	N/A	N/A
4.5 (1 cyl.)	AUS	3306257 and up	N.L.A.	N/A	N/A	N/A
4.5 (1 cyl.)	BEL	9000306 - 9477829	N.L.A.	N/A	N/A	N/A
4.5 (1 cyl.)	CAN	3305152 and up	N.L.A.	N/A	N/A	N/A
5 (1 cyl.)	USA	0A809601 - 0A855096	N.L.A.	N/A	N/A	N/A
5 (1 cyl.)	BEL	9477830 - 9589153	N.L.A.	N/A	N/A	N/A
5 (1 cyl.)	USA	0A855097 - 0G710612	16115A03	N/A	N/A	N/A
5 (1 cyl.)	BEL	9589154 - 0P016999	16115A03	N/A	N/A	N/A
5 FourStroke	JPN	0R000001 - 0R057259	27-803508A99	N/A	27-803508	N/A
5 FourStroke	JPN	0R057260 - 0R067089	27-803508A05	N/A	27-803508	N/A
5 FourStroke	JPN	0R067090 and up	27-803508T06	N/A	27-803508 2	N/A
6 (60, 60J)	USA	1408611 - 2387383	N.L.A.	N/A	N/A	N/A
6 (60, 60J)	CAN	1958792 - 2387383	N.L.A.	N/A	N/A	N/A
6	USA	0A197112 - 0T800749	27-42364A92	N/A	N/A	N/A
6	BEL	9461526 and up	27-42364A92	N/A	N/A	N/A
6 FourStroke	JPN	0R000001 - 0R057259	27-803508A99	N/A	27-803508	N/A
6 FourStroke	JPN	0R057260 - 0R067089	27-803508A05	N/A	27-803508	N/A
6 FourStroke	JPN	0R067090 and up	27-803508T06	N/A	27-803508 2	N/A
7.5 (7.5, 75)	USA	2529895 and up	N.L.A.	N/A	N/A	N/A
7.5 (7.5, 75)	AUS	8015315 and up	N.L.A.	N/A	N/A	N/A
7.5 (7.5, 75)	BEL	9043194 and up	N.L.A.	N/A	N/A	N/A
7.5 (7.5, 75)	CAN	7028598 and up	N.L.A.	N/A	N/A	N/A
8	USA	0A197112 and up	27-42364A92	N/A	N/A	N/A
8	BEL	9461526 and up	27-42364A92	N/A	N/A	N/A
8 FourStroke(232 cc)	USA	0H000058 - 0H017349	N.L.A.	N/A	N.L.A.	N/A
8 FourStroke(232 cc)	USA	0G760300 - 0T178499	N.L.A.	N/A	N.L.A.	N/A
8 FourStroke(323 CC)	BEL	0P086824 - 0P325499	27-835427A00	N/A	27-8M0052705	N/A
8 FourStroke	JPN	0R042475 and up	27-835427A04	N/A	27-850836001	N/A
8 FourStroke	BEL	0P325500 and up	27-835427A04	N/A	27-850836001	N/A
9.8 (9.8, 110)	USA	1470349 and up	N.L.A.	N/A	N/A	N/A
9.8 (9.8, 110)	AUS	8015040 and up	N.L.A.	N/A	N/A	N/A
9.8 (9.8, 110)	BEL	9041439 and up	N.L.A.	N/A	N/A	N/A
9.8 (9.8, 110)	CAN	7027323 and up	N.L.A.	N/A	N/A	N/A
9.9	USA	0A197112 and up	27-42364A92	N/A	N/A	N/A
9.9	BEL	9461526 and up	27-42364A92	N/A	N/A	N/A
9.9 FourStroke(232 CC)	USA	0H000058 - 0H017349	N.L.A.	N/A	N.L.A.	N/A
9.9 FourStroke(323 CC)	USA	0G760300 - 0T979999	27-835427A00	N/A	27-8M0052705	N/A
9.9 FourStroke(323 CC)	BEL	0P075166 - 0P325499	27-835427A00	N/A	27-8M0052705	N/A
9.9 FourStroke	JPN	0R042475 and up	27-835427A04	N/A	27-850836001	N/A
9.9 FourStroke	BEL	0P325500 and up	27-835427A04	N/A	27-850836001	N/A
10 (100)		1290910 - 1499331	N.L.A.	N/A	N/A	N/A
10 (XR10/SEA PRO 10)	USA	0D038000 and up	27-42364A92	N/A	N/A	N/A
10 (XR10/SEA PRO 10)	BEL	9596000 and up	27-42364A92	N/A	N/A	N/A

Model	Serial # Range	Gasket Set	Head O-Rings	Head Gaskets	Head Seals
10 Magnum/Marathon	USA 0D038000 and up	27- 42364A92	N/A	N/A	N/A
10 Magnum/Marathon	BEL 9596000 and up	27- 42364A92	N/A	N/A	N/A
15 (150)	1290910 - 1499331	N.L.A.	N/A	N/A	N/A
15 (15, 15 Sea Pro/Marathon)	USA 0B292414 and up	27- 42364A92	N/A	N/A	N/A
15 (15, 15 Sea Pro/Marathon)	BEL 9542620 and up	27- 42364A92	N/A	N/A	N/A
15 XD Sea Pro/Marathon.	BEL 9927000 and up	27- 41499A88	N/A	N/A	N/A
15 (Super 15)	USA 0B238464 and up	27- 41499A88	N/A	N/A	N/A
15 (Super 15)	BEL 9507381 and up	27- 41499A88	N/A	N/A	N/A
15 (Super 15)	CAN 0A730007 and up	27- 41499A88	N/A	N/A	N/A
15 FourStroke, 323cc	USA 0G760300 and up	27-835427A00	N/A	27-8M0052705	N/A
15 FourStroke, 323cc	BEL 0P075166 and up	27-835427A00	N/A	27-8M0052705	N/A
15 FourStroke, 351cc	JPN 0R235949 and up	27-803663A08	N/A	27-812939T25	N/A
18	USA 5837437 - 6416712	N.L.A.	N/A	N/A	N/A
18	AUS 8071973 and up	N.L.A.	N/A	N/A	N/A
18	BEL 9308306 - 9378115	N.L.A.	N/A	N/A	N/A
18	CAN 7173723 - 7207857	N.L.A.	N/A	N/A	N/A
18 (18XD)	USA 6416713 - 6443972	27- 41499A88	N/A	N/A	N/A
18 (18XD)	BEL 9378116 - 9415100	27- 41499A88	N/A	N/A	N/A
18 (18XD)	CAN 7207858 - 7209532	27- 41499A88	N/A	N/A	N/A
20 (200)	1290910 - 3537530	N.L.A.	N/A	N/A	N/A
20 (20, 20XD, 200)	USA 3537531 - 6443972	N.L.A.	N/A	N/A	N/A
20 (20, 20XD, 200)	AUS 8006265 and up	N.L.A.	N/A	N/A	N/A
20 (20, 20XD, 200)	BEL 9016254 - 9415100	N.L.A.	N/A	N/A	N/A
20 (20, 20XD, 200)	CAN 7012358 - 7209532	N.L.A.	N/A	N/A	N/A
20 (20, 20XD, 200)	USA 6443973 - 0T800999	27- 41499A88	N/A	N/A	N/A
20 (20, 20XD, 200)	BEL 9415101 and up	27- 41499A88	N/A	N/A	N/A
20 (20, 20XD, 200)	CAN 7209533 and up	27- 41499A88	N/A	N/A	N/A
20 JET	USA 0G044027 and up	27- 41499A88	N/A	N/A	N/A
20 JET	BEL 9807909 and up	27- 41499A88	N/A	N/A	N/A
20 FourStroke	JPN 0R235168 and up	27-803663A08	N/A	27-812939T25	N/A
25 (250)	1290910 - 1499331	N.L.A.	N/A	N/A	N/A
25	USA 5705532 - 6416712	N.L.A.	N/A	N/A	N/A
25	AUS 8073158 and up	N.L.A.	N/A	N/A	N/A
25	BEL 9315316 - 9378115	N.L.A.	N/A	N/A	N/A
25 (25, 25XD)	USA 6416713 - 0T979999	27- 41499A88	N/A	N/A	N/A
25 (25, 25XD)	BEL 9378116 - 0P325499	27- 41499A88	N/A	N/A	N/A
25 (25, 25XD)	CAN 7207858 and up	27- 41499A88	N/A	N/A	N/A
25 LIGHTNING(3 cyl)	USA 0E268781 and up	N.L.A.	N/A	N/A	N/A
25 FourStroke (Carb)	USA 0G590000 - 1B344298	27-830270A02	N/A	27-8M0049885	N/A
25 FourStroke (EFI)	JPN 0R106999 and up	27-8M0079064	N/A	27-898101T41	N/A
25 FourStroke JET	JPN 0R165086 and up	27-8M0079064	N/A	27-898101T41	N/A
30 (300)	127884 and up	N.L.A.	N/A	N/A	N/A
30 (2 cyl)(644cc)	USA 0G053314 and up	27-822420A94	N/A	N/A	N/A
30 LIGHTNING(430cc)	USA 0G575500 and up	27-8M0084273	N/A	N/A	N/A
30 (4-Stroke)(3 cyl) Carb	USA 0G760300 - 0T408999	27-825231A99	N/A	27-834777	N/A
30 (4-Stroke)(3 cyl) Carb	USA 0T409000 - 1B226999	27-825231A02	N/A	27-834777	N/A
30 (4-Stroke)(3 cyl) Carb	BEL 0P153500 - 0P400999	27-825231A02	N/A	27-834777	N/A
30 (4-Stroke)(3 cyl) EFI	USA 0T409000 - 1B226999	27-859352A02	N/A	27-834777	N/A
30 FourStroke (EFI)	JPN 0R106999 and up	27-8M0079064	N/A	27-898101T41	N/A
30 JET (40 hp)(4 cyl)	USA 0C159200 and up	27- 85491A90	N/A	N/A	N/A
30 JET (40 hp)(4 cyl)	BEL 9570790 and up	27- 85491A90	N/A	N/A	N/A
30 JET (50 hp)(3 cyl)	USA 0G590000 and up	27-828553A97	N/A	N/A	N/A
30 JET (50 hp)(3 cyl)	BEL 9973100 and up	27-828553A97	N/A	N/A	N/A

**Not all parts listed are available for the European, C.I.S., Africa and Middle East Markets.  
For more information, please contact your local Mercury, Mariner, MerCruiser or Quicksilver Office.**

# POWERHEAD COMPONENTS

Model	Serial # Range	Gasket Set	Head O-Rings	Head Gaskets	Head Seals
35 (350, 35A)	127884 and up	N.L.A.	N/A	N/A	N/A
35 (2 cyl)	USA 6445653 - 0B110788	27-78028A78	N/A	N/A	N/A
35 (2 cyl)	BEL 9384476 - 9466646	27-78028A78	N/A	N/A	N/A
35 (2 cyl)	CAN 7209608 and up	27-78028A78	N/A	N/A	N/A
35 (2 cyl)	USA 0B110789 and up	N.L.A.	N/A	N/A	N/A
35 (2 cyl)	BEL 9466647 and up	N.L.A.	N/A	N/A	N/A
40 (400)	1279685 - 3336257	N.L.A.	N/A	N/A	N/A
40 (40, 402)(2 cyl.)	USA 3336258 - 0G053313	27-78028A78	N/A	N/A	N/A
40 (40, 402)(2 cyl.)	AUS 8002335 and up	27-78028A78	N/A	N/A	N/A
40 (40, 402)(2 cyl.)	BEL 3339688 and up	27-78028A78	N/A	N/A	N/A
40 (2 cyl)	CAN 3340783 and up	27-78028A78	N/A	N/A	N/A
40 (2 cyl)(644cc)	USA 0G053314 and up	27-822420A94	N/A	N/A	N/A
40 (4 cyl)	USA 0C159200 and up	27-85491A90	N/A	N/A	N/A
40 (4 cyl)	BEL 9570790 and up	27-85491A90	N/A	N/A	N/A
40 (3 cyl)	USA 0G531301 and up	27-828553A97	N/A	N/A	N/A
40 (3 cyl)	BEL 9973100 and up	27-828553A97	N/A	N/A	N/A
40 Italy (4-Stroke)	USA 0G231123 - 0T178499	27-832013A96	N/A	27-825032	N/A
40 (4-Stroke)(3 cyl) Carb	USA 0G760300 - 0T408999	27-825231A99	N/A	27-834777	N/A
40 (4-Stroke)(3 cyl) Carb	USA 0T409000 and up	27-825231A02	N/A	27-834777	N/A
40 (4-Stroke)(3 cyl) Carb	BEL 0P153500 and up	27-825231A02	N/A	27-834777	N/A
40 (4-Stroke)(3 cyl) EFI	USA 0T409000 and up	27-859352A02	N/A	27-834777	N/A
40 (4-Stroke)(3 cyl) EFI	CHN 1C000001 and up	27-859352A02	N/A	27-834777	N/A
40 (4-Stroke)(4 cyl) Carb	USA 0T228405 - 0T598999	27-859352A01	N/A	27-8M0045278	N/A
40 (4-Stroke)(4 cyl) EFI	USA 0T409000 and up	27-883599A02	N/A	27-8M0045278	N/A
40 (4-Stroke)(4 cyl) EFI	CHN 1C000001 and up	27-883599A02	N/A	27-8M0045278	N/A
45 (4 cyl)	USA 5531630 - 0B110788	N.L.A.	N/A	N/A	N/A
45 (4 cyl)	AUS 8063985 and up	N.L.A.	N/A	N/A	N/A
45 (4 cyl)	BEL 9248006 - 9466691	N.L.A.	N/A	N/A	N/A
45 (4 cyl)	CAN 7143688 - 0A719280	N.L.A.	N/A	N/A	N/A
45 (4 cyl)	USA 0B110789 and up	27-85491A90	N/A	N/A	N/A
45 (4 cyl)	BEL 9466692 and up	27-85491A90	N/A	N/A	N/A
45 (4 cyl)	CAN 0A719281 and up	27-85491A90	N/A	N/A	N/A
45 JET	USA 0D000750 and up	27-812867A97	N/A	N/A	N/A
450	1476510 - 1531568	N.L.A.	N/A	N/A	N/A
45 Bodensee(4-Stroke)	USA 0G231123 - 0T178499	27-832013A96	N/A	27-825032	N/A
50 (500) (4 cyl)	1421113 - 2116317	N.L.A.	N/A	N/A	N/A
50 (500) (4 cyl)	CAN 1755549 - 2097444	N.L.A.	N/A	N/A	N/A
50 (500) (4 cyl)	USA 2116318 and up	N.L.A.	N/A	N/A	N/A
50 (500) (4 cyl)	CAN 2097445 and up	N.L.A.	N/A	N/A	N/A
50 (500) (4 cyl)	AUS 2863739 and up	N.L.A.	N/A	N/A	N/A
50 (500) (4 cyl)	BEL 9001581 and up	N.L.A.	N/A	N/A	N/A
50 (3cyl)	USA 6428681 - 0B122929	27-88449A32	N/A	N/A	N/A
50 (3cyl)	BEL 9385911 - 9469199	27-88449A32	N/A	N/A	N/A
50 (3cyl)	CAN 7208333 - 0A721307	27-88449A32	N/A	N/A	N/A
50 (3cyl)	USA 0B122930 - 0D000749	27-43779A87	N/A	N/A	N/A
50 (3cyl)	BEL 9469200 - 9683054	27-43779A87	N/A	N/A	N/A
50 (3cyl)	CAN 0A721308 and up	27-43779A87	N/A	N/A	N/A
50 (3cyl)	USA 0D000750 - 0G589999	27-812867A97	N/A	N/A	N/A
50 (3cyl)	BEL 9683055 - 9973099	27-812867A97	N/A	N/A	N/A
50 (3cyl)	USA 0G590000 and up	27-828553A97	N/A	N/A	N/A
50 (3cyl)	BEL 9973100 and up	27-828553A97	N/A	N/A	N/A
50 FourStroke	USA 0G231123 - 0T178499	27-832013A96	N/A	27-825032	N/A
50 FourStroke	BEL 9944807 - 0P095599	27-832013A96	N/A	27-825032	N/A
50 (4-Stroke)(4 cyl) Carb	USA 0T178500 - 0T598999	27-859352A01	N/A	27-8M0045278	N/A

# POWERHEAD COMPONENTS

Model	Serial # Range	Gasket Set	Head O-Rings	Head Gaskets	Head Seals
50 (4-Stroke)(4 cyl) Carb	BEL 0P094500 - 0P206999	27-859352A01	N/A	27-8M0045278	N/A
50 FourStroke (4 cyl) EFI	USA 0T409000 and up	27-883599A02	N/A	27-8M0045278	N/A
50 FourStroke (4 cyl) EFI	BEL 0P153500 and up	27-883599A02	N/A	27-8M0045278	N/A
50 FourStroke (4 cyl) EFI	CHN 1C000001 and up	27-883599A02	N/A	27-8M0045278	N/A
55 (3cyl)	USA 6428681 - 0B122929	27- 88449A32	N/A	N/A	N/A
55 (3cyl)	BEL 9385911 - 9469199	27- 88449A32	N/A	N/A	N/A
55 (3cyl)	CAN 7208333 - 0A721307	27- 88449A32	N/A	N/A	N/A
55 (3cyl)	USA 0B122930 - 0D000749	27- 43779A87	N/A	N/A	N/A
55 (3cyl)	BEL 9469200 - 9683054	27- 43779A87	N/A	N/A	N/A
55 (3cyl)	CAN 0A721308 and up	27- 43779A87	N/A	N/A	N/A
55 (3cyl)	USA 0D000750 and up	27-812867A97	N/A	N/A	N/A
55 (3cyl)	BEL 9683055 and up	27-812867A97	N/A	N/A	N/A
60 (600) (6 cyl)	1303411 - 1542744	N.L.A.	N/A	N/A	N/A
60 (3cyl)	USA 6428681 - 0B122929	27- 88449A32	N/A	N/A	N/A
60 (3cyl)	BEL 9385911 - 9469199	27- 88449A32	N/A	N/A	N/A
60 (3cyl)	CAN 7208333 - 0A721307	27- 88449A32	N/A	N/A	N/A
60 (3cyl)	USA 0B122930 - 0D000749	27- 43779A87	N/A	N/A	N/A
60 (3cyl)	BEL 9469200 - 9683054	27- 43779A87	N/A	N/A	N/A
60 (3cyl)	CAN 0A721308 and up	27- 43779A87	N/A	N/A	N/A
60 (3cyl)	USA 0D000750 and up	27-812867A97	N/A	N/A	N/A
60 (3cyl)	BEL 9683055 and up	27-812867A97	N/A	N/A	N/A
60 (4-Stroke)(4 cyl) Carb	USA 0T178500 - 0T598999	27-859352A01	N/A	27-8M0045278	N/A
60 (4-Stroke)(4 cyl) Carb	BEL 0P094500 - 0P206999	27-859352A01	N/A	27-8M0045278	N/A
60 (4-Stroke)(4 cyl) EFI	USA 0T409000 and up	27-883599A02	N/A	27-8M0045278	N/A
60 FourStroke (4 cyl) EFI	BEL 0P153500 and up	27-883599A02	N/A	27-8M0045278	N/A
60 FourStroke (4 cyl) EFI	CHN 1C000001 and up	27-883599A02	N/A	27-8M0045278	N/A
65 (650) (4 cyl)	1542745 - 1765043	N.L.A.	N/A	N/A	N/A
65 (650) (4 cyl)	1765044 - 3293183	N.L.A.	N/A	N/A	N/A
65 (650)(3 cyl)	USA 3293184 - 4382056	N.L.A.	N/A	N/A	N/A
65 (650)(3 cyl)	AUS 8006640 - 8042349	N.L.A.	N/A	N/A	N/A
65 (650)(3 cyl)	BEL 9020074 - 9112988	N.L.A.	N/A	N/A	N/A
65 (650)(3 cyl)	CAN 7013633 - 7073472	N.L.A.	N/A	N/A	N/A
65 (650)(3 cyl)	USA 4382057 - 4571651	27- 88449A32	N/A	N/A	N/A
65 (650)(3 cyl)	BEL 9112989 - 9135824	27- 88449A32	N/A	N/A	N/A
65 (650)(3 cyl)	CAN 7073473 - 7087822	27- 88449A32	N/A	N/A	N/A
70 (700) (6 cyl)	1296411 - 1566239	N.L.A.	N/A	N/A	N/A
70 (3 cyl)	USA 4571652 - 0A996141	27- 88449A32	N/A	N/A	N/A
70 (3 cyl)	AUS 8042350 and up	27- 88449A32	N/A	N/A	N/A
70 (3 cyl)	BEL 9135825 - 9385910	27- 88449A32	N/A	N/A	N/A
70 (3 cyl)	CAN 7087823 - 7208332	27- 88449A32	N/A	N/A	N/A
70 (3 cyl)	USA 0A996142 and up	27- 43004A99	N/A	N/A	N/A
70 (3 cyl)	BEL 9483121 and up	27- 43004A99	N/A	N/A	N/A
75 (4 cyl)	USA 6432901 and up	27- 73645A87	N/A	N/A	N/A
75 (4 cyl)	BEL 9393856 and up	27- 73645A87	N/A	N/A	N/A
75 (4 cyl)	CAN 7208573 and up	27- 73645A87	N/A	N/A	N/A
75 (3 cyl) Optimax	USA 0T801000 and up	27-879855A04	N/A	N/A	N/A
75 (4-Stroke)(Carb)	USA 0G960500 - 1B226999	27-804345A02	N/A	27-804115 1	N/A
75 FourStroke (EFI)(1596cc)	USA 1B172291 - 1B366822	27-858732A03	N/A	27-804115 1	N/A
75/80 FourStroke (EFI)(1731cc)	USA 1B366823 - 2B094995	27-897534A07	N/A	27-8M0024565	N/A
75/80 FourStroke (2.1L)	USA 2B094996 and up		N/A	27-8M0090776	N/A
80 (800)(6 cyl)	1335465 - 1566239	N.L.A.	N/A	N/A	N/A
80 (80,800)(4 cyl)	2559001 - 3493912	N.L.A.	N/A	N/A	N/A

Not all parts listed are available for the European, C.I.S., Africa and Middle East Markets.  
 For more information, please contact your local Mercury, Mariner, MerCruiser or Quicksilver Office.

# POWERHEAD COMPONENTS

Model	Serial # Range	Gasket Set	Head O-Rings	Head Gaskets	Head Seals
80 (80,800)(4 cyl)	USA 4831999 - 6432900	27- 73645A87	N/A	N/A	N/A
80 (80,800)(4 cyl)	AUS 8050200 and up	27- 73645A87	N/A	N/A	N/A
80 (80,800)(4 cyl)	BEL 9177626 - 9393855	27- 73645A87	N/A	N/A	N/A
80 (80,800)(4 cyl)	CAN 7110998 - 7208572	27- 73645A87	N/A	N/A	N/A
80 (3 cyl)	USA 0A996142 and up	27- 43004A99	N/A	N/A	N/A
80 (3 cyl)	BEL 9483121 and up	27- 43004A99	N/A	N/A	N/A
80 JET (4 cyl)	USA 0D283222 and up	27- 13461A99	N/A	N/A	N/A
80 JET (4 cyl)	BEL 9793577 and up	27- 13461A99	N/A	N/A	N/A
90 (900)(6 cyl)	1766824 - 1869775	N.L.A.	N/A	N/A	N/A
90 (90, 900)(6 cyl)	USA 4845301 and up	27- 85653A87	N/A	N/A	N/A
90 (90, 900)(6 cyl)	CAN 7111698 and up	27- 85653A87	N/A	N/A	N/A
90 (90, 900)(6 cyl)	AUS 8060545 and up	27- 85653A87	N/A	N/A	N/A
90 (3 cyl)	USA 0A996142 and up	27- 43004A99	N/A	N/A	N/A
90 (3 cyl)	BEL 9483121 and up	27- 43004A99	N/A	N/A	N/A
90 (3 cyl) Optimax	USA 0T801000 and up	27-879855A04	N/A	N/A	N/A
90 (4-Stroke)	USA 0G960500 - 1B226999	27-804345A02	N/A	27-804115 1	N/A
90 FourStroke (EFI)(1596cc)	USA 1B172291 - 1B366822	27-858732A03	N/A	27-804115 1	N/A
90/100 FourStroke (EFI)(1731cc)	USA 1B366823 - 2B094995	27-897534A07	N/A	27-8M0024565	N/A
90/100 FourStroke (2.1L)	USA 2B094996 and up		N/A	27-8M0090776	N/A
95 (950)(6 cyl)	1869776 - 2318585	N.L.A.	N/A	N/A	N/A
100 (1000)(6 cyl)	1464949 - 1768403	N.L.A.	N/A	N/A	N/A
100 (1000)(6 cyl)	1768404 - 2641854	N.L.A.	N/A	N/A	N/A
100 (1000)(6 cyl)	2641855 - 3253111	N.L.A.	N/A	N/A	N/A
100 (4 cyl)	USA 0B209468 and up	27- 13461A99	N/A	N/A	N/A
100 (4 cyl)	BEL 9523034 and up	27- 13461A99	N/A	N/A	N/A
105 JET (V-6)	USA 0D082000 and up	27-815791A92(1)	N/A	27- 18785T(1)	N/A
110 (1100)(6 cyl)	1870204 - 2314955	N.L.A.	N/A	N/A	N/A
115 (115, 1150)(6 cyl)	2836019 - 3525440	27- 55284A 1	N/A	N/A	N/A
115 (115, 1150)(6 cyl)	USA 3525441 and up	27- 85653A87	N/A	N/A	N/A
115 (115, 1150)(6 cyl)	AUS 8008665 and up	27- 85653A87	N/A	N/A	N/A
115 (115, 1150)(6 cyl)	CAN 7112248 and up	27- 85653A87	N/A	N/A	N/A
115 (4 cyl)	USA 0C100000 and up	27- 13461A99	N/A	N/A	N/A
115 (4 cyl)	BEL 9559771 and up	27- 13461A99	N/A	N/A	N/A
115 (3 cyl) Optimax	USA 0T801000 and up	27-879855A04	N/A	N/A	N/A
115 Pro XS	USA 1B751825 and up	27-879855A04	N/A	N/A	N/A
115 FourStroke (EFI)(1741cc)	USA 0T209000 - 1B366822	27-858732T02	N/A	27-804115 1	N/A
115 FourStroke (EFI)(1731cc)	USA 1B366823 - 2B094995	27-897534A07	N/A	27-8M0024565	N/A
115 FourStroke (2.1L)	USA 2B094996 and up		N/A	27-8M0090776	N/A
1250 (6 cyl)	ALL and up	N.L.A.	N/A	N/A	N/A
125 (4 cyl)	USA 0D283222 and up	27- 13461A99	N/A	N/A	N/A
125 (4 cyl)	BEL 9793577 and up	27- 13461A99	N/A	N/A	N/A
125 (3 cyl) Optimax	USA 1B736885 and up	27-879855A04	N/A	N/A	N/A
135 (1350)(6 cyl)	ALL and up	27- 55284A 1	N/A	N/A	N/A
140 (140, 1400)(6 cyl)	USA 3293234 - 3502805	27- 85653A87	N/A	N/A	N/A
140 (140, 1400)(6 cyl)	USA 4865678 and up	27- 85653A87	N/A	N/A	N/A
140 (140, 1400)(6 cyl)	AUS 8052650 and up	27- 85653A87	N/A	N/A	N/A
140 (140, 1400)(6 cyl)	CAN 7112773 and up	27- 85653A87	N/A	N/A	N/A
150 (1500)(6 cyl)	USA 3502806 - 5327662	27- 85653A87	N/A	N/A	N/A
150 (1500)(6 cyl)	AUS 8005615 - 8052649	27- 85653A87	N/A	N/A	N/A
150 (1500)(6 cyl)	CAN 7010533 - 7112772	27- 85653A87	N/A	N/A	N/A
V-135	USA 0A904646 - 0C239552	27- 90484A88	N/A	27- 96281T01	N/A
V-135	USA 0C239553 - 0G960499	27-815791A92(1)	N/A	27- 18785T(1)	N/A
V-135	USA 0G960500 - 0T178499	27-815791A00(1)	N/A	27- 18785T(1)	N/A

# POWERHEAD COMPONENTS

Model		Serial # Range	Gasket Set	Head O-Rings	Head Gaskets	Head Seals
V-135 DFI	USA	0G590000 - 0G960499	27-8M0046714(1)	N/A	27-852520 3(1)	N/A
V-135 DFI	USA	0G960500 and up	27-8M0046714(2)	859772 1(2)	N/A	858452 1(2)
135 Verado	USA	1B227000 and up	27-896142A07	N/A	27-8M0024565	N/A
	BEL	0P419487 and up				
V-140 JET	USA	0D082000 - 0G960499	27-815791A92(1)	N/A	27-822844T05(1)	N/A
V-150 (150, 1500)	USA	4868998 - 6042945	N.L.A.	N/A	27- 79583 1	N/A
V-150	USA	6042946 - 0C239552	27- 90484A88	N/A	27- 96281T01	N/A
V-150	USA	0C239553 - 0G960499	27-815791A92(1)	N/A	27- 18785T(1)	N/A
V-150	USA	0G960500 and up	27-8M0046714(2)	859772 1(2)	N/A	858452 1(2)
V-150 (XR4/MAGNUM II)	USA	0B242885 - 0C239552	N.L.A.	N/A	27- 41247T01	N/A
V-150 (XR4)	USA	0C239553 - 0D081999	27-815791A92(1)	N/A	27- 18786T(1)	N/A
V-150 (XR6/MAGNUM III)	USA	0D082000 - 0G960499	27-815791A92(1)	N/A	27-822844T05(1)	N/A
V-150 (XR6/MAGNUM III)	USA	0G960500 and up	27-8M0046714(2)	859772 1(2)	N/A	858452 1(2)
V-150 EFI	USA	0D082000 - 0G960499	27-815791A92(1)	N/A	27-822844T05(1)	N/A
V-150 EFI	USA	0G960500 - 0T408999	27-815791A00(2)	859772 1(2)	N/A	858452 1(2)
V-150 EFI	USA	0T409000 and up	27-8M0046715(3)	859772 1(3)	N/A	858452 1
V-150 DFI	USA	0G590000 - 0G960499	27-8M0046714(1)	N/A	27-852520 3(1)	N/A
V-150 DFI	USA	0G960500 and up	27-8M0046714(2)	859772 1(2)	N/A	858452 1(2)
150 ProXS	USA	1B690542 and up	27-8M0046714(2)	859772 1(2)	N/A	858452 1(2)
150 EFI FourStroke	USA	1B905505 and up	27-8M0057763		27-8M6000366	
150 Verado	USA	1B227000 and up	27-896142A07	N/A	27-8M0024565	N/A
	BEL	0P419487 and up				
V-175 (175,1750)	USA	4301235 - 6618750	N.L.A.	N/A	27- 79583 1	N/A
V-175 (175,1750)	AUS	8058870 and up	N.L.A.	N/A	27- 79583 1	N/A
V-175	USA	6618751 - 0C239552	N.L.A.	N/A	27- 41247T01	N/A
V-175	USA	0C239553 - 0D081999	27-815791A92(1)	N/A	27- 18786T(1)	N/A
V-175	USA	0D082000 - 0G960499	27-815791A92(1)	N/A	27-822844T05(1)	N/A
V-175 EFI	USA	0D000750 - 0D081999	27-815791A92(1)	N/A	27- 18786T(1)	N/A
V-175 EFI	USA	0D082000 - 0G960499	27-815791A92(1)	N/A	27-822844T05(1)	N/A
V-175 EFI	USA	0G960500 - 0T408999	27-815791A00(2)	859772 1(2)	N/A	858452 1(2)
V-175 EFI	USA	0T409000 - 0T800999	27-8M0046715(3)	859772 1(3)	N/A	858452 1
V-175 DFI	USA	0T178500 and up	27-8M0046714(2)	859772 1(2)	N/A	858452 1(2)
V-175 Pro XS	USA	1B516339 and up	27-8M0046714(2)	859772 1(2)	N/A	858452 1(2)
175 Verado	USA	1B227000 and up	27-896142A07	N/A	27-8M0024565	N/A
	BEL	0P419487 and up				
V-200 (200,2000)	USA	4839034 - 6073191	N.L.A.	N/A	27- 41244T02	N/A
V-200 (200,2000)	AUS	8061595 - 8065672	N.L.A.	N/A	27- 41244T02	N/A
V-200	USA	6073192 - 6203990	27- 89221A80	N/A	27- 41244T02	N/A
V-200	USA	6203991 - 0C291519	27- 89221A88	N/A	27- 41247T01	N/A
V-200	USA	0C291520 - 0D081999	27-815791A92(1)	N/A	27-822844T05(1)	N/A
V-200	USA	0D082000 - 0G960499	27-815791A92(1)	N/A	27-822844T05(1)	N/A
V-200	USA	0G960500 and up	27-815791A00(2)	859772 1(2)	N/A	858452 1(2)
V-200 EFI	USA	0C100861 - 0C291519	27- 14697A87	N/A	27- 41247T01	N/A
V-200 EFI	USA	0C291520 - 0G960499	27-815791A92(1)	N/A	27-822844T05(1)	N/A
V-200 EFI	USA	0G960500 - 0T408999	27-815791A00(2)	859772 1(2)	N/A	858452 1(2)
V-200 EFI (2.5L)	USA	0T409000 and up	27-8M0046715(3)	859772 1(3)	N/A	858452 1
V-200 EFI (3.0L)	USA	0T750164 - 0T598999	27-832934A00(3)	878453(3)	N/A	818574
V-200 EFI (3.0L)	USA	0T599000 and up	27-832934A00(2)	884391(2)	N/A	818574
V-200 DFI (3.0L)	USA	0G386496 - 0G589999	N.L.A.	25-818573	N/A	818574
V-200 DFI (3.0L)	USA	0G590000 - 0G960499	27-832934A98(2)	25-818573(2)	N/A	818574(2)
V-200 DFI (3.0L)	USA	0G960500 - 0T178499	27-832934A00(3)	25-818573(3)	N/A	818574
V-200 DFI (3.0L)	USA	0T178500 - 0T598999	27-832934A00(3)	878453(3)	N/A	818574
V-200 DFI (3.0L)	USA	0T599000 and up	27-832934A00(3)	884391(3)	N/A	818574

Not all parts listed are available for the European, C.I.S., Africa and Middle East Markets.  
 For more information, please contact your local Mercury, Mariner, MerCruiser or Quicksilver Office.

# POWERHEAD COMPONENTS

Model	Serial # Range	Gasket Set	Head O-Rings	Head Gaskets	Head Seals
V-200 Pro XS	USA 1B504989 and up	27-832934A00(3)	884391(3)	N/A	818574
200 4 CYL., Verado	USA 1B517159 and up	27-896142A07	N/A	27-8M0024565	N/A
	BEL 0P514869 and up				
200 6 CYL., Verado	USA 0T980000 and up	27-880552A07	N/A	27-8M0033476	N/A
	BEL 0P409357 and up				
V-220	USA 0B117316 and up	27- 14697A87	N/A	27- 41247T01	N/A
V-225	USA 5628028 and up	27- 89221A80	N/A	27- 41244T02	N/A
V-225	USA 0D280813 - 0T178499	27-814195A93	25-818573	N/A	818574
V-225	USA 0T178500 - 0T408999	27-814195A93	878453	N/A	818574
V-225 SEA PRO	USA 0G245605 - 0T408999	27-814195A93	25-818573	N/A	818574
V-225 EFI (3.0L)	USA 0G129222 - 0T408999	27-814195A93	25-818573	N/A	818574
V-225 EFI (3.0L)	USA 0T409000 - 0T598999	27-832934A00(3)	878453(3)	N/A	818574
V-225 EFI (3.0L)	USA 0T599000 and up	27-832934A00(3)	884391(3)	N/A	818574
V-225 EFI (FourStroke) Starboard	USA 0T653945 - 0T807875	27-887810A03	N/A	27-887848002	N/A
V-225 EFI (FourStroke) Port	USA 0T653945 - 0T807875			27-887848003	
V-225 EFI (FourStroke) Starboard	USA 0T807876 and up	27-887810A04	N/A	27-887848002	N/A
V-225 EFI (FourStroke) Port	USA 0T807876 and up			27-887848003	
V-225 DFI (3.0L)	USA 0G590000 - 0G960499	27-832934A98(3)	25-818573(3)	N/A	818574
V-225 DFI (3.0L)	USA 0G960500 - 0T178499	27-832934A00(3)	25-818573(3)	N/A	818574
V-225 DFI (3.0L)	USA 0T178500 - 0T598999	27-832934A00(3)	878453(3)	N/A	818574
V-225 DFI (3.0L)	USA 0T599000 and up	27-832934A00(3)	884391(3)	N/A	818574
V-225 Pro XS	USA 1B104549 and up	27-841220A03(3)	884391(3)	N/A	818574
225 Verado	USA 0T980000 and up	27-880552A07	N/A	27-8M0033476	N/A
	BEL 0P409357 and up				
V-250 EFI (3.0L)	USA 0T409000 - 0T598999	27-832934A00(3)	878453(3)	N/A	818574
V-225 EFI (3.0L)	USA 0T599000 and up	27-832934A00(3)	884391(3)	N/A	818574
V-250 (3.4L)	USA 0C101891 and up	N.L.A.	N.L.A.	N/A	N.L.A.
V-250 EFI (3.0L)	USA 0G129222 - 0T408999	27-814195A93	25-818573	N/A	818574
V-250 DFI (3.0L)	USA 1B528615 and up	27-841220A03(3)	884391(3)	N/A	818574
V-250 Pro XS	USA 1B426561 and up	27-841220A03(3)	884391(3)	N/A	818574
250 Verado	USA 0T980000 and up	27-880552A07	N/A	27-8M0033476	N/A
	BEL 0P409357 and up				
V-275 (3.4L)	USA 0C101891 and up	N.L.A.	N.L.A.	N/A	N.L.A.
275 Verado	USA 0T980000 and up	27-880552A07	N/A	27-8M0033476	N/A
	BEL 0P409357 and up				
V-300 (3.4L)	USA 5611648 and up	N.L.A.	N.L.A.	N/A	N.L.A.
300 Verado	USA 1B517434 and up	27-880552A07	N/A	27-8M0033476	N/A
	BEL 0P520553 and up				

(1) Head gaskets are not included in Gasket set

(2) Cylinder head O-rings and seal not included in gasket kit.

(3) Cylinder head O-rings not included in gasket kit.

## Early Mariner Powerhead Gasket Kits

Model	SN Code	Serial # Range	PowerHead Gasket Kits
2A	646		N.L.A.
2B	6A1		N.L.A.
2B	6A1	131232 and up	N.L.A.
3.5	642		N.L.A.
4A (M)	6E0		N.L.A.
4A (ML)	6E0		N.L.A.
4A (M)	6E0	013401 - 070823	N.L.A.
4A (ML)	6E0	306026 - 325783	N.L.A.
4A (M)	6E0	070824 - 325784	N.L.A.

Model	SN Code	Serial # Range	PowerHead Gasket Kits
5A	661		N.L.A.
5C (M)	6E3		N.L.A.
5C (M)	6E3		N.L.A.
5C (ML)	6E3		N.L.A.
5C (M)	6E3	108871 - 144066	N.L.A.
5C (ML)	6E3	404901 - 425196	N.L.A.
5C (M)	6E3	144067 and up	N.L.A.
5C (ML)	6E3	425197 and up	N.L.A.
6C/D	6H8		N.L.A.
6C/D	6H6		N.L.A.



Model	SN Code	Serial # Range	PowerHead Gasket Kits
8B	677		N.L.A.
8C	6G1		N.L.A.
9.9C	682		N.L.A.
15C (M)	684		N.L.A.
15C (ML)	684		N.L.A.
15C (E)	684		N.L.A.
15C (EL)	684		N.L.A.
15C (M)	684	062459 and up	N.L.A.
15C (ML)	684	336234 and up	N.L.A.
15C (E)	684	252704 and up	N.L.A.
15C (EL)	684	553589 and up	N.L.A.
20A	653		N.L.A.
20C	6A9		N.L.A.
25A	648		N.L.A.
25C	695		N.L.A.
28	664		N.L.A.
30A (M)	689		N.L.A.
30A (ML)	689		N.L.A.
30A (E)	689		N.L.A.
30A (EL)	689		N.L.A.
30A (M)	689	010646 - 230100	N.L.A.
30A (ML)	689	311476 - 530100	N.L.A.
30A (E)	689	102356 - 250100	N.L.A.
30A (EL)	689	405456 - 550100	N.L.A.
30A (M)	689	0230101 and up	N.L.A.
30A (ML)	689	530101 and up	N.L.A.
30A (E)	689	250101 and up	N.L.A.
30A (EL)	689	550101 and up	N.L.A.
40A/B	676		N.L.A.
40 (M)	6E9		N.L.A.
40 (ML)	6E9		N.L.A.
40 (E)	6E9		N.L.A.
40 (EL)	6E9		N.L.A.
40 (M)	6E9	015001 and up	N.L.A.
40 (ML)	6E9	350001 and up	N.L.A.
40 (E)	6E9	150001 and up	N.L.A.
40 (EL)	6E9	450001 and up	N.L.A.
48/W48	670		27- 84168M
55/W55	663		27- 84168M
60	675		27- 84168M
60	6F0		N.L.A.

# GEAR CASE COMPONENTS

## GEAR CASE COMPONENTS

### POINT OF SALE DRAIN SCREWS AND SEALS

#### FILL AND DRAIN SCREW KIT



##### 22-8M0083060

Includes the screw and the tear resistant rubber coated seal.

Fits Mercury/Mariner outboards of Japanese origin that use an 8x1.25 metric threaded screw.

Mercury Branded, Clamshell Package Point of Sale Packaged.

**NEW**

##### 22-8M0083059

Includes the screw and the tear resistant rubber coated seal.

Fits Mercury/Mariner outboards of Japanese origin that use an 8x1.25 metric threaded screw.

Quicksilver Branded, Clamshell Package Point of Sale Packaged.

**NEW**

#### GEAR CASE DRAIN SCREW



##### 22-8M0058388

Magnetic screw with premium drain screw seal.

Fits Mercury MerCruiser I, R, MR, Alpha One, TR, TRS, and all outboards with Magnetic gear lube fill or vent 3/8-16 UNC threaded screws.

Priced individually, sold @ multiples of 2

Mercury Branded, Clamshell Package Point of Sale Packaged.

##### 22-8M0058389

Magnetic screw with premium drain screw seal.

Fits Mercury MerCruiser I, R, MR, Alpha One, TR, TRS, and all outboards with Magnetic gear lube fill or vent 3/8-16 UNC threaded screws.

Priced individually, sold @ multiples of 2

Quicksilver Branded, Clamshell Package Point of Sale Packaged.

#### DRAIN SCREW SEAL



##### 26-8M0058390

A superior seal with resistance to tearing, cracking or splitting. There are 2 seals included in each clamshell's individual price.

Used with the gear case 3/8-16 drain/fill screw found on all Mercury MerCruiser and most Mercury Outboards except those of Japanese origin.

Priced individually, sold @ multiples of 2

Mercury Branded, Clamshell Package Point of Sale Packaged.

##### 26-8M0058391

A superior seal with resistance to tearing, cracking or splitting. There are 2 seals included in each clamshell's individual price.

Used with the gear case 3/8-16 drain/fill screw found on all Mercury MerCruiser and most Mercury Outboards except those of Japanese origin.

Priced individually, sold @ multiples of 2

Quicksilver Branded, Clamshell Package Point of Sale Packaged.

#### DRAIN SCREW GASKET



##### 12- 19183K02

There are 4 gaskets included in each clamshell's individual price.

Used with the 3/8-16 drain/fill screw found on all MerCruiser and most Mercury/ Mariner outboards except Verado and those of Japanese origin.

Priced individually, sold @ multiples of 2

Mercury Branded, Clamshell Package Point of Sale Packaged.

##### 12- 19183Q02

There are 4 gaskets included in each clamshell's individual price.

Used with the 3/8-16 drain/fill screw found on all MerCruiser and most Mercury/ Mariner outboards except Verado and those of Japanese origin.

Priced individually, sold @ multiples of 2

Quicksilver Branded, Clamshell Package Point of Sale Packaged.

**FRONT WATER INLET PLUG KITS**

**WATER INLET PLUG KIT**



**895764A01**

Contains two plugs, o-ring and shift shaft gasket.  
Plugs the front low water pick-up on the gearcase for the 3.0L EFI/Optimax outboards with the shift shaft bushing assembly that is fastened with 2 screws.

**WATER INLET PLUG KIT**



**8M0052921**

Contains plugs and gasket to seal the low water pickups from injecting debris into the engine water cooling passages.  
Fits the Verado gearcase and the Torquemaster II with the shift shaft bushing fastened with 4 screws.

**LOWER UNIT SEAL KITS**

**SEAL KIT**

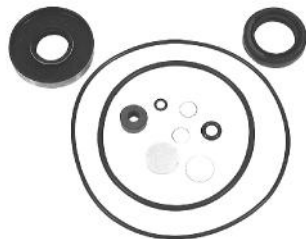

**FK1061**

**SEAL KIT**



**FK1063-2**

**SEAL KIT**



**26- 41365A 3**

**SEAL KIT**



**26- 43035A 4**

Fits Mercury/Mariner 100/115/125 hp. 2-cycle outboard (USA 0B209468 and Newer, BEL 9523034) with either 3 or 6 jaw reverse clutch.

**SEAL KIT**



**26- 43035A05**

**SEAL KIT**



**26- 55682A 1**

**GEAR CASE COMPONENTS**

**SEAL KIT**



26- 66303A 1

**GASKET SET**

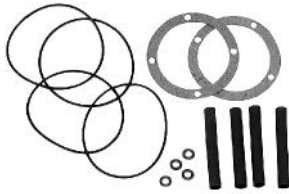

27- 72863A88

**SEAL KIT**



26- 77066A 1

**SEAL KIT**



26- 79831A 1

**SEAL KIT**



26- 85090A 2

**SEAL KIT**



26- 89238A 2

Fits Mercury / Mariner 135/150 V-6 outboards (USA 0A904646 and Newer) and 175/200 V-6 outboards (USA 6618751 and Newer).

**GASKET SET**



27- 96324M

Seals a lower unit gearcase.  
Fits Mariner models 4A and 5C outboards. See chart for specific engine applications.

**SEAL KIT**



26-814669A 2

**SEAL KIT**



26-816575A 4

Gear Housing

SEAL KIT



26-816575A 5

SEAL KIT



26-820645A 1

SEAL KIT



823547A 2

SEAL KIT



823547A03

SEAL KIT



26-830749A01

Fits the 4.80 inch Torpedo gearcase on the FourStroke Verado outboard beginning with Model Year 2005.

SEAL KIT

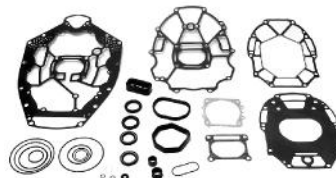

27-888658A03

SEAL KIT

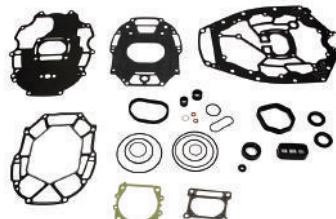

27-888658A04

LOWER UNIT GASKET SET



27-804908A01

Fits the F25/30 EFI FourStroke outboards 0R106999-0R515209.

# GEAR CASE COMPONENTS

## SEAL KIT



**8M0057716**

Fits Mercury/Mariner 150 EFI FourStroke outboards beginning with serial number 1B905505 and above.

## SEAL KIT



**8M0065064**

Fits the 5.44 inch Torpedo diameter gearcase on a 6 cylinder FourStroke Verado outboard.

## SEAL KIT



**27-8M0077448**

Seals a lower unit gearcase.  
Fits the 20 hp. FourStroke outboard, 0R235168 and above and the 15 hp. FourStroke outboard, 0R235949 and above.

## SEAL KIT



**27-8M0082878**

## SEAL KIT



**27-8M0082881**

Fits the 2.5/3.5 hp. FourStroke outboard, serial number 0R131842 & above.

## SEAL KIT

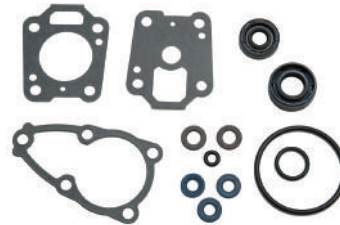

**27-8M0082882**

## LOWER UNIT GASKET SET

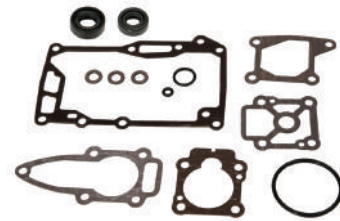

**27-8M0082883**

## LOWER UNIT GASKET SET



**27-8M0082884**

## SEAL KIT

Image not Available.

**8M0088080**

Gearhousing seal kit.  
Fits the Standard gearcase on the Mercury/Mariner F75-115 (2.1L) FourStroke outboard (s/n USA 2B094996 and above).

## 8M0088081

Gearhousing seal kit.  
Fits the Command Thrust gearcase on the Mercury/Mariner F75-115 (2.1L) FourStroke outboard (s/n USA 2B094996 and above).

## LOWER UNIT SEAL KIT APPLICATION CHARTS

### Mercury/Mariner Lower Unit Seal Kits

Model	Model Notes	Serial # Range	Lower Unit Seal Kit
2.5		0A855097 and up	27-8M0082878
2.5 FourStroke		JPN 0R131842 and up	27-8M0082881
3		0A855097 and up	27-8M0082878
3.3	NON-SHIFT	0D901217 and up	27-8M0082878
3.3	SHIFT	0D901217 and up	27-8M0082878
3.5	Water Cooled	USA 6202173 and up	N.L.A.
3.5 FourStroke		JPN 0R131842 and up	27-8M0082881
3.6	Water Cooled	USA 5404657 and up	N.L.A.
		BEL 9252831 and up	
		CAN 7145388 and up	
4	1 cylinder.	USA 5595532 - 0A809600	26- 77066A 1
		AUS 8068065 and up	
		BEL 9258281 - 9477829	
		CAN 7143688 and up	
4	1 cylinder.	USA 0A855097 - 0G710612	27-8M0082882
		BEL 9589154 - 0P016999	
4	2 cylinder.	USA 5589202 - 5595531	N.L.A.
		AUS 8065265 - 8068064	
		BEL 9256981 - 9258280	
		CAN 7146488 - 7143687	
4 FourStroke		JPN 0R000001 and up	27-8M0082882
		BEL 0P073456 and up	
4.5	1 cylinder.	USA 4107220 - 0A809600	26- 77066A 1
		AUS 8026540 and up	
		BEL 9072179 - 9477829	
		CAN 7045758 and up	
5	1 cylinder.	USA 0A855097 and up	27-8M0082882
		BEL 9589154 and up	
5 FourStroke		JPN 0R000001 and up	27-8M0082882
		BEL 0P073456 and up	
6		USA 0A197112 - 0T800749	26- 41365A 3
		BEL 9461526 and up	
6 FourStroke		JPN 0R000001 and up	27-8M0082882
		BEL 0P073456 and up	
7.5	(7.5, 75)	USA 4851693 - 0A197111	26- 77066A 1
		AUS 8051350 and up	
		BEL 9181726 - 9461525	
		CAN 7111898 and up	
8		USA 0A197112 and up	26- 41365A 3
		BEL 9461526 and up	
8 FourStroke		USA 0H000058 - 0H017349	26- 41365A 3
8 FourStroke		USA 0G760300 - 0T178499	26- 41365A 3
		BEL 0P086824 - 0P325499	
8 FourStroke		JPN 0R042475 and up	27-8M0082883
		BEL 0P325500 and up	

Model	Model Notes	Serial # Range	Lower Unit Seal Kit
9.8	(9.8, 110)	USA 4839254 - 0A197111	26- 77066A 1
		AUS 8050625 and up	
		BEL 9165303 - 9461525	
		CAN 7111348 and up	
9.9		USA 0A197112 and up	26- 41365A 3
		BEL 9461526 and up	
9.9 FourStroke		USA 0H000058 - 0H017349	26- 41365A 3
9.9 FourStroke	Standard Gearcase	USA 0G760300 - 0T979999	26- 41365A 3
9.9 FourStroke	Bigfoot Gearcase	USA 0G760300 - 0T979999	26- 85090A 2
		BEL 0P075166 - 0P325499	
9.9 FourStroke	Standard Gearcase	JPN 0R042475 and up	27-8M0082883
		BEL 0P325500 and up	
9.9 FourStroke	BigFoot Gearcase	JPN 0R042475 and up	27-8M0082884
		BEL 0P325500 and up	
10	(XR 10/Sea Pro 10)	USA 0D038000 and up	26- 41365A 3
		BEL 9596000 and up	
10	Magnum/Marathon	USA 0D038000 and up	26- 41365A 3
		BEL 9596000 and up	
15	(15, 15 Sea Pro/Marathon)	USA 0B292414 and up	26- 41365A 3
		BEL 9542620 and up	
15	(15XD Sea Pro/Marathon)	BEL 9927000 and up	26- 85090A 2
15	Super 15	USA 0B238464 and up	26- 85090A 2
		BEL 9507381 and up	
		CAN 0A730007 and up	
15 FourStroke	Standard Gearcase, 323cc	USA 0G590000 - 1B727495	26- 41365A 3
		BEL 0P075166 and up	
15 FourStroke	Bigfoot Gearcase, 323cc	USA 0G590000 - 1B727495	26- 85090A 2
		BEL 0P075166 and up	
15 FourStroke	351cc	JPN 0R235949 and up	27-8M0077448
18		USA 5837437 - 6443972	N.L.A.
		8071973 and up	
		BEL 9308306 - 9415100	
		CAN 7173723 - 7209532	
18	(18XD)	USA 6443973 and up	26- 85090A 2
		BEL 9378151 and up	
		CAN 7209533 and up	
20	(20, 200)	USA 4709593 - 6443972	26- 66303A 1
		AUS 8045199 and up	
		BEL 9157230 - 9415100	
		CAN 7098523 - 7209532	
20	(20, 20XD)	USA 6443973 - 0T800749	26- 85090A 2
		BEL 9415101 and up	
		CAN 7209533 and up	
20 FourStroke		JPN 0R235168 and up	27-8M0077448
25		USA 5705532 - 6443972	N.L.A.
		8073158 and up	
		BEL 9315316 - 9415100	
		CAN 7166928 - 7209532	
25 (25, 25XD)	(25, 25XD)	USA 6416713 and up	26- 85090A 2
		BEL 9378116 and up	
		CAN 7207858 and up	
25	2 cylinder	JPN 0N018456 - 0N187190	27- 95220A 1
25	3 cylinder Lightning	JPN 0E268781 - 0E287999	26- 85090A 2

Not all parts listed are available for the European, C.I.S., Africa and Middle East Markets.  
For more information, please contact your local Mercury, Mariner, MerCruiser or Quicksilver Office.



# GEAR CASE COMPONENTS

Model	Model Notes	Serial # Range	Lower Unit Seal Kit
25 FourStroke		USA 0G590000 - 0T408999	823547A 2
		BEL 9973100 - 0P153499	
25 FourStroke	Carb Models	USA 0T409000 - 1B226999	823547A03
		BEL 0P153500 - 0P400999	
25 FourStroke	EFI Models	JPN 0R106999 - 0R515209	27-804908A01
		BEL 0P401000 and up	
30	2 cylinder.	USA 0G053314 - 0T800759	823547A 2
		BEL 9854537 - 0P267999	
30	2 cylinder	JPN 0N001875 - 0N187190	27- 95220A 1
30 FourStroke	3 cylinder. Standard Gearcase	USA 0G760300 - 0T408999	823547A 2
		BEL 0P094500 - 0P153499	
30 FourStroke	3 cylinder. Standard Gearcase	USA 0T409000 - 1B226999	823547A03
		BEL 0P153500 - 0P400999	
30 FourStroke	3 cylinder. Bigfoot Gearcase	USA 0G760300 - 0T408999	26- 43035A 4
		BEL 0P094500 - 0P153499	
30 FourStroke	3 cylinder. Bigfoot Gearcase	USA 0T409000 - 1B226999	26- 43035A05
		BEL 0P153500 - 0P400999	
30 FourStroke	EFI Models	JPN 0R106999 - 0R515209	27-804908A01
		BEL 0P401000 and up	
35	2 cylinder	USA 6445653 and up	26- 79831A 1
		BEL 9384476 and up	
		CAN 7209608 and up	
40	2 cylinder	USA 4860103 - 6445652	26- 79831A 1
		AUS 8052125 and up	
		BEL 9184451 - 9415100	
		CAN 7112423 - 7209608	
40	2 cylinder	USA 0G053314 - 0T800749	823547A 2
		BEL 9854537 - 0P267999	
40	3 cylinder	USA 0G531301 and up	823547A 2
		BEL 9973100 and up	
40	4 cylinder	USA 0C159200 - 0G589999	26- 79831A 1
		BEL 9570790 - 9973099	
40 FourStroke	3 cylinder. Standard Gearcase	USA 0G760300 - 0T408999	823547A 2
		BEL 0P094500 - 0P153499	
40 FourStroke	3 cylinder. Standard Gearcase	USA 0T409000 - 1B226999	823547A03
		BEL 0P153500 - 0P400999	
40 FourStroke	3 cylinder. Bigfoot Gearcase	USA 0G760300 - 0T408999	26- 43035A 4
		BEL 0P094500 - 0P153499	
40 FourStroke	3 cylinder. Short Shaft	USA 1B227000 - 1B344398	823547A03
		BEL 0P153500 - 0P515896	
		CHN 1C000001 - 1C049738	
40 FourStroke	3 cylinder. Long Shaft	CHN 1C000001 - 1C049738	26-814669A 2
		BEL 0P401000 - 0P515896	
40 FourStroke	3 cylinder	CHN 1C049739 and up	26-814669A 2
40 FourStroke	4 cylinder Carb, Standard, Vertical Shift	USA 0G231123 - 0T598999	823547A 2
		BEL 9944807 - 0P106999	
40 FourStroke	4 cylinder Carb, Standard, Rotary Shift	USA 0T178500 - 0T598999	26-814669A 2
		BEL 0P094500 - 0P206999	
40 FourStroke	4 cylinder Carb, Bigfoot	USA 0G231123 - 0T598999	26- 43035A 4

Model	Model Notes	Serial # Range	Lower Unit Seal Kit
		BEL 9944807 - 0P206999	
40 FourStroke	4 cylinder EFI, Standard	USA 0T409000 - 1B344306	26-814669A 2
		BEL 0P153500 and up	
		CHN 1C000001 and up	
40 FourStroke	4 cylinder EFI, Bigfoot	USA 0T409000 - 1B344306	26- 43035A05
		BEL 0P153500 and up	
		CHN 1C000001 - 1C033810	
40 FourStroke	4 cylinder EFI, Bigfoot	CHN 1C033811 - 1C050251	26- 43035A 4
40 FourStroke	4 cylinder EFI, Bigfoot	CHN 1C050252 and up	26- 43035A05
45	4 cylinder.	USA 5531630 and up	26- 79831A 1
		AUS 8063985 and up	
		BEL 9248006 and up	
		CAN 7143688 and up	
45 FourStroke	4 cylinder. Standard Gearcase	USA 0G231123 - 0T178499	823547A 2
		BEL 9944807 - 0P094499	
45 FourStroke	4 cylinder. Bigfoot Gearcase	USA 0G231123 - 0T178499	26- 43035A 4
		BEL 9944807 - 0P094499	
50	4 cylinder.	USA 4357640 and up	26- 79831A 1
		CAN 7068998 and up	
		AUS 8030090 and up	
		BEL 9107214 and up	
50	3 cylinder.	USA 6428681 - 0D000749	26- 79831A 1
		BEL 9385911 - 9683054	
		CAN 7208333 and up	
50	3 cylinder.	USA 0D000750 - 0G589999	26-814669A 2
		BEL 9683055 - 9973099	
50	3 cylinder.	USA 0G590000 and up	823547A 2
		BEL 9973100 and up	
50 FourStroke	4 cylinder Carb, Standard Gearcase	USA 0G231123 - 0T178499	823547A 2
		BEL 9944807 - 0P016999	
50 FourStroke	4 cylinder Carb, Standard Gearcase	USA 0T178500 - 0T598999	26-814669A 2
		BEL 0P094500 - 0P206999	
50 FourStroke	4 cylinder Carb, Bigfoot Gearcase	USA 0G231123 - 0T598999	26- 43035A 4
		BEL 9944807 - 0P206999	
50 FourStroke	4 cylinder EFI, Standard Gearcase	USA 0T409000 - 1B344306	26-814669A 2
		BEL 0P153500 and up	
		CHN 1C000001 and up	
50 FourStroke	4 cylinder EFI, Bigfoot Gearcase	USA 0T409000 - 1B344306	26- 43035A05
		BEL 0P153500 - 0P400999	
		BEL 0P515897 and up	
		CHN 1C000001 - 1C033810	
50 FourStroke	4 cylinder EFI, Bigfoot Gearcase	CHN 1C050252 and up	26- 43035A 4
		CHN 1C033811 - 1C050251	26- 43035A 4
55	3 cylinder.	USA 0D000750 and up	26-814669A 2
		BEL 9683055 and up	
60	3 cylinder.	USA 6428681 - 0D000749	26- 79831A 1
		BEL 9385911 - 9683054	
		CAN 7208333 and up	
60	3 cylinder. Standard Gearcase	USA 0D000750 and up	26-814669A 2



# GEAR CASE COMPONENTS

Model	Model Notes	Serial # Range	Lower Unit Seal Kit
		BEL 9683055 and up	
60	3 cylinder. Bigfoot Gearcase	USA 0D000750 and up	26- 43035A 4
		BEL 9683055 and up	
60 FourStroke	4 cylinder Carb, Standard Gearcase	USA 0T178500 - 0T598999	26-814669A 2
		BEL 0P094500 - 0P206999	
60 FourStroke	4 cylinder Carb, Bigfoot Gearcase	USA 0T178500 - 0T598999	26- 43035A 4
		BEL 0P094500 - 0P206999	
60 FourStroke	4 cylinder EFI, Standard Gearcase	USA 0T409000 - 1B344306	26-814669A 2
		BEL 0P153500 and up	
		CHN 1C000001 and up	
60 FourStroke	4 cylinder EFI, Bigfoot Gearcase	USA 0T409000 - 1B344306	26- 43035A05
		BEL 0P153500 - 0P400999	
		BEL 0P515897 and up	
		CHN 1C000001 - 1C033810	
		CHN 1C050252 and up	
60 FourStroke	4 cylinder EFI, Bigfoot Gearcase	CHN 1C033811 - 1C050251	26- 43035A 4
70	3 cylinder.	USA 4571652 - 0A996141	26- 79831A 1
		AUS 8042350 and up	
		BEL 9135825 - 9385910	
		CAN 7087823 - 7208332	
70	3 cylinder.	USA 0A996142 and up	26- 43035A 4
		BEL 9483121 and up	
75	3 cylinder.	USA 0C222000 and up	26- 43035A 4
		BEL 9589039 and up	
75 Optimax	3 cylinder.	USA 0T980000 and up	26- 43035A 4
75	4 cylinder.	USA 6432901 - 0B122929	26- 55682A 1
		BEL 9393856 - 9469199	
		CAN 7208573 - 0A721307	
75 FourStroke	Carb and EFI	USA 0G960500 - 2B094995	26- 43035A 4
		BEL 0P094500 and up	
75/80 FourStroke	2.1L, Standard gearcase	USA 2B094996 and up	8M0088080
75/80 FourStroke	2.1L, Command Thrust gearcase	USA 2B094996 and up	8M0088081
80	4 cylinder.	USA 4831999 - 6432900	26- 55682A 1
		AUS 8050200 and up	
		BEL 9177626 - 9393855	
		CAN 7110998 - 7208572	
80	3 cylinder.	USA 0A996142 - 0C221999	26- 43035A 4
		BEL 9483121 - 9589038	
90	6 cylinder.	USA 4845301 - 0A996141	26- 55682A 1
		CAN 7111698 and up	
		AUS 8060545 and up	
90	3 cylinder.	USA 0A996142 and up	26- 43035A 4
		BEL 9483121 and up	
90 Optimax	3 cylinder.	USA 0T980000 and up	26- 43035A 4
90 FourStroke	Carb and EFI	USA 0G960500 - 2B094995	26- 43035A 4
		BEL 0P094500 and up	
90/100 FourStroke	2.1L, Standard gearcase	USA 2B094996 and up	8M0088080
90/100 FourStroke	2.1L, Command Thrust gearcase	USA 2B094996 and up	8M0088081

Model	Model Notes	Serial # Range	Lower Unit Seal Kit
100	4 cylinder.	USA 0B209468 - 0G960499	26- 43035A 4
		BEL 9523034 - 0P058999	
115	6 cylinder.	USA 4855153 and up	26- 55682A 1
		AUS 8051950 and up	
		CAN 7112248 and up	
115	4 cylinder.	USA 0C100000 and up	26- 43035A 4
		BEL 9559771 and up	
115 Optimax	3 cylinder.	USA 0T801000 and up	26- 43035A 4
115 Pro XS		USA 1B751825 and up	26- 43035A 4
115 FourStroke	EFI	USA 0T178500 - 2B094995	26- 43035A 4
115 FourStroke	2.1L, Standard gearcase	USA 2B094996 and up	8M0088080
115 FourStroke	2.1L, Command Thrust gearcase	USA 2B094996 and up	8M0088081
125	4 cylinder.	USA 0D283222 and up	26- 43035A 4
		BEL 9793577 and up	
125 Optimax	3 cylinder	USA 1B736885 and up	26- 43035A 4
140	6 cylinder. (140, 1400)	USA 4865678 and up	26- 55682A 1
		AUS 8052650 and up	
		CAN 7112773 and up	
V-135		USA 0A904646 - 0C239552	26- 89238A 2
V-135		USA 0C239553 and up	26- 89238A 2
V-135 Optimax	DFI	USA 0G590000 and up	26- 89238A 2
135 Verado		USA 1B227000 and up	26-830749A01
V-150	(150, 1500)	USA 4868998 - 0A904645	26- 55682A 1
V-150	Carb	USA 0A904646 and up	26- 89238A 2
V-150	(XR4/Magnum II)	USA 0B242885 - 0C239552	26- 89238A 2
V-150	(XR4)	USA 0C239553 - 0D081999	26- 89238A 2
V-150	(XR6/Magnum III)	USA 0D082000 and up	26- 89238A 2
V-150	EFI	USA 0D082000 and up	26- 89238A 2
V-150 Optimax	DFI & Pro XS	USA 0G590000 and up	26- 89238A 2
150 FourStroke	EFI	USA 1B905505 and up	8M0057716
150 Verado		USA 1B227000 and up	26-830749A01
V-175	(175, 1750)	USA 4301235 - 6618750	26- 55682A 1
		AUS 8058870 and up	
V-175	Carb, EFI	USA 6618751 and up	26- 89238A 2
V-175 Optimax	DFI	USA 0T178500 and up	26- 89238A 2
V-175 Pro XS		USA 1B516339 and up	26- 89238A 2
175 Verado		USA 1B227000 and up	26-830749A01
V-200	(200, 2000)	USA 4839034 - 6625220	26- 55682A 1
		AUS 8061595 and up	
V-200	(2.5L) Carb, EFI	USA 6625221 and up	26- 89238A 2
V-200	(3.0L) EFI	USA 0T801000 and up	26-816575A 4
V-200 Optimax	(3.0L) DFI, With C-2 Casting	USA 0G386496 - 0G437999	26-816575A 5
V-200 Optimax	(3.0L) DFI, With C-3 Casting	USA 0G386496 - 0G437999	26-816575A 4
V-200 Optimax	(3.0L) DFI	USA 0G438000 - 1B504988	26-816575A 4
V-200 Optimax	(3.0L) DFI	USA 1B504989 and up	26-830749A01
V-200 Pro XS	(3.0L) DFI	USA 1B504989 and up	26-830749A01
200 Verado	4 cylinder, 4.8 inch Torpedo	USA 0T980000 and up	26-830749A01
200 Verado	6 cylinder, 4.8 inch Torpedo	USA 0T980000 and up	26-830749A01
	6 cylinder, 5.44 inch Torpedo		8M0065064

Not all parts listed are available for the European, C.I.S., Africa and Middle East Markets.  
For more information, please contact your local Mercury, Mariner, MerCruiser or Quicksilver Office.

# GEAR CASE COMPONENTS

Model	Model Notes	Serial # Range	Lower Unit Seal Kit
V-220		USA 0B117316 - 0C100860	26-89238A 2
V-225		USA 5628028 - 6042945	26-55682A 1
V-225	(3.0L)(With C-2 Casting)	USA 0D280813 - 0G437999	26-816575A 5
V-225	(3.0L)(With C-3 Casting)	USA 0D280813 - 0G437999	26-816575A 4
V-225	(3.0L)	USA 0G438000 and up	26-816575A 4
V-225	(3.0L) EFI, With C-2 Casting	USA 0G129222 - 0G437999	26-816575A 5
V-225	(3.0L) EFI, With C-3 Casting	USA 0G129222 - 0G437999	26-816575A 4
V-225	(3.0L) EFI	USA 0G438000 - 1B504988	26-816575A 4
V-225 Optimax	(3.0L) DFI	USA 0G590000 - 1B504988	26-816575A 4
V-225 Optimax	(3.0L) DFI	USA 1B504989 and up	26-830749A01
V-225 Pro XS	w/ Torque Master	USA 1B104549 - 1B752546	26-816575A 6
V-225 Pro XS		USA 1B752547 and up	26-830749A01
V-225 FourStroke	EFI	USA 0T653945 - 0T800999	27-888658A03
V-225 FourStroke	EFI	USA 0T801000 and up	27-888658A04
225 Verado	4.8 inch Torpedo	USA 0T980000 and up	26-830749A01
	5.44 inch Torpedo		8M0065064
V-250	(3.0L) EFI, With C-2 Casting	USA 0G129222 - 0G437999	26-816575A 5
V-250	(3.0L) EFI, With C-3 Casting	USA 0G129222 - 0G437999	26-816575A 4
V-250	(3.0L) EFI	USA 0G438000 - 1B504988	26-816575A 4
V-250 Pro XS	w/ Torque Master	USA 1B426561 - 1B752546	26-816575A 6
V-250 Pro XS		USA 1B752547 and up	26-830749A01
250 Verado	4.8 inch Torpedo	USA 0T980000 and up	26-830749A01
	5.44 inch Torpedo		8M0065064
275 Verado	4.8 inch Torpedo	USA 0T980000 and up	26-830749A01
	5.44 inch Torpedo		26-8M0065064
300 Verado	4.8 inch Torpedo	USA 1B517434 and up	26-830749A01
	5.44 inch Torpedo		8M0065064
350Sci Verado		USA 1B716557 and up	26-830749A02

## Early Mariner Lower Unit Seal Kits

Model	SN Code	Serial # Range	Lower Unit Seal Kit
2A	646		N.L.A.
2B (M)	6A1	000101 - 008800	N.L.A.
2B (M)	6A1	008801 - 115871	N.L.A.
2B (M)	6A1	131232 and up	N.L.A.
3.5	642		N.L.A.
4A (M)	6E0	001011 and up	27-96324M
4A (ML)	6E0	300101 and up	27-96324M
5A	661		N.L.A.
5C (M)	6E3	102151 and up	27-96324M
5C (ML)	6E3	400101 and up	27-96324M
6C (M)	6H8	000317 and up	N.L.A.
6C (ML)	6H8	300171 and up	N.L.A.
6D (M)	6H6	001302 and up	N.L.A.
6D (ML)	6H6	300406 and up	N.L.A.
8A	655		N.L.A.
8B (M)	677	000101 and up	N.L.A.
8B (ML)	677	300101 and up	N.L.A.
8C (M)	6G1	007990 and up	N.L.A.
8C (ML)	6G1	305951 and up	N.L.A.

Model	SN Code	Serial # Range	Lower Unit Seal Kit
8C (MUL)	6G1	700388 and up	N.L.A.
9.9C (M)	682	000551 - 023105	N.L.A.
9.9C (ML)	682	300826 - 328485	N.L.A.
9.9C (E)	682	250101 - 250800	N.L.A.
9.9C (EL)	682	550141 - 551715	N.L.A.
9.9C (M)	682	023106 and up	N.L.A.
9.9C (ML)	682	328486 and up	N.L.A.
9.9C (E)	682	250801 and up	N.L.A.
9.9C (EL)	682	551716 and up	N.L.A.
15A	651		N.L.A.
15C (M)	684	000101 - 013275	N.L.A.
15C (ML)	684	300101 - 312685	N.L.A.
15C (E)	684	250101 - 250805	N.L.A.
15C (EL)	684	550101 - 551255	N.L.A.
15C (M)	684	013276 and up	N.L.A.
15C (ML)	684	312686 and up	N.L.A.
15C (E)	684	250806 and up	N.L.A.
15C (EL)	684	551256 and up	N.L.A.
20A	653		N.L.A.
20C (M)	6A9	000101 - 010111	N.L.A.
20C (ML)	6A9	300101 - 306542	N.L.A.
20C (E)	6A9	250101 - 250819	N.L.A.
20C (EL)	6A9	550101 - 550693	N.L.A.
20C (M)	6A9	010112 and up	N.L.A.
20C (ML)	6A9	306543 and up	N.L.A.
20C (E)	6A9	250820 and up	N.L.A.
20C (EL)	6A9	550694 and up	N.L.A.
25A	648		N.L.A.
25C (M)	695	000101 - 023895	N.L.A.
25C (ML)	695	300101 - 318173	N.L.A.
25C (E)	695	250101 - 253861	N.L.A.
25C (EL)	695	550101 - 555959	N.L.A.
25C (M)	695	023896 and up	N.L.A.
25C (ML)	695	318174 and up	N.L.A.
25C (E)	695	253862 and up	N.L.A.
25C (EL)	695	555960 and up	N.L.A.
28	664		N.L.A.
30A (M)	689	000366 - 022058	N.L.A.
30A (ML)	689	301911 - 3213767	N.L.A.
30A (E)	689	100251 - 105324	N.L.A.
30A (EL)	689	401216 - 411946	N.L.A.
30A (M)	689	022059 and up	N.L.A.
30A (ML)	689	321377 and up	N.L.A.
30A (E)	689	105325 and up	N.L.A.
30A (EL)	689	411947 and up	N.L.A.
40A	676		N.L.A.
40B (M)	676	B000106 and up	N.L.A.
40B (ML)	676	B300101 and up	N.L.A.
40B (E)	676	B100461 and up	N.L.A.
40B (EL)	676	B400420 and up	N.L.A.
40C (M)	6E9	000106 and up	N.L.A.
40C (ML)	6E9	300126 and up	N.L.A.
40C (E)	6E9	100101 and up	N.L.A.
40C (EL)	6E9	400231 and up	N.L.A.

Model	SN Code	Serial # Range	Lower Unit Seal Kit
48	670		N.L.A.
W-48 (M)	670	002161 and up	N.L.A.
W-48 (ML)	670	311996 and up	N.L.A.
55 (M)	663	BELOW - 02730	N.L.A.
55 (ML)	663	BELOW - 34925	N.L.A.
55 (M)	663	02731 and up	N.L.A.
55 (ML)	663	34926 and up	N.L.A.
55 (E)	663	004041 and up	N.L.A.
55 (EL)	663	315379 and up	N.L.A.
W55 (ML)	663	578278 and up	N.L.A.
60 (E)	675	00101 - 001170	N.L.A.
60 (EL)	675	30101 - 304180	N.L.A.
60 (E)	675	001171 and up	N.L.A.
60 (EL)	675	304181 and up	N.L.A.
60 (E)	6F0	000101 and up	N.L.A.
60 (EL)	6F0	300311 and up	N.L.A.



**TABLE OF CONTENTS**

<b>Mercury® MerCruiser® Ignition</b> . . . . .	150	<b>Mercury® MerCruiser® Internal Engine</b> . . . . .	205
Distributor Cap and Rotor Kits . . . . .	153	Gasket Sets - Engine Overhaul . . . . .	207
Distributor Caps . . . . .	154	Head Gaskets . . . . .	211
<b>Ignition Kits and Components Chart</b> . . . . .	156	Oil Pump Pick-Up Tubes . . . . .	206
Points . . . . .	150	Oil Pumps . . . . .	205
Rotors . . . . .	151	<b>Mercury® MerCruiser® Transom</b> . . . . .	213
Tune Up Kits . . . . .	150	Drive Installation Gasket Kits . . . . .	215
<b>Mercury® MerCruiser® Electrical System</b> . . . . .	159	Engine Mounting Hardware . . . . .	213
Electrical Harness Repair Kits . . . . .	160	Gimbal Ring Kits . . . . .	213
Starter Slave Solenoids . . . . .	159	Shift Cable Bellows . . . . .	216
<b>Mercury® MerCruiser® Fuel System</b> . . . . .	163	Shift Cable Kits . . . . .	214
<b>Carburetor and Repair Parts Chart</b> . . . . .	165	Shift Cables . . . . .	214
Carburetor Gasket Kits . . . . .	164	Sterndrive Installation Hardware . . . . .	214
Carburetor Repair Kits . . . . .	163	<b>Transom Gasket and Seal Chart</b> . . . . .	216
Fuel Pumps . . . . .	170	Transom Seal Repair Kits . . . . .	216
MerCruiser Fuel Filters - Carburetor . . . . .	165	<b>Mercury® MerCruiser® Drive Systems</b> . . . . .	218
MerCruiser Fuel Filters - Fuel Pump . . . . .	173	<b>Gear Chart - Driveshaft Housing</b> . . . . .	222
<b>Mercury® MerCruiser® Cooling System</b> . . . . .	175	<b>Gear Chart - Gear Housing</b> . . . . .	233
Hoses - Water . . . . .	179	Gear Repair Kits - Driveshaft Housing . . . . .	218
MerCruiser Thermostat Kits . . . . .	178	Gear Repair Kits - Gear Housing . . . . .	228
MerCruiser Water Pump Repair Kits - Drive . . . . .	176	Gears - Driveshaft Housing . . . . .	221
MerCruiser Water Pump Repair Kits - Sea Water . . . . .	175	Gear Sets - Driveshaft Housing . . . . .	219
Oil Coolers . . . . .	195	Gears - Gear Housing . . . . .	229
<b>Water Pump Repair Kits Chart</b> . . . . .	177	Seal & Bearing Kits - Gear Housing . . . . .	225
<b>Mercury® MerCruiser® Exhaust System</b> . . . . .	200	<b>Seal Chart - Sterndrive</b> . . . . .	226
Exhaust Water Shutters . . . . .	200	Seal Kits - Driveshaft Housing . . . . .	225
<b>Mercury® MerCruiser® External Engine</b> . . . . .	201	Seal Kits - Gear Housing . . . . .	226
Engine Couplers . . . . .	202	U-Joint and Components . . . . .	218
Serpentine Belts . . . . .	201	<b>Mercury® MerCruiser® Power Trim</b> . . . . .	235
V-Belts . . . . .	201	Power Trim Cylinder Hoses . . . . .	242
		Power Trim Pumps and Components . . . . .	235
		<b>Trim Cylinder Anchor Pin Chart</b> . . . . .	241
		Trim Cylinder Anchor Pins & Kits . . . . .	239
		<b>Trim Cylinder Chart</b> . . . . .	238
		Trim Cylinder O-Ring Kits . . . . .	237
		Trim Cylinder Repair Kits . . . . .	237

**MERCURY® MERCRUISER® IGNITION**

**TUNE UP KITS**

**TUNE-UP KIT**



**34235T 1**

Fits GM in-line 4 & 6 cylinder engines with conventional Delco ignition. See application chart for specific models.

Priced individually, sold @ multiples of 2

Mercury Branded, Clamshell Package Point of Sale Packaged.

**34235Q 1**

Fits GM in-line 4 & 6 cylinder engines with conventional Delco ignition.

Priced individually, sold @ multiples of 2

Quicksilver Branded, Clamshell Package Point of Sale Packaged.

**TUNE-UP KIT**



**392- 6324T 1**

Fits MerCruiser 3.0L, 3.7L, 3.8L (V-6), 5.7L Tow Sports and Ford 233 (V-8) with Prestolite ignition with screw down cap. See application chart for specific models.

Priced individually, sold @ multiples of 2

Mercury Branded, Clamshell Package Point of Sale Packaged.

**392- 6324Q 1**

Fits MerCruiser 3.0L, 3.7L, 3.8L (V-6), 5.7L Tow Sports and Ford 233 (V-8) with Prestolite ignition with screw down cap.

Priced individually, sold @ multiples of 2

Quicksilver Branded, Clamshell Package Point of Sale Packaged.

**TUNE-UP KIT**



**391- 5090T 1**

Fits Ford & GM V-8 engines with Mallory ignition. See application chart for specific models.

Priced individually, sold @ multiples of 2

Mercury Branded, Clamshell Package Point of Sale Packaged.

**391- 5090Q 1**

Fits Ford & GM V-8 engines with Mallory ignition.

Priced individually, sold @ multiples of 2

Quicksilver Branded, Clamshell Package Point of Sale Packaged.

**TUNE-UP KIT**



**392- 6325T 1**

Fits MerCruiser Ford 888 (s/n 3108723 and above) and Ford 233 (s/n 4173000 and above) with Prestolite ignitions with clip down cap. See application chart for specific models.

Priced individually, sold @ multiples of 2

Mercury Branded, Clamshell Package Point of Sale Packaged.

**392- 6325Q 1**

Fits MerCruiser Ford 888 (s/n 3108723 and above) and Ford 233 (s/n 4173000 and above) with Prestolite ignitions with clip down cap.

Priced individually, sold @ multiples of 2

Quicksilver Branded, Clamshell Package Point of Sale Packaged.

**POINTS**

**POINTS**

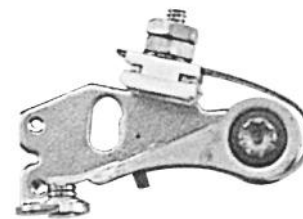

**34235T**

Fits GM 4 & 6 cyl. engines with Delco conventional ignition. See application chart for specific models.

Priced individually, sold @ multiples of 2

**34235Q**

Fits GM 4 & 6 cyl. engines with Delco conventional ignition.

Priced individually, sold @ multiples of 2

Quicksilver Branded, Clamshell Package Point of Sale Packaged.

**POINTS**



**8M6001219**

Fits Ford & GM 4, 6 & 8 cyl. Engines with Prestolite conventional ignition.

**POINTS**



**8M6001221**

Fits Ford (302 cid) with Autolite ignition. See application chart for specific models.

**POINTS**



**8M6001250**

Fits Ford & GM V-8 engines with Mallory conventional ignition.

**POINTS**



**87-71831**

Fits GM & Ford V-8 engines with Mercury ignition. See application chart for specific models.

**ROTORS**

**ROTOR**

Image not Available.

**8M6001251**

Fits GM 4 & 6 cyl. engines with Delco conventional ignition.

**ROTOR**



**58217Q**

Fits GM 4 & 6 cyl. engines with Delco conventional ignition.  
Priced individually, sold @ multiples of 2  
Quicksilver Branded, Clamshell Package Point of Sale Packaged.

**ROTOR**



**392-9089T**

Fits Ford & GM 4, 6 & 8 cyl. engines with Prestolite conventional ignition.

**392-9089Q**

Fits Ford & GM 4, 6 & 8 cyl. engines with Prestolite conventional ignition.  
Priced individually, sold @ multiples of 2  
Quicksilver Branded, Clamshell Package Point of Sale Packaged.

**ROTOR**



**8M6001254**

Use with 811635T 3 Distributor Cap  
Fits GM 4 cyl. engines with Delco EST ignition.

**ROTOR**



**13524A 6**

Fits GM V-6 engines with Thunderbolt IV & V HEI ignition. See application chart for specific models.

**13524Q06**

Fits GM V-6 engines with Thunderbolt IV & V HEI ignition. Quicksilver Branded, Clamshell Package Point of Sale Packaged.

**ROTOR**



**8M0062084**

Use with 850484T 2 Distributor Cap  
Fits GM V-6 engines with Delco HEI ignition.

**ROTOR**



**13524T 1**

Fits GM V-8 engines with Thunderbolt IV & V ignition.

**ROTOR**



**13524T12**

Fits Black Scorpion Tow Sports (s/n 0M391600 and up) and MX Black Scorpion Tow Sports (s/n 0M391750 and up)

**ROTOR**



**879288T34**

Fits Scorpion 350 & 377 Tow Sports EC engines(s/n 0W698433 and up).

**ROTOR**



**65864**

Fits Ford & GM V-8 engines with Autolite & Mercury ignition. See application chart for specific models.

**ROTOR**

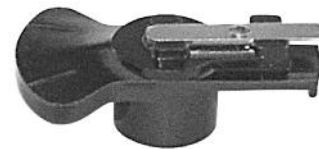

**8M6001224**

Fits Ford & GM V-8 engines with Mallory conventional ignition.

**ROTOR**



**8M6001253**

Use with 808483T 3 Distributor Cap  
Fits GM V-8 engines with Delco HEI ignition.



**ROTOR**



**8M6001252**

Use with 808483T 3 Distributor Cap  
Fits GM V-8 engines with Delco HEI ignition (1998 and newer), except MPI eng's w/ ECM 555.

**ROTOR**



**8M6001222**

Fits 2001 and newer MCM/MIE 4.3L, 5.0L, 5.7L & 6.2L MPI engines with ECM 555 (s/n 0M300000 and up).

**DISTRIBUTOR CAP AND ROTOR KITS**

**CAP AND ROTOR KIT**

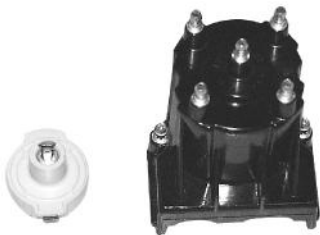

**811635K 2**

Fits GM 4 cyl. engines w/ Delco EST ignition  
Mercury Branded, Clamshell Package Point of Sale Packaged.

**811635Q 2**

Fits GM 4 cyl. engines w/ Delco EST ignition  
Quicksilver Branded, Clamshell Package Point of Sale Packaged.

**CAP AND ROTOR KIT**



**815407T 5**

Fits GM V-6 engines with Thunderbolt IV & V HEI ignitions.  
Mercury Branded, Clamshell Package Point of Sale Packaged.

**815407Q 5**

Fits GM V-6 engines with Thunderbolt IV & V HEI ignitions.  
Quicksilver Branded, Clamshell Package Point of Sale Packaged.

**CAP AND ROTOR KIT**



**850484T 3**

Fits GM V-6 engines w/ Delco HEI ignition.

**CAP AND ROTOR KIT**



**898253T28**

Fits MCM 4.3L MPI

**CAP AND ROTOR KIT**



**393- 4988T 1**

Fits Ford & GM V-8 engines w/ Autolite & Mercury ignitions

## CAP AND ROTOR KIT

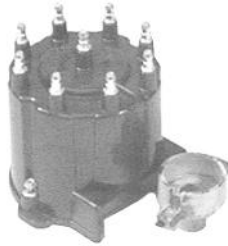

### 808483K 1

Fits 1997 & older GM V-8 engines w/ Delco HEI ignition  
Mercury Branded, Clamshell Package Point of Sale Packaged.

### 808483Q 1

Fits 1997 & older GM V-8 engines w/ Delco HEI ignition  
Quicksilver Branded, Clamshell Package Point of Sale Packaged.

## CAP AND ROTOR KIT



### 808483K 2

Fits 1998 & newer GM V-8 engines w/ Delco HEI ignition  
Mercury Branded, Clamshell Package Point of Sale Packaged.

### 808483Q 2

Fits 1998 & newer GM V-8 engines w/ Delco HEI ignition  
Quicksilver Branded, Clamshell Package Point of Sale Packaged.

## CAP AND ROTOR KIT



### 805759T 3

Fits GM V-8 engines with Thunderbolt IV & V HEI ignitions  
Mercury Branded, Clamshell Package Point of Sale Packaged.

### 805759Q 3

Fits GM V-8 engines with Thunderbolt IV & V HEI ignitions  
Quicksilver Branded, Clamshell Package Point of Sale Packaged.

## CAP AND ROTOR KIT



### 805759T05

Fits Black Scorpion Tow Sports (s/n 0M391600 and up) and MX 6.2L Black  
Scorpion Tow Sports (s/n 0M391750 and up)

## CAP AND ROTOR KIT



### 8M0061335

Fits 2001 and newer MCM/MIE 5.0L, 5.7L & 6.2L MPI engines with ECM 555 (s/n  
0M300000 and up)

## DISTRIBUTOR CAPS

### DISTRIBUTOR CAP



### 393- 9459T 1

Fits GM 4 cyl. engines with Delco conventional ignition  
Mercury Branded, Clamshell Package Point of Sale Packaged.

### 393- 9459Q 1

Fits GM 4 cyl. engines with Delco conventional ignition  
Quicksilver Branded, Clamshell Package Point of Sale Packaged.

### DISTRIBUTOR CAP



### 8M0082721

Fits GM 4 cyl. engines w/ Prestolite ignition

**DISTRIBUTOR CAP**



**811635T 3**

Fits GM 4 cyl. engines w/ Delco EST ignition

**DISTRIBUTOR CAP**



**33765T**

Fits GM in-line 6 cyl. engines w/ Delco conventional ignition.

**DISTRIBUTOR CAP**



**815407A 2**

Fits GM V-6 engines with Thunderbolt IV & V HEI ignitions

**815407Q02**

Fits GM V-6 engines with Thunderbolt IV & V HEI ignitions  
Quicksilver Branded, Clamshell Package Point of Sale Packaged.

**DISTRIBUTOR CAP**



**850484T 2**

Fits GM V-6 engines w/ Delco HEI ignition

**DISTRIBUTOR CAP**



**898253T23**

Fits MCM 4.3L MPI

**DISTRIBUTOR CAP**



**393- 4988T 2**

Fits Ford & GM V-8 engines w/ Autolite & Mercury ignitions

**DISTRIBUTOR CAP**



**391- 5075T 1**

Fits Ford & GM V-8 engines w/ Mallory ignition.  
Mercury Branded, Clamshell Package Point of Sale Packaged.

**391- 5075Q 1**

Fits Ford & GM V-8 engines w/ Mallory ignition  
Quicksilver Branded, Clamshell Package Point of Sale Packaged.

**DISTRIBUTOR CAP**



**392- 9766T 1**

Fits Ford & GM V-8 engines with Prestolite conventional ignition (screw hold-down cap)  
Mercury Branded, Clamshell Package Point of Sale Packaged.

# MERCURY® MERCRUISER® IGNITION

## 392- 9766Q 1

Fits Ford & GM V-8 engines with Prestolite conventional ignition (screw hold-down cap)  
Quicksilver Branded, Clamshell Package Point of Sale Packaged.

### DISTRIBUTOR CAP

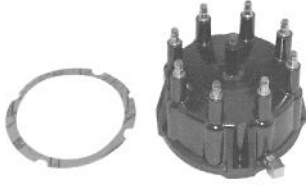

## 805759T 1

Fits GM V-8 engines with Thunderbolt IV & V HEI ignitions

## 805759Q01

Fits GM V-8 engines with Thunderbolt IV & V HEI ignitions  
Quicksilver Branded, Clamshell Package Point of Sale Packaged.

### DISTRIBUTOR CAP



## 808483T 3

Fits GM V-8 engines w/ Delco HEI ignition, except MPI engines w/ ECM 555

### DISTRIBUTOR CAP



## 8M6001106

Fits 2001 and newer MCM/MIE 5.0L, 5.7L & 6.2L MPI engines with ECM 555 (s/n 0M300000 and up)

## IGNITION KITS AND COMPONENTS CHART

### Ignition Tune-up Kits

Model	CID/ #Cyl	Type of Ignition	Year Range	Serial # Range	Tune-up Kit	Points	Rotor	Condenser	Rotor/Cap Kit	Distributor Cap
2.5L	153/ L4	Delco	1963 - 1989	1537370 - 0C853255	34235T 1	34235T	8M6001251	8M6001218	N/A	393- 9459T 1
2.5L	153/ L4	Prestolite	1963 - 1989	1537370 - 0C853255	392- 6324T 1	8M6001219	392- 9089T	8M6001249	N/A	8M0082721
3.0L	181/ L4	Delco	1968 - 1989	2508261 - 0C856558	34235T 1	34235T	8M6001251	8M6001218	N/A	393- 9459T 1
3.0L	181/ L4	Prestolite	1968 - 1991	0C856559 - 0D504541	392- 6324T 1	8M6001219	392- 9089T	8M6001249	N/A	8M0082721
3.0L	181/ L4	Delco Digital	1990 - 1991	0C856559 - 0D504541	N/A	N/A	N/A	N/A	N/A	N/A
3.0L	181/ L4	Delco EST	1991 - 2015	0D504542 and up	N/A	N/A	8M6001254	N/A	811635K 2	811635T 3
3.7L	224/ L4	Delco	1976 - 1984	4208730 and up	34235T 1	34235T	8M6001251	8M6001218	N/A	393- 9459T 1
3.7L	224/ L4	Prestolite	1976 - 1989	4208730 and up	392- 6324T 1	8M6001219	392- 9089T	8M6001249	N/A	8M0082721
3.1L	194/ L6	Delco	1963	1538930 - 1725960	34235T 1	34235T	8M6001251	8M6001218	N/A	33765T
3.8L	230/ L6	Delco	1964 - 1966	1666495 - 2048046	34235T 1	34235T	8M6001251	8M6001218	N/A	33765T
4.0L	250/ L6	Delco	1967 - 1981	2048022 - 5813433	34235T 1	34235T	8M6001251	8M6001218	N/A	33765T
4.0L	250/ L6	Prestolite	1967 - 1981	2048022 - 5813433	392- 6324T 1	8M6001219	392- 9089T	8M6001249	N/A	N.L.A.
4.8L	292/ L6	Delco	1969	2453769 - 2712072	34235T 1	34235T	8M6001251	8M6001218	N/A	33765T

# MERCURY® MERCUISER® IGNITION

MERCURY® MERCUISER®

Model	CID/ #Cyl	Type of Ignition	Year Range	Serial # Range	Tune-up Kit	Points	Rotor	Condenser	Rotor/Cap Kit	Distributor Cap
3.8L	229/ V-6	Prestolite	1983 - 1984	6330183 - 6919655	392- 6324T 1	8M6001219	392- 9089T	8M6001249	N/A	N.L.A.
4.3L	262/ V-6	Thunderbolt IV & V	1985 - 2015	6919656 and up	N/A	N/A	13524A 6	N/A	815407T 5	815407A 2
4.3L	262/ V-6	Delco - HEI	1996 - 2001	0F803800 - 0M299999	N/A	N/A	8M0062084	N/A	850484T 3	850484T 2
4.3L	262/ V-6	Delco - HEI	2002 - 2015	0M300000 and up	N/A	N/A	8M6001222	N/A	898253T28	898253T23
5.0L (Ford)	302/ V-8	Autolite	1970 - 1977	2781153 - 4887829	N.L.A.	8M6001221	65864	N.L.A.	N/A	393- 4988T 2
5.0L (Ford)	302/ V-8	Mallory	1970 - 1977	2781153 - 4887829	391- 5090T 1	8M6001250	8M6001224	8M6001217	N/A	391- 5075T 1
5.0L (Ford)	302/ V-8	Mercury	1971 - 1977	3108723 - 4887829	N.L.A.	87- 71831	65864	N.L.A.	N/A	393- 4988T 2
5.0L (Ford)	302/ V-8	Prestolite	1971 - 1977	3108723 - 4887829	392- 6325T 1	8M6001219	N.L.A.	8M6001249	N/A	N.L.A.
4.6L	283/ V-8	Delco	1963 - 1964	1564539 - 1730903	N.L.A.	N.L.A.	N.L.A.	N.L.A.	N/A	N.L.A.
5.0L	305/ V-8	Mallory	1977 - 1982	4765100 - 6218461	391- 5090T 1	8M6001250	8M6001224	8M6001217	N/A	391- 5075T 1
5.0L	305/ V-8	Thunderbolt IV & V	1981 - 2015	5907058 and up	N/A	N/A	13524T 1	N/A	805759T 3	805759T 1
5.0L	305/ V-8	Delco - HEI	1998 - 2001	0L012052 - 0M299999	N/A	N/A	8M6001253	N/A	808483K 1	808483T 3
5.0L	305/ V-8	Delco - HEI	2002 - 2015	0M300000 and up	N/A	N/A	8M6001222	N/A	8M0061335	8M6001106
5.4L	327/ V-8	Delco	1963 - 1969	1539620 - 2694014	N.L.A.	N.L.A.	N.L.A.	N.L.A.	N/A	N.L.A.
5.4L	327/ V-8	Thunderbolt	1968	2278647 - 2694014	N/A	N/A	65864	N/A	393- 4988T 1	393- 4988T 2
5.7L	350/ V-8	Thunderbolt	1969 - 1972	2851074 - 3385720	N/A	N/A	65864	N/A	393- 4988T 1	393- 4988T 2
5.7L	350/ V-8	Mercury	1975 - 1976	3258728 - 4501254	N.L.A.	87- 71831	65864	N.L.A.	N/A	393- 4988T 2
5.7L	350/ V-8	Mallory	1976 - 1995	4498701 - 0F775199	391- 5090T 1	8M6001250	8M6001224	8M6001217	N/A	391- 5075T 1
5.7L	350/ V-8	Thunderbolt IV & V	1981 - 2015	5907058 and up	N/A	N/A	13524T 1	N/A	805759T 3	805759T 1
5.7L	350/ V-8	Prestolite	1985 - 1996	0A338553 - 0F775199	392- 6324T 1	8M6001219	392- 9089T	8M6001249	N/A	392- 9766T 1
5.7L	350/ V-8	Delco - HEI	1994 - 2001	0F215561 - 0M299999	N/A	N/A	8M6001253	N/A	808483K 1	808483T 3
5.7L	350/ V-8	Delco - HEI	2002 - 2015	0M300000 and up	N/A	N/A	8M6001222	N/A	8M0061335	8M6001106
5.7L Scorpion	350/ V-8	Mercury - HEI	2003 - 2015	0M391600 and up	N/A	N/A	13524T12	N/A	805759T05	805759T 1
5.8L (Ford)	351/ V-8	Mallory	1973 - 1980	3258728 - 5907057	391- 5090T 1	8M6001250	8M6001224	8M6001217	N/A	391- 5075T 1
5.8L (Ford)	351/ V-8	Mercury	1973 - 1980	3258728 - 5907057	N.L.A.	87- 71831	65864	N.L.A.	N/A	393- 4988T 2
5.8L (Ford)	351/ V-8	Prestolite(1)	1975 - 1977	4173000 - 4902304	392- 6325T 1	8M6001219	N.L.A.	8M6001249	N/A	N.L.A.
5.8L (Ford)	351/ V-8	Prestolite(2)	1975 - 1977	4173000 - 4902304	392- 6324T 1	8M6001219	392- 9089T	8M6001249	N/A	392- 9766T 1
6.2L	377/ V-8	Thunderbolt V	2000 - 2001	0L680003 - 0M299999	N/A	N/A	13524T 1	N/A	13524T 1	805759T 1
6.2L	377/ V-8	Delco - HEI	2002 - 2015	0M300000 and up	N/A	N/A	8M6001222	N/A	8M0061335	8M6001106
6.2L Scorpion	377/ V-8	Delco - HEI	1997 - 2003	0K000656 - 0M391599	N/A	N/A	8M6001253	N/A	808483K 1	808483T 3
6.2L Scorpion	377/ V-8	Mercury - HEI	2003 - 2015	0M391600 and up	N/A	N/A	13524T12	N/A	805759T05	805759T 1
7.0L	427/ V-8	Thunderbolt	1969 - 1974	2278747 and up	N/A	N/A	65864	N/A	393- 4988T 1	393- 4988T 2
7.4L	454/ V-8	Mallory	1977 - 1986	4623115 - 0B485220	391- 5090T 1	8M6001250	8M6001224	8M6001217	N/A	391- 5075T 1
7.4L	454/ V-8	Thunderbolt	1974 - 1981	3780450 - 6083144	N/A	N/A	65864	N/A	393- 4988T 1	393- 4988T 2
7.4L	454/ V-8	Holley	1978 - 1986	4883520 - 0B485220	N.L.A.	87- 71831	65864	N.L.A.	N/A	393- 4988T 2
7.4L	454/ V-8	Thunderbolt IV & V	1981 - 1999	5889914 - 0L415623	N/A	N/A	13524T 1	N/A	805759T 3	805759T 1
7.4L	454/ V-8	Delco - HEI	1994 - 1998	0F115700 - 0L085009	N/A	N/A	8M6001253	N/A	808483K 1	808483T 3
7.4L	454/ V-8	Delco - HEI	1998 - 2001	0L085010 - 0M024999	N/A	N/A	8M6001252	N/A	808483K 2	808483T 3
7.9L	482/ V-8	Thunderbolt	1969 - 1970	2781129 - 2825059	N/A	N/A	65864	N/A	393- 4988T 1	393- 4988T 2
7.9L	482/ V-8	Mallory	1983 - 1986	6180970 - 6181046	391- 5090T 1	8M6001250	8M6001224	8M6001217	N/A	391- 5075T 1
7.9L	482/ V-8	Holley	1983 - 1986	6180970 - 6181046	N.L.A.	87- 71831	65864	N.L.A.	N/A	393- 4988T 2
8.2L	502/ V-8	Thunderbolt IV & V	1990 - 1999	0C878221 - 0L601036	N/A	N/A	13524T 1	N/A	805759T 3	805759T 1
8.2L	502/ V-8	Delco - HEI	1993 - 1998	0D840650 - 0L085000	N/A	N/A	8M6001253	N/A	808483K 1	808483T 3
8.2L	502/ V-8	Delco - HEI	1998 - 2005	0L085001 - 0M950526	N/A	N/A	8M6001252	N/A	808483K 2	808483T 3

Not all parts listed are available for the European, C.I.S., Africa and Middle East Markets.  
For more information, please contact your local Mercury, Mariner, MerCruiser or Quicksilver Office.

# MERCURY® MERCUISER® IGNITION

Model	CID/ #Cyl	Type of Ignition	Year Range	Serial # Range	Tune-up Kit	Points	Rotor	Condenser	Rotor/Cap Kit	Distributor Cap
8.8L	540/ V-8	Thunderbolt IV & V	1986 - 2001	0A677429 - 0M050281	N/A	N/A	13524T 1	N/A	805759T 3	805759T 1

(1) With clip down distributor cap

(2) With screw down distributor cap

**MERCURY® MERCUISER® ELECTRICAL SYSTEM**

**STARTER SLAVE SOLENOIDS**

**SOLENOID**



**25661T 1**

**SOLENOID**



**65057T 1**

**SOLENOID**



**89- 76416A 1**

Grounded Base

**SOLENOID**



**89- 96054T**

Flat mounting plate  
Fits In-Line 6 Outboards & MerCruiser engines

**SOLENOID**



**89- 96158T**

Stepped mounting plate  
Fits Outboard Starters & MerCruiser Starters and Pwr Trim.

**SOLENOID**



**89-818999A 2**

**SOLENOID**



**89-850188T 1**

Fits Outboard 6 - 25 Hp and 50 - 60 Hp 3 Cyl. & MCM applications

**SOLENOID**



**89-850187T 1**

## SOLENOID



**89-853654A 1**

Fits Outboard 2 Cyl. & In-Line 6 & MCM applications

## RELAY



**86-865202T**

## RELAY



**882751**

## POWER TRIM RELAY



**882751A 1**

## RELAY



**882751A04**

Used on 200/225/250/275 Verado outboards beginning with Model Year 2005. Also used on MCM 496 & MIE 8.1L.

## ELECTRICAL HARNESS REPAIR KITS

### MOLEX REPAIR KIT, 14-PIN, FEMALE

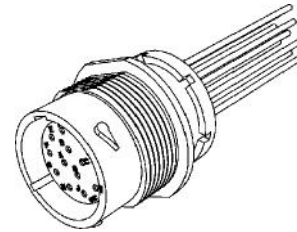

**84-8M0062009**

Use when the replacement of the entire harness is not necessary. Includes the Molex 14-pin female connector and 14 crimp splices.

Fits all MCM & O/B engines with the 14 pin Molex engine harness

### MOLEX REPAIR KIT, 14-PIN, MALE

Image not Available.

**8M0096940**

Use when the replacement of the entire harness is not necessary. Includes the Molex 14-pin male connector and 14 crimp splices.

Fits all MCM & O/B engines with the 14 pin Molex engine harness

### TMAP TEMPERATURE AND MANIFOLD AIR PRESSURE REPAIR KIT, 4-PIN, FEMALE

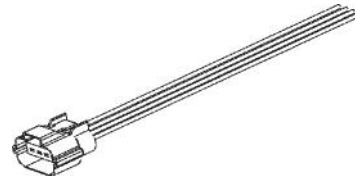

**84-8M0062010**

Use when the replacement of the entire harness is not necessary. Includes the TMAP 4-pin female connector and 4 crimp splices.

Fits MCM 3.0L MPI EC engines TMAP sensor

### O2 SENSOR REPAIR KIT, 4-PIN, MALE

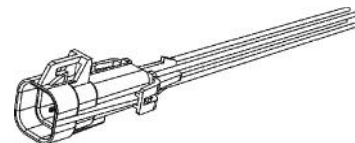

**84-8M0062011**

Use when the replacement of the entire harness is not necessary. Includes the O2 sensor 4-pin male connector and 4 crimp splices.

Fits MCM EC engines O2 sensor



**CPS CRANK POSITION SENSOR REPAIR KIT, 3-PIN, FEMALE**

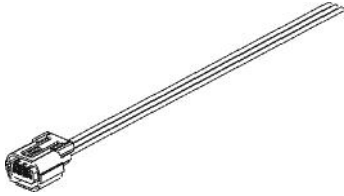

**84-8M0062012**

Use when the replacement of the entire harness is not necessary. Includes the Crank Position 3-pin female connector and 3 crimp splices.  
Fits MCM V-6 engines with CPS

**MAT MANIFOLD AIR TEMPERATURE REPAIR KIT, 2-PIN, FEMALE**

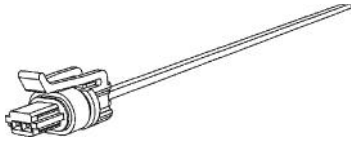

**84-8M0062013**

Use when the replacement of the entire harness is not necessary. Includes the MAT 2-pin female connector and 2 crimp splices.  
Fits MCM 8.2L engines MAT sensor

**PACKARD REPAIR KIT, 2-PIN, MALE**

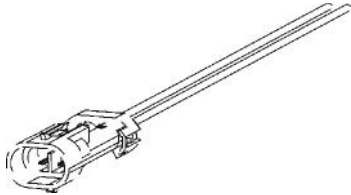

**84-8M0062014**

Use when the replacement of the entire harness is not necessary. Includes the Packard 2-pin male connector and 2 crimp splices.  
Fits MCM engines with Packard 2-pin connector for clean power

**PACKARD REPAIR KIT, 6-PIN, FEMALE**

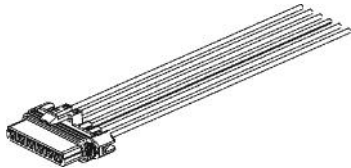

**84-8M0062015**

Use when the replacement of the entire harness is not necessary. Includes the Packard 6-pin female connector and 6 crimp splices.  
Fits MCM 3.0L MPI engines with Packard 6-pin connector for engine O2 sensor mini fuses

**PACKARD REPAIR KIT, 8-PIN, FEMALE**

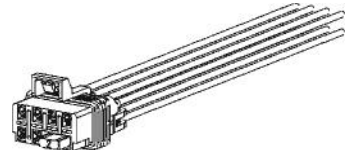

**84-8M0062016**

Use when the replacement of the entire harness is not necessary. Includes the Packard 8-pin female connector and 8 crimp splices.  
Fits MCM engines with Packard 8-pin connector for engine mini fuses

**PACKARD REPAIR KIT, 2-PIN, FEMALE**

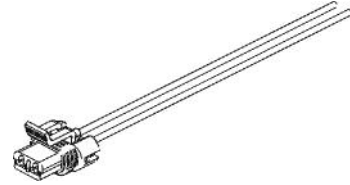

**84-8M0062017**

Use when the replacement of the entire harness is not necessary. Includes the Packard 2-pin female connector and 2 crimp splices.  
Fits MCM engines with Packard 2-pin connector for fuel pump, 2 amp OBDM fuse and shift switch

**PACKARD REPAIR KIT, 3-PIN, MALE**

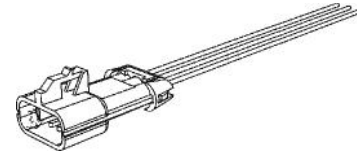

**84-8M0062018**

Use when the replacement of the entire harness is not necessary. Includes the Packard 3-pin male connector and 3 crimp splices.  
Fits MCM engines with Packard 3-pin connector for shift interrupt and neutral safety switch

**FUEL INJECTOR REPAIR KIT, 2-PIN, FEMALE**

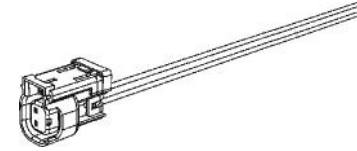

**84-8M0062019**

Use when the replacement of the entire harness is not necessary. Includes the fuel injector 2-pin female connector and 2 crimp splices.  
Fits MCM 4.3L, 5.0L, 5.7L and 6.2L MPI engines fuel injector

**PACKARD REPAIR KIT, 3-PIN, FEMALE**

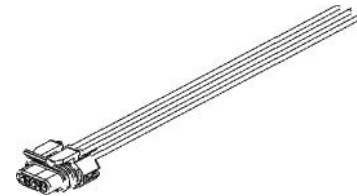

**84-8M0062020**

Use when the replacement of the entire harness is not necessary. Includes the Packard 3-pin female connector and 3 crimp splices.  
Fits MCM 4.3L, 5.0L, 5.7L and 6.2L MPI engines ignition coil

**CPS CRANK POSITION SENSOR REPAIR KIT, 3-PIN, FEMALE**

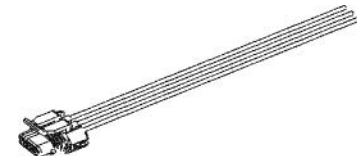

**84-8M0062021**

Use when the replacement of the entire harness is not necessary. Includes the Crank Position 3-pin female connector and 3 crimp splices.  
Fits MCM V-8 engines with CPS

## TMAP TEMPERATURE AND MANIFOLD AIR PRESSURE REPAIR KIT, 4-PIN, FEMALE

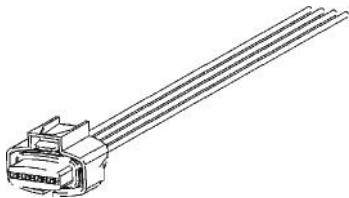

### 84-8M0062022

Use when the replacement of the entire harness is not necessary. Includes the TMAP 4-pin female connector and 4 crimp splices.

Fits MCM 4.3L, 5.0L, 5.7L and 6.2L MPI engines TMAP sensor

## TRANSOM HARNESS REPAIR KIT, 16-PIN, MALE

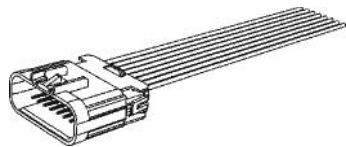

### 84-8M0062023

Use when the replacement of the entire harness is not necessary. Includes the Transom harness 16-pin male connector and 16 crimp splices.

Fits MCM MPI engines with harness connector

## OIL PRESSURE SWITCH REPAIR KIT, 3-PIN, FEMALE

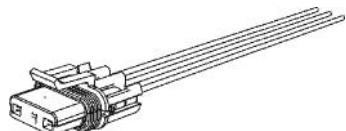

### 84-8M0062024

Use when the replacement of the entire harness is not necessary. Includes the Oil Pressure Switch harness 3-pin female connector and 3 crimp splices.

Fits MCM 3.0L TKS engines oil pressure switch

## CAN 1/P & H RESISTOR REPAIR KIT, 10-PIN, MALE

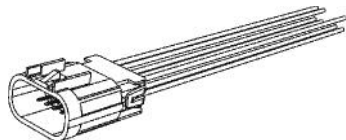

### 84-8M0062025

Use when the replacement of the entire harness is not necessary. Includes the 10 pin Can 1/P & H Resistor harness connector w/7 male pins and 7 crimp splices.

Fits MCM 8.2L DTS engines Can 1/P & H resistor

## IAC IDLE AIR CONTROL REPAIR KIT, 2-PIN, FEMALE

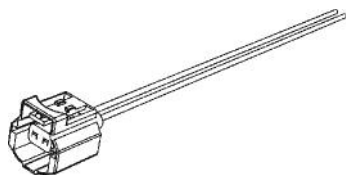

### 84-8M0062026

Use when the replacement of the entire harness is not necessary. Includes the Idle Air Control harness 2-pin female connector and 2 crimp splices.

Fits MCM MPI engines with mechanical throttle body

## COIL PORT REPAIR KIT, 4-PIN, FEMALE

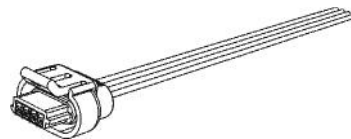

### 84-8M0062027

Use when the replacement of the entire harness is not necessary. Includes the Coil Port harness 2-pin female connector and 2 crimp splices.

Fits MCM 8.2L engines with mechanical throttle body

MERCURY® MERCUISER® FUEL SYSTEM

**CARBURETOR REPAIR KITS**

**CARBURETOR REPAIR KIT**



**1397- 5831**

For Rochester 2bbl. See application chart for specific models.

**CARBURETOR REPAIR KIT**



**1397- 6367A 1**

For Rochester 2bbl. See application chart for specific models.

**CARBURETOR REPAIR KIT**



**1397- 8760**

For Rochester 2bbl. See application chart for specific models.

**CARBURETOR REPAIR KIT**



**823427A 1**

For Rochester 2bbl.  
Fits 1964-1983 MCM GM 4 & 6 cyl. Engines

**CARBURETOR REPAIR KIT**



**3302-804845**

Fits 1983-1986 MCM 120, 140, 470, 185, 200 & 898 engines with the older MerCarb 2 bbl. having the bottom fill accelerator pump cavity.

**CARBURETOR REPAIR KIT**



**3302-804844002**

Fits 1986 & newer MCM 4 cyl, V-6 & V-8 (305 & 350 cid) engines with the newer MerCarb 2bbl. having the current side fill accelerator pump cavity.

**CARBURETOR REPAIR KIT**



**1396- 4656**

Contains Adjustable Needles & Seats  
For Holley 2bbl. See application chart for specific models.

**CARBURETOR REPAIR KIT**

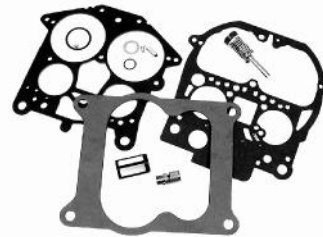

**823426A 1**

For Rochester 4bbl. QuadraJet.  
Fits 1969-1995 MCM 4 & 6 cyl. in-line, V-6 & V-8 (305, 350, 427, 454 & 502 cid) engines

## CARBURETOR REPAIR KIT



**809064**

For Weber 4bbl.  
Fits 1987-1997 MCM/MIE/Tow Sports 350 Mag & 5.7L/LX engines with 9665 & 9781 Weber carbs. Also fits 1990-1997 MCM/MIE 454 Mag, 502 Mag, 7.4L & 8.2L engines.

## CARBURETOR REPAIR KIT



**809065**

For Weber 4bbl.  
Fits 1987-1996 MCM/MIE/Tow Sports 350 Mag & 5.7L engines with 9661 & 9770 Weber carbs

## CARBURETOR REPAIR KIT



**823728**

For Weber 4bbl.  
Fits 1992-1996 MCM 4.3LX (s/n 0D714370-0F802999)

## CARBURETOR REPAIR KIT



**835076**

For Weber 4bbl.  
Fits 1996-2002 MCM 4.3LH & LXH (s/n 0F803114-0M614999)

## CARBURETOR REPAIR KIT

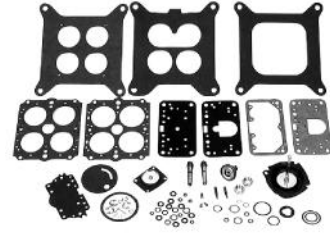

**1396- 5238**

Contains Adjustable Needles & Seats  
For Holley 4bbl. See application chart for specific models.

## CARBURETOR REPAIR KIT



**13220**

For Holley 4bbl. See application chart for specific models.

## CARBURETOR REPAIR KIT



**8M0050786**

For Holley 4bbl. See application chart for specific models.

## CARBURETOR GASKET KITS

### CARBURETOR GASKET KIT



**3310-810929004**

For MerCarb 2bbl.

**MERCURISER FUEL FILTERS - CARBURETOR**

**CARBURETOR FUEL FILTER**



**1397- 8767T**

For Rochester 2bbl. & 4bbl.  
Priced individually, sold @ multiples of 2  
Mercury Branded, Clamshell Package Point of Sale Packaged.

**1397- 8767Q**

For Rochester 2bbl. & 4bbl.  
Priced individually, sold @ multiples of 2  
Quicksilver Branded, Clamshell Package Point of Sale Packaged.

**CARBURETOR FUEL FILTER**



**35- 53336T**

For Rochester 2 & 4-barrel and MerCarb 2-barrel carburetors.  
Priced individually, sold @ multiples of 2  
Mercury Branded, Clamshell Package Point of Sale Packaged.

**35- 53336Q**

For Rochester 2 & 4-barrel and MerCarb 2-barrel carburetors.  
Priced individually, sold @ multiples of 2  
Quicksilver Branded, Clamshell Package Point of Sale Packaged.

**CARBURETOR FUEL FILTER**



**35- 93568**

For Holley 4bbl.

**CARBURETOR AND REPAIR PARTS CHART**

**Carburetors**

Model	CID/ # Cyl.	Year Range	Serial # Range	Original Carb P/N	Original Mfg. P/N Code / Model	Carb Repair Kit	Needle & Seat	Accel Pump	Replacement Carb
60	68/ L4	1965 - 1968	1887079 - 2049044	1342- 2565	MD135A	N.L.A.	N.L.A.	N.L.A.	N.L.A.
60	68/ L4	1965 - 1968	1887079 - 2049044	1342- 2564	MD134A	N.L.A.	N.L.A.	N.L.A.	N.L.A.
80	80/ L4	1966 - 1969	2049045 - 2851423	1346- 2770	RBS4394S C1/RBS	N.L.A.	N.L.A.	N.L.A.	N.L.A.
90	96/ L4	1970 - 1971	2851424 - 3225967	1351- 4263A 1	7040082 R2/2GC	823427A 1	N.S.S.	N.S.S.	N.L.A.
90	96/ L4	1972	3225868 - 3226957	1351- 4263A 2	7041369 R2/2GC	823427A 1	N.S.S.	N.S.S.	N.L.A.
110	153/ L4	1963 - 1966	1537370 - 2044033	1336- 2076	7036543 R2/2GC	N.L.A.	N.S.S.	N.S.S.	N.L.A.
120	153/ L4	1964 - 1968	1666601 - 2520424	1336- 2076	7036543 R2/2GC	N.L.A.	N.S.S.	N.S.S.	N.L.A.
120	153/ L4	1969 - 1972	2520425 - 3377340	1336- 3594A 1	7036543 R2/2GC	N.L.A.	N.S.S.	N.S.S.	N.L.A.
120	153/ L4	1972 - 1973	3377341 - 3770649	1351- 4263A 3	7041369 R2/2GC	823427A 1	N.S.S.	N.S.S.	N.L.A.
120	153/ L4	1974 - 1975	3770650 - 4469865	1351- 5202A 1	7043182 R2/2GC	823427A 1	N.S.S.	N.S.S.	N.L.A.
120	153/ L4	1976 - 1978	4469866 - 5192048	1351- 6065A 2	7044182 R2/2GC	823427A 1	N.S.S.	N.S.S.	N.L.A.
120	153/ L4	1979 - 1982	5192049 - 6229717	1351- 7354A 1	17059054 R2/2GC	823427A 1	N.S.S.	N.S.S.	N.L.A.

Not all parts listed are available for the European, C.I.S., Africa and Middle East Markets.  
For more information, please contact your local Mercury, Mariner, MerCruiser or Quicksilver Office.

# MERCURY® MERCUISER® FUEL SYSTEM

Model	CID/ # Cyl.	Year Range	Serial # Range	Original Carb P/N	Original Mfg. P/N Code / Model	Carb Repair Kit	Needle & Seat	Accel Pump	Replacement Carb
120	153/ L4	1983	6229718 - 6663797	1351- 8480A 2	17081060 R2/2GC	823427A 1	N.S.S.	1397- 8880	N.L.A.
120	153/ L4	1984	6663798 - 6853913	1389- 8490A 2	M2/MERCARB	3302-804845	3302- 9407	3302- 9046	3310-860070A 2
120	153/ L4	1985	6853914 - 0A492055	1389- 9350A 2	M2/MERCARB	3302-804845	3302- 9407	3302- 9046	3310-860070A 2
120	153/ L4	1986	0A492056 - 0B531853	1389- 9562A 1	M2/MERCARB	3302-804844002	3302- 9407	3302- 9655 1	3310-860070A 2
2.5L	153/ L4	1987 - 1989	0B531854 - 0C853255	3310-806077A 2	M2/MERCARB	3302-804844002	3302- 9407	3302- 9655 1	3310-860070A 2
140	181/ L4	1968 - 1969	2508261 - 2816416	1351- 3635A 1	7036646 R/2GC	823427A 1	N.S.S.	N.S.S.	N.L.A.
140	181/ L4	1970	2816417 - 2911439	1351- 4032A 1	7040080 R/2GC	823427A 1	N.S.S.	N.S.S.	N.L.A.
140	181/ L4	1970 - 1973	2911440 - 3771644	1351- 4293A 1	7040084 R/2GC	823427A 1	N.S.S.	N.S.S.	N.L.A.
140	181/ L4	1974 - 1978	3771645 - 5157668	1351- 5203A 1	7043184 R/2GC	823427A 1	N.S.S.	N.S.S.	N.L.A.
140	181/ L4	1979 - 1982	5157669 - 6229717	1351- 7355A 1	17059052 R/2GC	823427A 1	N.S.S.	N.S.S.	N.L.A.
140	181/ L4	1983	6229718 - 6671328	1351- 8480A 2	17081060 R/2GC	823427A 1	N.S.S.	1397- 8880	N.L.A.
140	181/ L4	1984	6671329 - 6852269	1389- 8490A 2	M2/MERCARB	3302-804845	3302- 9407	3302- 9046	3310-860070A 2
140	181/ L4	1985	6852270 - 0A484072	1389- 9350A 2	M2/MERCARB	3302-804845	3302- 9407	3302- 9046	3310-860070A 2
140	181/ L4	1986	0A484073 - 0B450800	1389- 9562A 1	M2/MERCARB	3302-804844002	3302- 9407	3302- 9655 1	3310-860070A 2
3.0L	181/ L4	1987 - 1989	0B450801 - 0C856556	3310-806077A 2	M2/MERCARB	3302-804844002	3302- 9407	3302- 9655 1	3310-860070A 2
3.0L	181/ L4	1990	0C856557 - 0D447414	1389-815396A 2	M2/MERCARB	3302-804844002	3302-804689	3302- 9655 1	3310-860070A 2
3.0L	181/ L4	1991 - 1993	0D447415 - 0D836075	1389-806077A 2	M2/MERCARB	3302-804844002	3302-804689	3302- 9655 1	3310-860070A 2
3.0L	181/ L4	1993 - 1994	0D836076 - 0F603999	1389-806078A 2	M2/MERCARB	3302-804844002	3302-804689	3302- 9655 1	3310-860070A 2
3.0L	181/ L4	1998 - 2002	0L010042 - 0M385672	3310-807504A 1	M2/MERCARB	3302-804844002	3302-804689	3302- 9655 1	3310-8M0045397
3.0L	181/ L4	2003 - 2004	0M385673 - 0W301999	3310-864940A01	M2/MERCARB	3302-804844002	3302-804689	3302- 9655 1	3310-8M0045397
3.0L	181/ L4	2004 - 2015	0W302000 and up	3310-866140A02	M2/MERCARB/TKS	3302-804844002	3302-804689	3302- 9655 1	3310-8M0084193
3.0LX	181/ L4	1990 - 1997	0C856559 - 0K999999	1389-815397A 2	M2/MERCARB	3302-804844002	3302-804689	3302- 9655 1	3310-8M0045397
3.0LX	181/ L4	1990 - 1997	0C856559 - 0K999999	3310-805924A 2	M2/MERCARB	3302-804844002	3302-804689	3302- 9655 1	3310-8M0045397
165 (4 cyl.)	224/ L4	1987	0B434941 - 0B774251	1389- 9564A 1	M2/MERCARB	3302-804844002	3302- 9407	3302- 9655 1	3310-860071A 2
170	224/ L4	1985 - 1989	6916779 - 0B434940	1389- 9564A 1	M2/MERCARB	3302-804844002	3302- 9407	3302- 9655 1	3310-860071A 2
180	224/ L4	1987	0B436391 - 0B775248	1347- 9142A 2	17083522 R4/4ME	823426A 1	1397- 8548	1397- 9669	N.L.A.
190 (4 cyl.)	224/ L4	1985 - 1986	6916779 - 0B436390	1347- 9142A 2	17083522 R4/4ME	823426A 1	1397- 8548	1397- 9669	N.L.A.
3.7L	224/ L4	1988 - 1989	0B774252 and up	1389- 9564A 1	M2/MERCARB	3302-804844002	3302- 9407	3302- 9655 1	3310-860071A 2
3.7LX	224/ L4	1988 - 1989	0B775249 and up	1347- 9142A 2	17083522 R4/4ME	823426A 1	1397- 8548	1397- 9669	N.L.A.
470	224/ L4	1976 - 1984	4208730 - 6916778	1376- 5990A 1	17057132 R2/2GC	1397- 6367A 1	N.S.S.	N.S.S.	3310-860071A 4(10 )
470	224/ L4	1983 - 1984	6218037 - 6916778	1389- 8489A 5	M2/MERCARB	3302-804845	3302-804689	3302- 9046	3310-860071A 2(9)
485	224/ L4	1980 - 1982	5685394 - 6218036	1376- 5990A 1	17057132 R2/2GC	1397- 6367A 1	N.S.S.	N.S.S.	3310-860071A 4
488	224/ L4	1983 - 1984	6170297 - 6916778	1347- 8460A 3	17081299 R4/4ME	823426A 1	N.L.A.	1397- 9669	N.L.A.
140 (6 cyl.)	194/ L6	1963	1538930 - 1725960	1338- 2161	7025638 R1/BC	N.L.A.	N.S.S.	N.S.S.	N.L.A.
140 (6 cyl.)	194/ L6	1963	1538930 - 1725960	1338- 2166	7025662 R1/B	N.L.A.	N.S.S.	N.S.S.	N.L.A.
150	230/ L6	1964 - 1966	1666495 - 1823489	1338- 2428	7024180 R1/BC	N.L.A.	N.S.S.	N.S.S.	N.L.A.
150	230/ L6	1964 - 1966	1666495 - 1823489	1338- 2431	7024181 R1/B	N.L.A.	N.S.S.	N.S.S.	N.L.A.
150	230/ L6	1964 - 1966	1823490 - 1830151	1338- 2608	7025183 R1/BC	N.L.A.	N.S.S.	N.S.S.	N.L.A.
150	230/ L6	1964 - 1966	1823490 - 1830151	1338- 2609	7025184 R1/B	N.L.A.	N.S.S.	N.S.S.	N.L.A.
150	230/ L6	1964 - 1966	1830152 - 2048046	1338- 2633	7025188 R2/2GC	823427A 1	N.S.S.	N.S.S.	N.L.A.
160	250/ L6	1967 - 1968	2048022 - 2492035	1338- 2991	7026088 R2/2GC	823427A 1	N.S.S.	N.S.S.	N.L.A.
160	250/ L6	1969	2492036 - 2770031	1351- 3635A 1	7036646 R2/2GC	823427A 1	N.S.S.	N.S.S.	N.L.A.
165 (6 cyl.)	250/ L6	1970 - 1972	2770032 - 3354791	1351- 4282A 1	7040083 R2/2GC	823427A 1	N.S.S.	N.S.S.	N.L.A.
165 (6 cyl.)	250/ L6	1972 - 1973	3354702 - 3774864	1351- 4871A 1	7042183 R2/2GC	823427A 1	N.S.S.	N.S.S.	N.L.A.
165 (6 cyl.)	250/ L6	1974 - 1978	3774865 - 5178958	1351- 5204A 1	7043183 R2/2GC	823427A 1	N.S.S.	N.S.S.	N.L.A.
165 (6 cyl.)	250/ L6	1979 - 1981	5178959 - 5813433	1351- 7356A 1	17059050 R2/2GC	823427A 1	N.S.S.	N.S.S.	N.L.A.
200 (6 cyl.)	292/ L6	1969	2453769 - 2494935	1347- 3237A 2	7037082 R4/4MV	823426A 1	N.L.A.	N.L.A.	N.L.A.
200 (6 cyl.)	292/ L6	1969	2494936 - 2712072	1347- 3237A 4	7037082 R4/4MV	823426A 1	N.L.A.	N.L.A.	N.L.A.

MERCURY® MERCUISER®

# MERCURY® MERCUISER® FUEL SYSTEM

MERCURY® MERCUISER®

Model	CID/ # Cyl.	Year Range	Serial # Range	Original Carb P/N	Original Mfg. P/N Code / Model	Carb Repair Kit	Needle & Seat	Accel Pump	Replacement Carb
185 (4 bbl.)	229/ V-6	1993 - 1994	6330183 - 6919655	3300- 8886A 2	17083515 R4/4ME	823426A 1	1397- 8548	1397- 9669	N.L.A.
175	262/ V-6	1987	0B527955 - 0B773242	3304- 9565A 1	M2/MERCarb	3302-804844002	3302- 9407	3302- 9655 1	3310-807764A 1
185	262/ V-6	1985 - 1986	0A331455 - 0B527954	3304- 9353A 2	M2/MERCarb	3302-804845	3302- 9407	3302- 9046	3310-807764A 1
205	262/ V-6	1985 - 1987	0A331455 - 0B775129	3304- 9354A 2	17084516 R4/4MV	823426A 1	1397- 8548	1397- 9669	N.L.A.
4.3L	262/ V-6	1988 - 1992	0B773243 - 0D714106	3304- 9565A 1	M2/MERCarb	3302-804844002	3302- 9407	3302- 9655 1	3310-807764A 1
4.3L	262/ V-6	1992 - 1993	0D714107 - 0F000877	3304- 9565A 7	M2/MERCarb	3302-804844002	3302- 9407	3302- 9655 1	3310-807764A 1
4.3L	262/ V-6	1993 - 1995	0F000878 - 0F601126	3310-806080A 2	M2/MERCarb	3302-804844002	3302-804689	3302- 9655 1	3310-807764A 1
4.3L	262/ V-6	1993 - 1995	0F000878 - 0F601126	3310-806972A 1	M2/MERCarb	3302-804844002	3302-804689	3302- 9655 1	3310-807764A 1
4.3L	262/ V-6	1996 - 2002	0F601127 - 0M614999	3310-807764A 1	M2/MERCarb	3302-804844002	3302-804689	3302- 9655 1	3310-807764A 1
4.3L	262/ V-6	2002 - 2004	0M615000 - 0W300012	3310-864941A01	M2/MERCarb	3302-804844002	3302-804689	3302- 9655 1	N.L.A.
4.3L	262/ V-6	2000 - 2004	0L619000 - 0W300012	3310-864941A01	M2/MERCarb	3302-804844002	3302-804689	3302- 9655 1	865960A02(17)
4.3L	262/ V-6	2004 - 2015	0W300013 and up	3310-866141A02	M2/MERCarb/TKS	3302-804844002	3302-804689	3302- 9655 1	3310-8M0084194
4.3LH	262/ V-6	1998 - 2002	0L010044 - 0M614999	3310-807826A 1	9666 WEBER	835076	823727	811537	N.L.A.
4.3LX	262/ V-6	1988 - 1991	0B775130 - 0D714369	3304- 9354A 2	17084516 R4/4MV	823426A 1	1397- 8548	1397- 9669	N.L.A.
4.3LX	262/ V-6	1992 - 1996	0D714370 - 0F802999	3310-818660A 1	9600 WEBER	823728	823727	811537	N.L.A.
4.3LXH	262/ V-6	1996 - 1997	0F803114 - 0K999999	3310-807826A 1	9666 WEBER	835076	823727	811537	N.L.A.
215 MCM / MIE (Ford)	302/ V-8	1970 - 1972	2781153 - 3385720	1356- 4066	C9FF9510E H4/4160	1396- 5238	N.L.A.	N.L.A.	N.L.A.
225 MCM / MIE (Ford)	302/ V-8	1973 - 1974	3385721 - 4166999	1356- 5155	D2JL9510C H4/4160	1396- 5238	N.L.A.	N.L.A.	N.L.A.
888 (Ford)	302/ V-8	1971 - 1977	3108723 - 4887829	1356- 4642	D1JU95108 H2/2300	1396- 4656	N.L.A.	N.L.A.	N.L.A.
888 (Ford)	302/ V-8	1971 - 1977	3108723 - 4887829	1376- 5659A 1	7044185 R2/2GC	1397- 5831	N.S.S.	N.S.S.	N.L.A.(10)
190	283/ V-8	1963 - 1964	1564539 - 1730903	1339- 2249	7026358 R2/2GC	N.L.A.	N.S.S.	N.S.S.	N.L.A.
198 MIE	305/ V-8	1977	4776402 - 4931099	1376- 6491A 1	17057139 R2/2GC	1397- 5831	N.S.S.	N.S.S.	3310-861080A 1
200	305/ V-8	1985 - 1986	6899058 - 0A482026	1389- 8488A 2	M2/MERCarb	3302-804845	3302- 9407	3302- 9046	3310-861080A 1
200	305/ V-8	1986 - 1987	0A482027 - 0B525981	1389- 9563A 1	M2/MERCarb	3302-804844002	3302- 9407	3302- 9655 1	3310-861080A 1
200	305/ V-8	1987	0B525982 - 0B774444	1389- 9670A 2	M2/MERCarb	3302-804844002	3302-804689	3302- 9655 1	3310-807312A 1
228	305/ V-8	1977 - 1978	4765100 - 5069430	1347- 6427A 1	17057282 R4/4MV	823426A 1	N.S.S.	N.S.S.	9661A 3
228	305/ V-8	1978 - 1981	5069431 - 6021783	1347- 7361A 1	17059292 R4/4MV	823426A 1	N.S.S.	N.S.S.	9661A 3
228	305/ V-8	1982	6021784 - 6218461	1347- 8296A 4	17080565 R4/4MV	823426A 1	1397- 8548	1397- 9669	9661A 3
228	305/ V-8	1982 - 1984	6218462 - 6899268	1347- 9661A 3	17080565 R4/4MV	823426A 1	1397- 8548	1397- 9669	9661A 3
228 MIE	305/ V-8	1977 - 1978	4765100 - 5069430	1347- 6438A 1	17057283 R4/4MV	823426A 1	N.S.S.	N.S.S.	9661A 3
228 MIE	305/ V-8	1978 - 1982	5069431 - 6040745	1347- 7364A 1	17059291 R4/4MV	823426A 1	N.S.S.	N.S.S.	9661A 3
228 TR	305/ V-8	1977 - 1978	4765100 - 5069430	1347- 6438A 1	17057283 R4/4MV	823426A 1	N.S.S.	N.S.S.	9661A 3
230	305/ V-8	1985 - 1987	6899269 - 0B773739	1347- 9661A 3	17080565 R4/4MV	823426A 1	1397- 8548	1397- 9669	9661A 3
230 MIE	305/ V-8	1982 - 1987	6040746 - 0B788151	1347- 8290A 1	17080564 R4/4MV	823426A 1	1397- 8548	1397- 9669	9661A 3
5.0L	305/ V-8	1988 - 1995	0B774445 - 0F600999	1389- 9670A 2	M2/MERCarb	3302-804844002	3302-804689	3302- 9655 1	3310-807312A 1
5.0L (Gen +)	305/ V-8	1998 - 2002	0L015751 - 0M599999	3310-861448A 1	M2/MERCarb	3302-804844002	3302-804689	3302- 9655 1	3310-864942A01
5.0L (Gen +)	305/ V-8	2002 - 2004	0M600000 - 0W300009	3310-864942A01	M2/MERCarb	3302-804844002	3302-804689	3302- 9655 1	3310-864942A01
5.0L (Gen +)	305/ V-8	2000 - 2004	0L619000 - 0W300009	3310-864942A01	M2/MERCarb	3302-804844002	3302-804689	3302- 9655 1	865961A02(17)
5.0L (Gen +)	305/ V-8	2004 - 2015	0W300010 and up	3310-866142A03	M2/MERCarb/TKS	3302-804844002	3302-804689	3302- 9655 1	3310-866142A04
5.0LX	305/ V-8	1988 - 1995	0B773740 - 0F600999	1347- 9661A 3	17080565 R4/4MV	823426A 1	1397- 8548	1397- 9669	9661A 3
898	305/ V-8	1977	4762210 - 6021383	1376- 6491A 1	17057139 R2/2GC	1397- 5831	N.S.S.	N.S.S.	3310-861080A 1
898	305/ V-8	1982	6021384 - 6218461	1376- 8295A 3	17080350 R2/2GC	1397- 8760	N.S.S.	N.S.S.	3310-861080A 1
898	305/ V-8	1983 - 1984	6218462 - 6899057	1389- 8488A 2	M2/MERCarb	3302-804845	3302- 9407	3302- 9046	3310-861080A 1
225 MCM / MIE (GM)	327/ V-8	1963 - 1969	1539620 - 2694014	1337- 2103(1)	7025564 R4/4GC	N.L.A.	N.S.S.	N.S.S.	N.L.A.
225 MCM / MIE (GM)	327/ V-8	1963 - 1969	1539620 - 2694014	1337- 2604(1)	7025756 R4/4GC	N.L.A.	N.S.S.	N.S.S.	N.L.A.
225 MCM / MIE (GM)	327/ V-8	1963 - 1969	1539620 - 2694014	1347- 3353(1)	7037082 R4/4MV	N.L.A.	N.S.S.	N.S.S.	N.L.A.
225 MCM / MIE (GM)	327/ V-8	1963 - 1969	1539620 - 2694014	1347- 3237A 3(4)	7037082 R4/4MV	N.L.A.	N.S.S.	N.S.S.	N.L.A.
250	350/ V-8	1977	4768000 - 4908849	1347- 3353(1)	7037082 R4/4MV	N.L.A.	N.S.S.	N.S.S.	N.L.A.
250	350/ V-8	1977	4768000 - 4908849	1347- 3237A 3(4)	7037082 R4/4MV	N.L.A.	N.S.S.	N.S.S.	N.L.A.
255	350/ V-8	1975 - 1976	4175500 - 4767999	1347- 5732A 1	7044291 R4/4MV	823426A 1	N.S.S.	N.S.S.	N.L.A.

Not all parts listed are available for the European, C.I.S., Africa and Middle East Markets.  
 For more information, please contact your local Mercury, Mariner, MerCruiser or  
 Quicksilver Office.

# MERCURY® MERCUISER® FUEL SYSTEM

Model	CID/ # Cyl.	Year Range	Serial # Range	Original Carb P/N	Original Mfg. P/N Code / Model	Carb Repair Kit	Needle & Seat	Accel Pump	Replacement Carb
255 MIE (GM)	350/ V-8	1975 - 1978	4175500 - 4924564	1347- 5732A 1	7044291 R4/4MV	823426A 1	N.S.S.	N.S.S.	N.L.A.
255 MIE (GM)	350/ V-8	1978	4924565 - 5195908	1347- 7062A 1	17057295 R4/4MV	823426A 1	N.S.S.	N.S.S.	N.L.A.
255 MIE (GM)	350/ V-8	1979 - 1980	5195909 - 5907057	1347- 7365A 1	17059289 R4/4MV	823426A 1	N.S.S.	N.S.S.	N.L.A.
260	350/ V-8	1978	4908850 - 5060805	1347- 6492A 1	17057298 R4/4MV	823426A 1	N.S.S.	N.S.S.	N.L.A.
260	350/ V-8	1978 - 1982	5060806 - 6024393	1347- 7362A 1	17059288 R4/4MV	823426A 1	N.S.S.	N.S.S.	N.L.A.
260	350/ V-8	1982 - 1987	6024393 - 0B525981	1347- 8292A 4	17080561 R4/4MV	823426A 1	1397- 8548	1397- 9669	N.L.A.
260	350/ V-8	1987	0B525982 - 0B773304	1347- 9662A 4	17080561 R4/4MV	823426A 1	1397- 8548	1397- 9669	N.L.A.
260 MIE	350/ V-8	1981 - 1987	5907058 - 0B522505	1347- 8289A 1	17080562 R4/4MV	823426A 1	1397- 8548	1397- 9669	N.L.A.
260 MIE	350/ V-8	1987	0B522506 - 0B788151	1347- 9662A 4	17080561 R4/4MV	823426A 1	1397- 8548	1397- 9669	N.L.A.
270 MCM/MIE	350/ V-8	1969 - 1972	2851074 - 3385720	1347- 4180A 1	7029285 R4/4MV	823426A 1	N.S.S.	N.S.S.	N.L.A.
280 TRS	350/ V-8	1975	4176250 - 4176468	1347- 4179A 2	7040283 R4/4MV	823426A 1	N.S.S.	N.S.S.	N.L.A.
280 TRS	350/ V-8	1975 - 1976	4176469 - 4770199	1347- 5981A 1	7044290 R4/4MV	823426A 1	N.S.S.	N.S.S.	N.L.A.
300 MR/TRS	350/ V-8	1985 - 1986	6668677 - 0B430367	1347- 7498A 7	17059280 R4/4MV	823426A 1	N.S.S.	N.S.S.	N.L.A.
350 Mag Alpha	350/ V-8	1986 - 1991	0A635178 - 0D617327	1347- 8289A 1	17080562 R4/4MV	823426A 1	1397- 8548	1397- 9669	N.L.A.
350 Mag Alpha	350/ V-8	1992 - 1995	0D617328 - 0F600999	3310-806970A 1	9770SA WEBER	809065	811534	811537	N.L.A.
350 Mag Alpha	350/ V-8	1996 - 1997	0F601000 - 0K999999	3310-807262A 2	9781 WEBER	809064	811534	811537	N.L.A.
350 Mag Ski	350/ V-8	1991 - 1996	0D505450 - 0K040399	3310-806970A 1(6)	9770SA WEBER	809065	811534	811537	N.L.A.(11)
350 Mag Ski	350/ V-8	1991 - 1997	0D505450 - 0K999999	3310-807262A 2(6)	9781 WEBER	809064	811534	811537	N.L.A.(11)
350 Mag Ski	350/ V-8	1997	0K040400 - 0K999999	3310-860371A 1(13)	9781SB WEBER	809064	811534	811537	N.L.A.(12)
5.7L (2 bbl.)	350/ V-8	1996 - 1997	0F601000 - 0K999999	3310-807312A 1	M2/MERCARB	3302-804844002	3302-804689	3302- 9655 1	3310-807312A 1
5.7L (Gen +) (2 bbl.)	350/ V-8	1998 - 2002	0L010037 - 0M599999	3310-861245A 1	M2/MERCARB	3302-804844002	3302-804689	3302- 9655 1	3310-864943A01
5.7L (Gen +) (2 bbl.)	350/ V-8	2002 - 2004	0M600000 - 0W300754	3310-864943A01	M2/MERCARB	3302-804844002	3302-804689	3302- 9655 1	3310-864943A01
5.7L (Gen +) (2 bbl.)	350/ V-8	2000 - 2004	0L015751 - 0W300754	3310-864943A01	M2/MERCARB	3302-804844002	3302-804689	3302- 9655 1	865962A02(17)
5.7L (Gen +) (2 bbl.)	350/ V-8	2004 - 2015	0W300755 and up	3310-866143A03	M2/MERCARB/TKS	3302-804844002	3302-804689	3302- 9655 1	3310-866143A03
5.7L Alpha	350/ V-8	1988 - 1993	0B773305 - 0F000454	1347- 9662A 4	17080561 R4/4MV	823426A 1	1397- 8548	1397- 9669	N.L.A.
5.7L Alpha	350/ V-8	1993 - 1994	0F000455 - 0F273497	3310-805484A 1	9661 WEBER	809065	811534	N.L.A.	N.L.A.
5.7L Alpha	350/ V-8	1993 - 1994	0F000455 - 0F273497	3310-806761A 1	9665S WEBER	809064	811534	N.L.A.	N.L.A.
5.7L Alpha	350/ V-8	1994 - 1995	0F273498 - 0F600999	3310-806761A 3	9665S WEBER	809064	811534	811537	3310-806761A 3
5.7L Bravo (w/o High Rise Intake)	350/ V-8	1988 - 1991	0B773305 - 0D617327	1347- 9662A 4	17080561 R4/4MV	823426A 1	1397- 8548	1397- 9669	N.L.A.
5.7L Bravo (w/ High Rise Intake)	350/ V-8	1988 - 1991	0B773305 - 0D617327	1347- 8289A 1	17080562 R4/4MV	823426A 1	1397- 8548	1397- 9669	N.L.A.
5.7L Bravo	350/ V-8	1992 - 1995	0D617328 - 0F600999	3310-806970A 1	9770SA WEBER	809065	811534	811537	N.L.A.
5.7L MIE	350/ V-8	1988 - 1992	0B788152 - 0D715493	1347- 9662A 4	17080561 R4/4MV	823426A 1	1397- 8548	1397- 9669	N.L.A.
5.7L MIE	350/ V-8	1992 - 1994	0D715494 - 0F349999	3310-806761A 2(14)	9665S WEBER	809064	811534	N.L.A.	3310-806761A 2
5.7L MIE	350/ V-8	1994	0F025000 - 0F349299	3310-805484A 1(8)	9661 WEBER	809065	811534	N.L.A.	N.L.A.
5.7L MIE	350/ V-8	1995	0F349300 - 0F622099	3310-806761A 3	9665S WEBER	809064	811534	811537	3310-806761A 3
5.7L MIE	350/ V-8	1996 - 1997	0F622100 - 0K999999	3310-807262A 2	9781 WEBER	809064	811534	811537	N.L.A.
5.7L MIE (2 bbl.)	350/ V-8	1998 - 2002	0L002003 - 0M316999	3310-861245A 1	M2/MERCARB	3302-804844002	3302-804689	3302- 9655 1	3310-864943A01
5.7L MIE (2 bbl.)	350/ V-8	2002 - 2004	0M317000 - 0W090899	3310-864943A01	M2/MERCARB	3302-804844002	3302-804689	3302- 9655 1	3310-864943A01
5.7L MIE (2 bbl.)	350/ V-8	2000 - 2004	0L390600 - 0W090899	3310-864943A01	M2/MERCARB	3302-804844002	3302-804689	3302- 9655 1	865962A02(17)
5.7L MIE (2 bbl.)	350/ V-8	2004 - 2015	0W090900 and up	3310-866143A03	M2/MERCARB/TKS	3302-804844002	3302-804689	3302- 9655 1	3310-866143A03
5.7L Ski	350/ V-8	1985 - 1987	0A338553 - 0B514626	1347- 9415T	17085013 R4/4MV	823426A 1	1397- 8548	1397- 9669	9415T
5.7L Ski	350/ V-8	1987 - 1995	0B514627 - 0F775199	3310-806761A 2	9665S WEBER	809064	811534	N.L.A.	3310-806761A 2
5.7L Ski	350/ V-8	1987 - 1995	0F450000 - 0F775199	3310-805484A 1	9661 WEBER	809065	811534	811537	3310-806761A 3
5.7L Ski (2 bbl.)	350/ V-8	1996 - 1997	0F775200 - 0K999999	3310-807312A 1	M2/MERCARB	3302-804844002	3302-804689	3302- 9655 1	3310-807312A 1
5.7L Ski (Gen +) (2 bbl.)	350/ V-8	1998 - 2002	0L002005 - 0M316999	3310-861245A 1	M2/MERCARB	3302-804844002	3302-804689	3302- 9655 1	3310-864943A01
5.7L Ski (Gen +) (2 bbl.)	350/ V-8	2002 - 2004	0M317000 - 0W090899	3310-864943A01	M2/MERCARB	3302-804844002	3302-804689	3302- 9655 1	3310-864943A01
5.7L Ski (Gen +) (2 bbl.)	350/ V-8	2000 - 2004	0L390600 - 0W090899	3310-864943A01	M2/MERCARB	3302-804844002	3302-804689	3302- 9655 1	865962A02(17)
5.7L Ski (Gen +) (2 bbl.)	350/ V-8	2004 - 2015	0W090900 and up	3310-866143A03	M2/MERCARB/TKS	3302-804844002	3302-804689	3302- 9655 1	3310-866143A03
5.7LX (4 bbl.)	350/ V-8	1996 - 1997	0F601000 - 0K999999	3310-807262A 2	9781 WEBER	809064	811534	811537	N.L.A.
233 MCM & MIE (Ford)	351/ V-8	1975 - 1977	4173000 - 4465029	1376- 5744A 1	7044187 R2/2GC	1397- 5831	N.S.S.	N.S.S.	N.L.A.
233 MCM & MIE (Ford)	351/ V-8	1975 - 1977	4465030 - 4902304	1376- 6152A 1	17056197 R2/2GC	1397- 5831	N.S.S.	N.S.S.	N.L.A.

MERCURY® MERCUISER®



# MERCURY® MERCUISER® FUEL SYSTEM

MERCURY® MERCUISER®

Model	CID/ # Cyl.	Year Range	Serial # Range	Original Carb P/N	Original Mfg. P/N Code / Model	Carb Repair Kit	Needle & Seat	Accel Pump	Replacement Carb
255 MCM/MIE (Ford)	351/ V-8	1973 - 1974	3258728 - 4175499	1356- 5169	D2JL9510E H4/4160	N.L.A.	N.L.A.	N.L.A.	N.L.A.
325 MCM/MIE	427/ V-8	1969 - 1970	2278747 - 3042730	1347- 3342(1)	7027080 R4/4MV	823426A 1	N.S.S.	N.S.S.	N.L.A.
325 MCM/MIE	427/ V-8	1971 - 1972	3042731 - 3780449	1347- 4533A 1(1)	7041831 R4/4MV	823426A 1	N.S.S.	N.S.S.	N.L.A.
325 MCM/MIE	427/ V-8	1969 - 1972	2278747 - 3780449	1347- 3689A 1(4)	7029280 R4/4MV	823426A 1	N.S.S.	N.S.S.	N.L.A.
330 MCM	454/ V-8	1977 - 1978	4623115 - 5027230	1347- 6493A 1	17057287 R4/4MV	823426A 1	N.S.S.	N.S.S.	N.L.A.
330 MCM	454/ V-8	1977 - 1981	5027231 - 6083144	1347- 7363A 1	17059290 R4/4MV	823426A 1	N.S.S.	N.S.S.	N.L.A.
330 MCM	454/ V-8	1982 - 1987	6083145 - 0B816540	1347- 8291A 3	17080563 R4/4MV	823426A 1	N.S.S.	N.S.S.	N.L.A.
330 MIE	454/ V-8	1977 - 1978	4623115 - 5226384	1347- 6493A 1	17057287 R4/4MV	823426A 1	N.S.S.	N.S.S.	N.L.A.
330 MIE	454/ V-8	1979 - 1980	5226385 - 5889913	1347- 7366A 1	17059287 R4/4MV	823426A 1	N.S.S.	N.S.S.	N.L.A.
340 MIE	454/ V-8	1981 - 1987	5889914 - 0D788365	1347- 8288A 1	17080560 R4/4MV	823426A 1	1397- 8548	1397- 9669	N.L.A.
370	454/ V-8	1978 - 1987	4179554 - 0B714586	1347- 7498A 2	17059280 R4/4MV	823426A 1	N.S.S.	N.S.S.	N.L.A.
400	454/ V-8	1980 - 1986	4179554 - 0B457644	1347- 7498A 2	17059280 R4/4MV	823426A 1	N.S.S.	N.S.S.	N.L.A.
420	454/ V-8	1987 - 1989	0A398941 - 0B622418	13549A 4	H4	13220	N.S.S.	N.L.A.	N.L.A.
425	454/ V-8	1990 - 1993	0B622419 - 0D937011	13549A 4	H4	13220	N.S.S.	N.L.A.	N.L.A.
440	454/ V-8	1983 - 1986	4179554 - 0B485220	1393- 8862A 1	H4	13220	N.S.S.	N.S.S.	N.L.A.
450	454/ V-8	1995 - 1996	0F347100 - 0F347277	13549A14	H4	13220	N.S.S.	N.L.A.	N.L.A.
454 Mag Alpha	454/ V-8	1986 - 1988	0A631894 - 0B785148	1347- 8291A 3	17080563 R4/4MV	823426A 1	1397- 8548	1397- 9669	N.L.A.
454 Mag Bravo	454/ V-8	1988 - 1992	0B721206 - 0D805068	1347- 7498A 2	17059280 R4/4MV	823426A 1	N.S.S.	N.S.S.	N.L.A.
454 Mag Bravo	454/ V-8	1992 - 1994	0D805069 - 0F304999	3310-806755A 1	9779 WEBER	809064	811534	N.L.A.	N.L.A.
454 Mag Bravo	454/ V-8	1995 - 1997	0F305000 - 0K999999	3310-806755A 2	9779 WEBER	809064	811534	N.L.A.	N.L.A.
525 SC	454/ V-8	1991 - 1995	0D456000 - 0F348963	12377A 5	H4	8M0050786	N.S.S.	N.S.S.	N.L.A.(2)
525 SC	454/ V-8	1991 - 1999	0D456000 - 0L415623	12377A 6	H4	8M0050786	N.S.S.	N.S.S.	N.L.A.(3)
7.4L Bravo I/II	454/ V-8	1988 - 1991	0B771113 - 0D603117	1347- 8291A 3	17080563 R4/4MV	823426A 1	1397- 8548	1397- 9669	N.L.A.
7.4L Bravo I/II	454/ V-8	1992 - 1994	0D603118 - 0F351999	3310-806969A 2	9780 WEBER	809064	811534	N.L.A.	N.L.A.
7.4L Bravo I/II	454/ V-8	1995 - 1997	0F352000 - 0K999999	3310-806969A 1	9780 WEBER	809064	811534	N.L.A.	3310-8M0047212
7.4L/Bravo III	454/ V-8	1993 - 1996	0D838819 - 0F800699	3310-806755A 2	9779 WEBER	809064	811534	N.L.A.	N.L.A.
7.4L/Bravo III	454/ V-8	1996 - 1997	0F800700 - 0K999999	3310-806969A 1	9780 WEBER	809064	811534	N.L.A.	3310-8M0047212
7.4L MIE	454/ V-8	1988 - 1992	5889914 - 0D715493	1347- 8288A 1	17080560 R4/4MV	823426A 1	1397- 8548	1397- 9669	N.L.A.
7.4L MIE with Hurth	454/ V-8	1992 - 1994	0D715494 - 0F349999	3310-806969A 2	9780 WEBER	809064	811534	N.L.A.	N.L.A.
7.4L MIE with B/W	454/ V-8	1992 - 1994	0D715494 - 0F349999	3310-806969A 3	9780 WEBER	809064	811534	N.L.A.	N.L.A.
7.4L MIE	454/ V-8	1995 - 1997	0F350000 - 0K999999	3310-806969A 1	9780 WEBER	809064	811534	N.L.A.	3310-8M0047212
460	482/ V-8	1983 - 1986	4179554 - 0B485220	1393- 8862A 1	H4	13220	N.S.S.	N.S.S.	N.L.A.
465	502/ V-8	1990 - 1992	0C849992 - 0F213244	N.L.A.	H4	13220	N.S.S.	N.L.A.	N.L.A.(2)
465	502/ V-8	1990 - 1992	0C849992 - 0F213244	N.L.A.	H4	13220	N.S.S.	N.L.A.	N.L.A.(3)
500	502/ V-8	1994 - 1995	0F213293 - 0F615766	13549A12	H4	13220	N.S.S.	N.L.A.	N.L.A.(3)
500	502/ V-8	1996 - 1998	0F615767 - 0L001772	13549A15	H4	13220	N.S.S.	N.L.A.	N.L.A.(3)
500 (Gen +)	502/ V-8	1999	0L414639 - 0L601036	13549T21	H4	13220	N.S.S.	N.L.A.	N.L.A.(3)
502 Mag	502/ V-8	1990 - 1992	0C878221 - 0D824588	1347-814623A 2	17089112 R4/4MV	823426A 1	1397- 8548	1397- 9669	N.L.A.
502 Mag	502/ V-8	1992 - 1993	0D824589 - 0F114528	3310-806971A 1	9782 WEBER	809064	811534	N.L.A.	N.L.A.
575	502/ V-8	1986 - 1992	0A677429 - 0D763716	12377A 2	H4	N.L.A.	N.S.S.	N.S.S.	N.L.A.
600 SC	502/ V-8	1991 - 2000	0D456489 - 0L601186	3312-821030A15	H4	N.L.A.	N.S.S.	N.S.S.	N.L.A.(7)
600 SC	502/ V-8	1991 - 2000	0D456489 - 0L601186	3312-821030A16	H4	N.L.A.	N.S.S.	N.S.S.	N.L.A.(5)
8.2L MIE	502/ V-8	1990 - 1992	0C878221 - 0D857199	1347-814623A 2	17089112 R4/4MV	823426A 1	1397- 8548	1397- 9669	N.L.A.
8.2L MIE	502/ V-8	1990 - 1992	0C878221 - 0D857199	3310-817693A 1	9774 WEBER	809064	811534	N.L.A.	N.L.A.
8.2L MIE	502/ V-8	1993 - 1996	0D857200 - 0F819619	3310-806971A 1	9782 WEBER	809064	811534	N.L.A.	N.L.A.
500 Bulldog	540/ V-8	1990 - 1995	0C577254 - 0F348987	13549A10	H4	13220	N.S.S.	N.L.A.	N.L.A.(3)
500 Bulldog	540/ V-8	1995 - 2001	0F615762 - 0M050281	13549A23	H4	13220	N.S.S.	N.L.A.	N.L.A.(3)

Not all parts listed are available for the European, C.I.S., Africa and Middle East Markets.  
For more information, please contact your local Mercury, Mariner, MerCruiser or Quicksilver Office.

# MERCURY® MERCUISER® FUEL SYSTEM

Model	CID/ # Cyl.	Year Range	Serial # Range	Original Carb P/N	Original Mfg. P/N Code / Model	Carb Repair Kit	Needle & Seat	Accel Pump	Replacement Carb
800 SC	572/ V-8	1993 - 1996	0D763836 and up	3312-821030A17	H4	N.L.A.	N.S.S.	N.S.S.	N.L.A.(7)
800 SC	572/ V-8	1993 - 1996	0D763836 and up	3312-821030A18	H4	N.L.A.	N.S.S.	N.S.S.	N.L.A.(5)

- (1) Automatic choke
- (2) Black
- (3) Blue
- (4) Electric choke
- (5) Front (Blue)
- (6) In-Line
- (7) Rear (Blue)
- (8) Spacer mounted
- (9) Use if original carb is MerCarb
- (10) Use if original carb is Rochester
- (11) Use w/ in-line transmission
- (12) Use w/ V-drive transmission
- (13) V-drive
- (14) Wedge mounted
- (17) TKS Retrofit Kit

## FUEL PUMPS

### FUEL PUMP



**86234A05**

Fuel pump mounted with filter bowl facing up  
Fits MCM 120/2.5L, 140/3.0L, 470/485/488 & 160/165/200 (I/L 6 cyl.)

### FUEL PUMP



**32722**

Fits MCM 120 (4 cyl.) & 140, 150, 160 (6 cyl.)

### FUEL PUMP



**8M0073435**

Fuel pump mounted with filter bowl facing down  
Fits 4 cyl. (2.5L, 3.0L & 3.7L) engines

### FUEL PUMP

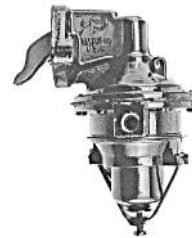

**862077A 1**

Fits MCM 175, 185, 205 & 4.3L/LX

**FUEL PUMP**



**8M0058164**

Fits GM V-8 (305 & 350 cid) engines

**FUEL PUMP**



**86246T**

Fits MCM/MIE 898, 228, 250, 255, 260 & 280

**FUEL PUMP**



**62092T**

Fits MCM/MIE Ford 215, 225, 233, 255 & 888

**FUEL PUMP**



**86247T**

Fits MCM/MIE 325, 330, 350 & 390

**FUEL PUMP**



**862048A 1**

Fits MCM/MIE 330, 340, 7.4L, 454 Mag, 370, 400, 420, 425 & 440

**FUEL PUMP**



**861677T**

Fits GM V-8 (454 & 502 cid) engines

**FUEL PUMP**



**92864**

Fits MCM 460, 500 Bulldog, 525SC & 575

**FUEL PUMP**



**862049A 1**

Fits MCM 465, 502 Mag, 600SC & MIE 8.2L

## FUEL PUMP



**889275T**

Fits MCM 500 EFI, 525 EFI & 575 SCi

## FUEL PUMP



**861677A 2**

Fits MCM 500 (Gen+)

## FUEL PUMP - ELECTRIC



**861155A16**

low pressure lift pump  
Fits MCM 100 Vazer

## FUEL PUMP - ELECTRIC



**8M2001321**

High pressure pump  
Fits MCM 100 Vazer

## FUEL PUMP - ELECTRIC



**861155A 6**

low pressure  
Fits MCM 262 Mag EFI, 4.3L/LX & 4.3LH/LXH

## FUEL PUMP - ELECTRIC



**861155A 3**

low pressure  
Fits MCM/MIE 4.3L/LH, 5.0L Gen+, 5.7L Gen+; also used as boost pump on MCM/MIE 5.0L MPI, 350 Mag MPI, MX 6.2L MPI & 496 Mag/8.1S

## BOOST PUMP KIT



**862264A 7**

Helps minimize vapor locking  
Fits MCM/MIE 4.3L, 5.0L, 5.7L & 6.2L EFI/MPI engines

## FUEL PUMP - ELECTRIC



**861156A 1**

High pressure, NLA  
Order appropriate Pump/Cooler Kit 861156A02, A03 or A04  
Ref. MCM S.B. 2004-05  
Fits GM V-6 & V-8 (305, 350, 377, 454, 496 & 502 cid) EFI engines

**FUEL PUMP/COOLER KIT**



**861156A02**

Fits GM V-6 & V-8 (305, 350, 377, 454 & 502 cid) EFI engines (s/n 0L000000-0M299999); also fits all 496 cid models; and Black Scorpion models (s/n 0L00000 and up)

**FUEL PUMP/COOLER KIT**



**861156A03**

Fits GM V-6 & V-8 (305, 350 & 377 cid) MPI engines (s/n 0M300000 and up)

**FUEL PUMP/COOLER KIT**



**861156A04**

Fits GM V-6 & V-8 (305, 350, 454 & 502 cid) engines w/ cool fuel (s/n 0K999999 and below)

**FUEL PUMP/REGULATOR KIT**



**866169T01**

High pressure pump w/ regulator  
Fits GM V-8 (305, 350, 377, 496 & 502 cid) engines w/ Gen III Cool Fuel module

**FUEL PUMP - ELECTRIC**



**866170A01**

Low pressure lift pump  
Fits GM V-8 (305, 350, 377 496 & 502 cid) engines w/ Gen III Cool Fuel module

**FUEL PUMP**



**849930T02**

Fits MCM 500 EFI & 575 SCi

**FUEL PUMP - ELECTRIC**



**841080T01**

Fits MCM 525 EFI

**MERCUISER FUEL FILTERS - FUEL PUMP**

**FUEL PUMP FILTER**



**35-865461**

Fits the MCM 100 Vazer's low pressure lift pump

## FUEL PUMP FILTER



### 35-8M0046751

Fits MCM 120/2.5L, 140/3.0L/LX, 3.7L, 3.8L & 4.3L engines.  
Priced individually, sold @ multiples of 2  
Mercury Branded, Clamshell Package Point of Sale Packaged.

### 35-8M0046752

Fits MCM 120/2.5L, 140/3.0L/LX, 3.7L, 3.8L & 4.3L engines.  
Priced individually, sold @ multiples of 2  
Quicksilver Branded, Clamshell Package Point of Sale Packaged.

## FUEL PUMP FILTER



### 35-49088T 2

Used on all MerCruiser engines with Rochester 2 barrel carburetor and Carter fuel pump.  
Priced individually, sold @ multiples of 2  
Mercury Branded, Clamshell Package Point of Sale Packaged.

### 35-49088Q 2

Used on all MerCruiser engines with Rochester 2 barrel carburetor and Carter fuel pump.  
Priced individually, sold @ multiples of 2  
Quicksilver Branded, Clamshell Package Point of Sale Packaged.

MERCURY® MERCUISER® COOLING SYSTEM

MERCUISER WATER PUMP REPAIR KITS - SEA WATER

BODY/ IMPELLER KIT



46- 72774A89

Fits plastic 2 pc. body sea water pump

BODY/ IMPELLER KIT



46-807151A14

Fits plastic 1 pc. body sea water pump

BODY/ IMPELLER KIT



46-862914A13

Fits 2000 & newer MCM V-6 & V-8 (305, 350 & 496 cid) engines with the brass sea water pump

REAR COVER ASSEMBLY



862776A01

Plastic housing with stainless steel wear plate  
Fits current small block brass seawater pump w/o air fittings

REAR COVER ASSEMBLY



863674A05

Brass housing with stainless steel wear plate  
Fits current small block brass seawater pump w/ air fittings

REAR COVER ASSEMBLY



862776A02

Brass housing, no stainless steel wear plate  
Fits MCM/MIE 496/8.1L brass seawater pump w/o air fittings (s/n 0M025000-0W059999)

REAR COVER ASSEMBLY



863674A04

Brass housing with stainless steel wear plate  
Fits MCM/MIE 496/8.1L brass seawater pump w/ air fittings (s/n 0W060000 and above)

**SEA WATER PUMP IMPELLER KIT**



**47- 59362K08**

Includes wear plates  
Fits plastic 1 & 2 pc. body sea water pumps.  
Mercury Branded, Clamshell Package Point of Sale Packaged.

**47- 59362Q08**

Includes wear plates  
Fits plastic 1 & 2 pc. body sea water pumps.  
Quicksilver Branded, Clamshell Package Point of Sale Packaged.

**SEA WATER PUMP IMPELLER KIT**



**47- 59362A 4**

Fits plastic 2 pc. body sea water pump

**SEA WATER PUMP IMPELLER KIT**



**47- 59362T 6**

Fits plastic 1 pc. body sea water pump

**SEA WATER PUMP IMPELLER KIT**



**47-862232A 2**

Fits 2000 & newer MCM V-6 & V-8 (305, 350 & 496 cid) engines with the brass sea water pump

**MERCRUISER WATER PUMP REPAIR KITS - DRIVE**

**WATER PUMP UPPER HOUSING REPAIR KIT**



**46- 96148A 8**

Fits Mercury/Mariner 65 hp (4 cylinder) through V-6 outboards with short-vane impellers and fits MerCruiser I/R/MR/Alpha drives (s/n 2495186-0D469858).  
Quicksilver Branded

**WATER PUMP UPPER REPAIR KIT**

**46- 96148T 8**

Includes plastic pump housing assembly, impeller, face plate, gaskets, drive key or pin, water tube guide sleeve, "O" rings and gearlube fill & vent screw seals. (Base not included)

Fits Mercury/Mariner 65 hp (4 cylinder) through V-6 outboards with short-vane impellers and fits MerCruiser I/R/MR/Alpha drives (s/n 2495186-0D469858).  
Mercury Branded, Clamshell Package Point of Sale Packaged.

**46- 96148Q 8**

Includes plastic pump housing assembly, impeller, face plate, gaskets, drive key or pin, water tube guide sleeve, "O" rings and gearlube fill & vent screw seals. (Base not included)

Fits Mercury/Mariner 65 hp (4 cylinder) through V-6 outboards with short-vane impellers and fits MerCruiser I/R/MR/Alpha drives (s/n 2495186-0D469858).  
Quicksilver Branded, Clamshell Package Point of Sale Packaged.

**WATER PUMP UPPER REPAIR KIT**



**817275K05**

Fits Alpha One Gen II drives and Vazer  
Mercury Branded, Clamshell Package Point of Sale Packaged.

**WATER PUMP BASE KIT**



**46- 48748T 1**

Fits 120, 140 & 160 drives w/ flush screw in gear hsg.



**WATER PUMP BASE KIT**



**46- 57234T 1**

Fits MC I & R drives w/o flush screw in housing.

**WATER PUMP BASE KIT**

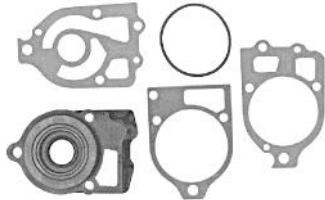

**46- 44292A 3**

Fits MR & Alpha One drives (1985-1990)

**46- 44292Q03**

Fits MR & Alpha One drives (1985-1990)

Priced individually, sold @ multiples of 2

Quicksilver Branded, Clamshell Package Point of Sale Packaged.

**WATER IMPELLER REPAIR KIT**



**47- 89984T 5**

Includes new impeller, face plate w/ face plate gaskets, drive key or pin, water tube guide sleeve, "O" rings and geartube fill & vent screw seals.

Fits Mercury/Mariner 65 hp (4 cylinder) through V-6 outboards with short-vane impellers and fits MerCruiser I/R/MR/Alpha drives (s/n 2495186-0D469858).

Mercury Branded, Clamshell Package Point of Sale Packaged.

**47- 89984Q 5**

Fits Mercury/Mariner 65 hp (4 cylinder) through V-6 outboards with short-vane impellers and fits MerCruiser I/R/MR/Alpha drives (s/n 2495186-0D469858). Quicksilver Branded, Clamshell Package Point of Sale Packaged.

**WATER PUMP IMPELLER REPAIR KIT**

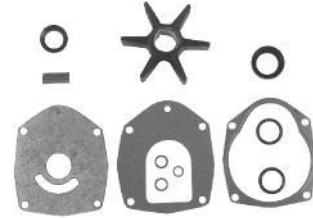

**47- 43026K06**

Fits 40/45/50/60 FourStroke Bigfoot, 60 (3 cyl.) BigFoot, 75-125 (all 3 & 4 cylinder models having pump cover screws without insulators, USA 0A996142 & above and BEL 9483121 & above), 75/90/115 (1.7L and prior) FourStroke, V-200/225/250 (3.0L), Verado 4.80 dia. torpedo gearcases and MerCruiser Alpha One Gen II drives.

Mercury Branded, Clamshell Package Point of Sale Packaged.

**WATER IMPELLER REPAIR KIT**

**47- 43026Q06**

Fits 40/45/50/60 FourStroke Bigfoot, 60 (3 cyl.) BigFoot, 75-125 (all 3 & 4 cylinder models having pump cover screws without insulators, USA 0A996142 & above and BEL 9483121 & above), 75/90/115 (1.7L and prior) FourStroke, V-200/225/250 (3.0L), Verado 4.80 dia. torpedo gearcases and MerCruiser Alpha One Gen II drives.

Quicksilver Branded, Clamshell Package Point of Sale Packaged.

**WATER PUMP REPAIR KITS CHART**

**MCM Water Pump Impellers & Kits**

Model	Serial # Range	Impeller Only	Impeller Repair Kit	Lower Base Kit	Upper Housing Kit
MC-I w/ plastic flush screw in lower gear housing	2495186 - 2763441	47- 89984T 4	47- 89984T 5	46- 48748T 1	46- 96148A 8
MC-I w/o flush screw in gear housing	2763442 - 6854392	47- 89984T 4	47- 89984T 5	46- 57234T 1(1)	46- 96148A 8
MR/Alpha One	6854393 - 0D469858	47- 89984T 4	47- 89984T 5	46- 44292A 3	46- 96148A 8
Alpha One Gen II	0D469859 and up	47- 43026T 2	47- 43026K06	N/A	817275K05
Vazer	0W995000 and up	47- 43026T 2	47- 43026K06	N/A	817275K05
Bravo I/II/III w/ 2 pc body sea water pump	0B664190 and up	47- 59362T 1(3)	47- 59362A 4	N/A	N/A
Bravo I/II/III w/ 1 pc body sea water pump	0B664190 and up	47- 59362T 1(3)	47- 59362T 6	N/A	N/A
Bravo I/II/III w/ brass sea water pump	0M100001 and up	47-862232A 2(4)	N/A	N/A	N/A

(1) Models which have been retrofitted with an Alpha style Gear Housing (no pre-load pin in the top of the drive shaft) must use MR/Alpha style parts.

(2) An Upper Housing Kit combined with a Lower Base Kit will yield a complete water pump assembly.

(3) Engine mounted sea water pump application, for all engines w/o the block drain feature.

(4) Engine mounted sea water pump application, for all engines with the block drain feature.

**Not all parts listed are available for the European, C.I.S., Africa and Middle East Markets.**  
**For more information, please contact your local Mercury, Mariner, MerCruiser or Quicksilver Office.**

## MERCUISER THERMOSTAT KITS

### THERMOSTAT KIT



#### 59078T 3

140 degree  
Fits 1998 and older MCM GM in-line 4 & 6 cyl. Engines  
Priced individually, sold @ multiples of 2  
Mercury Branded, Clamshell Package Point of Sale Packaged.

#### 59078Q 3

140 degree  
Fits 1998 and older MCM GM in-line 4 & 6 cyl. Engines  
Priced individually, sold @ multiples of 2  
Quicksilver Branded, Clamshell Package Point of Sale Packaged.

### THERMOSTAT KIT



#### 807252T 5

160 degree  
Fits 1987 and newer GM engines with standard cooling requiring a 160 degree thermostat.  
Mercury Branded, Clamshell Package Point of Sale Packaged.

#### 807252Q 5

160 degree  
Fits 1987 and newer GM engines with standard cooling requiring a 160 degree thermostat.  
Quicksilver Branded, Clamshell Package Point of Sale Packaged.

### THERMOSTAT KIT



#### 99155T 2

160 degree  
Fits MCM 470/488 (s/n 6218037 and newer) & 3.7L engines

### THERMOSTAT KIT



#### 807252T 4

140 degree  
Fits 1983 and newer GM V-6 and V-8 engines with standard cooling requiring a 140-degree thermostat (except high performance engines).  
Mercury Branded, Clamshell Package Point of Sale Packaged.

#### 807252Q 4

140 degree  
Fits 1983 and newer GM V-6 and V-8 engines with standard cooling requiring a 140-degree thermostat (except high performance engines).  
Quicksilver Branded, Clamshell Package Point of Sale Packaged.

### THERMOSTAT KIT



#### 99155T 1

160 degree  
Fits GM V-6 & V-8 engines with closed cooling (1998 and newer)

### THERMOSTAT KIT



#### 807252T 3

140 degree  
Fits 1982 and older Ford and GM V-8 engines with standard cooling & 1996 and older hi-performance models. Also fits engines with closed cooling.  
Mercury Branded, Clamshell Package Point of Sale Packaged.

#### 807252Q 3

140 degree  
Fits 1982 and older Ford and GM V-8 engines with standard cooling & 1996 and older hi-performance models. Also fits engines with closed cooling.  
Quicksilver Branded, Clamshell Package Point of Sale Packaged.

HOSES - WATER

CIRCULATING PUMP HOSE



**32-8M0071007**

Fits MCM 120/2.5L, 140/3.0L & 160/165

CIRCULATING PUMP HOSE



**32-861590A05**

Fits MCM/MIE GM V-6 and V-8 (305, 350 & 377 cid) engines

CIRCULATING PUMP HOSE



**32-33189**

Fits MCM/MIE GM V-8 283, 305, 327 & 350 cid engines

CIRCULATING PUMP HOSE



**32-54570**

Fits MCM/MIE Ford V-8 302 & 351 cid engines

CIRCULATING PUMP HOSE



**32-89718 1**

Fits MCM/MIE GM V-8 (427, 454 & 502 cid) engines

CIRCULATING PUMP HOSE



**32-89718 3**

Fits MCM 7.4L Bravo III (Gen V) & 454 Mag Bravo (Gen V & VI)

CIRCULATING PUMP HOSE



**32-861183**

Fits MCM/MIE 7.4L MPI (L29)

CIRCULATING PUMP HOSE



**32-842416A 1**

Fits MCM 500 EFI

## CIRCULATING PUMP HOSE



**32-847677A01**

Fits MCM 500 Bulldog & 525 SC (Gen V & VI)

**32-847677A01**

Fits MCM 500 Bulldog & 525 SC (Gen V & VI)

## CIRCULATING PUMP HOSE



**32-842412A02**

Fits MCM 575 SCi, 600 SC (Gen V & VI) & 800 SC (Gen V)

## HOSE - MOLDED



**32-807661**

Transom to oil cooler  
1-1/4 in. (32 mm) I.D. at one end; 3/4 in. (19 mm) I.D. at other end of hose  
Fits MCM 3.0L, GM V-6 & V-8 (305 & 350 cid) engines

## HOSE - MOLDED



**32-815413**

Transom to oil cooler  
1 in. (25 mm) I.D. at one end; 3/4 in. (19 mm) I.D. at other end of hose  
Fits 3.0L/LX

## HOSE - MOLDED



**32-806433**

Cooler to thermostat housing  
1 in. (25 mm) I.D. at one end; 3/4 in. (19 mm) I.D. at other end of hose  
Fits 3.0L/LX

## HOSE - MOLDED



**32-815412**

Cooler to thermostat housing  
1 in. (25 mm) I.D. at one end; 3/4 in. (19 mm) I.D. at other end of hose  
Fits 3.0L/LX

## HOSE - MOLDED



**32-47639**

Thermostat housing to exhaust manifold  
1 in. (25 mm) I.D.  
Fits GM in-line 4 & 6 cyl.

## HOSE - MOLDED



**32-52481**

Thermostat housing to exhaust manifold  
1 in. (25 mm) I.D.  
Fits GM in-line 4 & 6 cyl.

HOSE - MOLDED



**32-806993**

Thermostat housing exhaust manifold  
1 in. (25 mm) I.D.  
Fits 3.0L/LX

HOSE - MOLDED



**32-861634**

Thermostat housing to exhaust manifold  
1 in. (25 mm) I.D.  
Fits 3.0L

HOSE - MOLDED



**32- 89653**

Cylinder head to exhaust manifold  
1-1/4 in. (32 mm) I.D.  
Fits 3.7L

HOSE - MOLDED



**32- 76327**

Engine circulating pump to intake manifold  
1-1/2 in. (38 mm) I.D. at one end; 1-1/4 in. (32 mm) I.D. at other end of hose  
Fits 3.7L models

HOSE - MOLDED



**32- 77245**

Thermostat housing to heat exchanger  
1-1/4 in. (32 mm) I.D.  
Fits 3.7L models

HOSE - MOLDED



**32- 98033A 3**

Transom to thermostat housing  
1-1/4 in. (32 mm) I.D. at ends of hose  
Fits GM V-6 and V-8 (305 & 350 cid) engines

HOSE - MOLDED



**32- 41642A 3**

Transom to oil cooler  
1-1/4 in. (32 mm) I.D. at ends of hose  
Fits MCM V-6 engines

HOSE - MOLDED



**32- 88795**

Seawater pump to oil cooler  
1-1/4 in. (32 mm) I.D.  
Fits MCM 4.3L/LX Bravo  
Fits MIE GM V-8 (305 & 350 cid) engines

## HOSE - MOLDED



**32-860205**

Seawater pump to oil cooler  
1-1/4 in. (32 mm) I.D.  
Fits MCM V-6 engines

## HOSE - MOLDED



**32-806209 1**

Cooler to thermostat housing  
1-1/4 in. (32 mm) I.D. at ends of hose  
Fits MCM V-6

## HOSE - MOLDED



**32-860206**

Oil cooler to oil cooler  
1-1/4 in. (32 mm) I.D.  
Fits 262 Mag EFI & 4.3L EFI

## HOSE - MOLDED



**32-806856**

Cooler to thermostat housing  
1-1/4 in. (32 mm) I.D.  
Fits 4.3L/LX, 5.0L/LX, 5.7L/LX & 350 Mag

## HOSE - MOLDED



**32-16012**

Cooler to thermostat housing  
1-1/4 in. (32 mm) I.D.  
Fits 4.3L/LX, 230/5.0L MIE and 260/5.7L MIE

## HOSE - MOLDED



**32-808033**

Cooler to thermostat housing  
1-1/4 in. (32 mm) I.D.  
Fits MCM/MIE V-6 & V-8 (305, 350 & 377 cid) engines

## HOSE - MOLDED



**32-88794**

Cooler to thermostat housing  
1-1/4 in. (32 mm) I.D.  
Fits MCM/MIE V-6 and V-8 (305 & 350 cid)

## HOSE - MOLDED



**32-18810**

Thermostat housing to starboard exhaust manifold  
1 in. (25 mm) I.D. at ends of hose  
Fits MCM GM V-6

**HOSE - MOLDED**



**32-41940**

Thermostat housing to starboard exhaust manifold  
1-3/8 in. (35 mm) I.D. at ends of hose  
Fits 185 & 205

**HOSE - MOLDED**



**32-87117 1**

Thermostat housing to starboard exhaust manifold  
1 in. (25 mm) I.D. at one end; 13/16 in. (21 mm) I.D. at other end of hose  
Fits 4.3L/LX and MCM/MIE V-8 (305 & 350 cid) engines

**HOSE - MOLDED**



**32-806636 1**

Thermostat housing to starboard exhaust manifold  
1 in. (25 mm) I.D. at ends of hose  
Fits MCM/MIE GM V-6 & V-8 (305 & 350 cid) engines

**HOSE - MOLDED**



**32-806636 2**

NLA - Order 32-807697  
Thermostat housing to starboard exhaust manifold  
1 in. (25 mm) I.D. at ends of hose  
Fits 262 Mag

**HOSE - MOLDED**



**32-807697**

Thermostat housing to starboard exhaust manifold  
1 in. (25 mm) I.D. at ends of hose  
Fits MCM/MIE GM V-6 & V-8 (305, 350 & 377 cid) engines

**HOSE - MOLDED**



**32-862124**

Thermostat housing to starboard exhaust manifold  
1 in. (25 mm) I.D. at ends of hose  
Fits 4.3L/LH

**HOSE - MOLDED**



**32-16021 1**

Thermostat housing to port exhaust manifold  
1 in. (25 mm) I.D. at ends of hose  
Fits MCM/MIE V-6 and V-8 (305 & 350 cid) engines

**HOSE - MOLDED**



**32-806635 1**

Thermostat housing to port exhaust manifold  
1 in. (25 mm) I.D. at ends of hose  
Fits MCM/MIE GM V-6 & V-8 (305 & 350 cid) engines

## HOSE - MOLDED



**32-860144**

Thermostat housing to port exhaust manifold  
1 in. (25 mm) I.D. at ends of hose  
Fits MCM V-6 & V-8 (305, 350 & 377 cid) engines

## HOSE - MOLDED



**32-60200**

Thermostat housing to rear of starboard exhaust manifold  
1 in. (25 mm) I.D. at ends of hose  
Fits Ford V-8 302 cid

## HOSE - MOLDED



**32-862139**

Thermostat housing to port exhaust manifold  
1 in. (25 mm) I.D. at ends of hose  
Fits 4.3L/LH

## HOSE - MOLDED



**32-60201**

Thermostat housing to rear of port exhaust manifold  
1 in. (25 mm) I.D. at ends of hose  
Fits Ford V-8 302 cid

## HOSE - MOLDED



**32-64815**

Cooler to thermostat housing  
1-1/4 in. (32 mm) I.D.  
Fits Ford 225 MIE, 233MIE & 255MIE

## HOSE - MOLDED



**32-60198**

Thermostat housing to starboard exhaust elbow  
1 in. (25 mm) I.D. at ends of hose  
Fits Ford V-8 302 cid

## HOSE - MOLDED



**32-60203**

Thermostat housing to front of exhaust manifold  
1 in. (25 mm) I.D.  
Fits Ford V-8 (302 & 351cid) engines

## HOSE - MOLDED

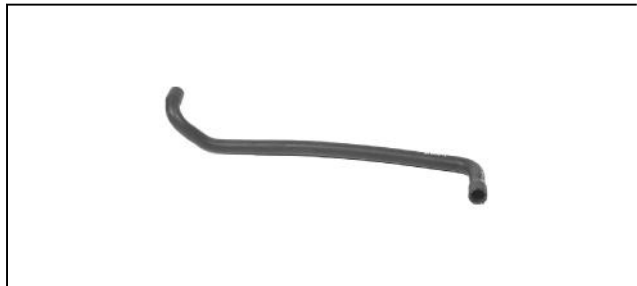

**32-60199**

Thermostat housing to port exhaust elbow  
1 in. (25 mm) I.D. at ends of hose  
Fits Ford V-8 302 cid



**HOSE - MOLDED**



**32-96246A 4**

Transom to oil cooler  
1-1/4 in. (32 mm) I.D. at ends of hose  
Fits MCM GM V-8 (305, 350 & 454 cid) engines

**HOSE - MOLDED**

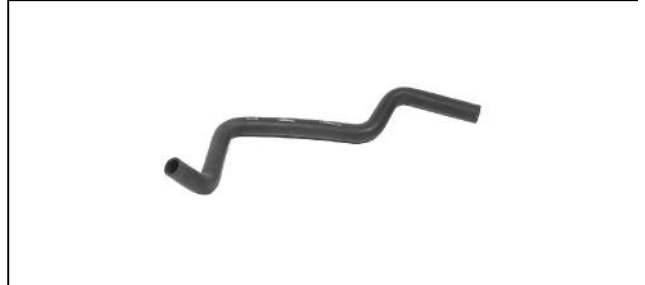

**32-808044 1**

Seawater pump to oil cooler  
1-1/4 in. (32 mm) I.D.  
Fits MCM/MIE GM V-8 (305, 350 & 377 cid) engines

**HOSE - MOLDED**

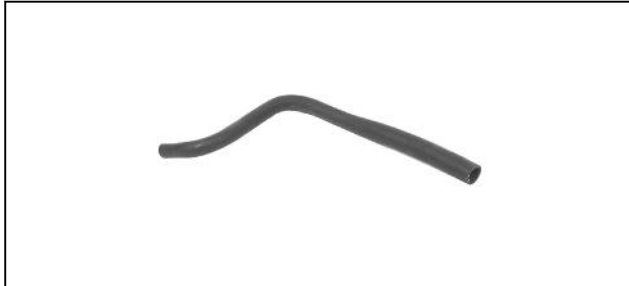

**32-815364 2**

NLA - Order 32-96246A4, Transom to oil cooler  
1-1/4 in. (32 mm) I.D. at one end; 3/4 in. (19 mm) I.D. at other end of hose  
Fits 5.7L/LX Alpha & 350 Mag Alpha

**HOSE - MOLDED**



**32-808032**

Oil cooler to oil cooler  
1-1/4 in. (32 mm) I.D.  
Fits 5.7L, 350 Mag & 377 Scorpion Tow Sports engines

**HOSE - MOLDED**



**32-93436**

Seawater pump to oil cooler  
1-1/4 in. (32 mm) I.D.  
Fits 230/5.0L & 260/5.7L MIE

**HOSE - MOLDED**

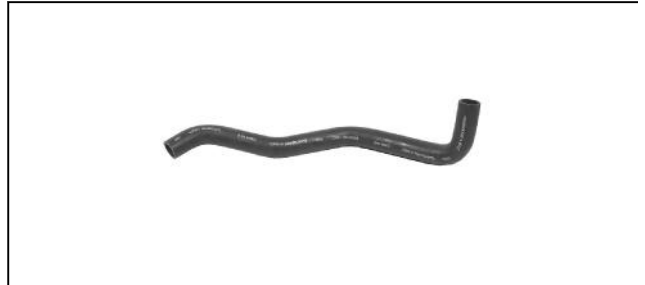

**32-808045**

Oil cooler to oil cooler  
1-1/4 in. (32 mm) I.D.  
Fits MIE V-8 350 cid and MCM/MIE V-8 (454 & 502 cid) engines

**HOSE - MOLDED**



**32-88795 2**

Seawater pump to oil cooler  
1-1/4 in. (32 mm) I.D.  
Fits MCM 5.0L/LX Bravo  
Fits MCM/MIE GM V-8 350 cid engines

**HOSE - MOLDED**



**32-860089 1**

Oil cooler to oil cooler  
1-1/4 in. (32 mm) I.D.  
Fits 5.0L, 5.7L/LX, 350 Mag & MX 6.2L MPI

## HOSE - MOLDED



### 32-16011

Cooler to thermostat housing  
1-1/4 in. (32 mm) I.D.  
Fits MCM V-8 (305, 350 & 454 cid) engines

## HOSE - MOLDED



### 32-71613

Cooler to thermostat housing  
1-1/4 in. (32 mm) I.D.  
Fits MCM/MIE GM V-8 (305 & 350 cid) engines

## HOSE - MOLDED



### 32-861512

Cooler to thermostat housing  
1-1/4 in. (32 mm) I.D. at ends of hose  
Fits 5.0L Alpha (Gen+)

## HOSE - MOLDED



### 32-844882 1

Cooler to thermostat housing  
1-1/4 in. (32 mm) I.D.  
Fits 377 Scorpion Sterndrive & 500 EFI

## HOSE - MOLDED



### 32-48132

Thermostat housing to front of exhaust manifolds  
1 in. (25 mm) I.D.  
Fits MCM/MIE V-8 (305, 327, 350, 427 & 454 cid) engines

## HOSE - MOLDED



### 32-73794

Thermostat housing to rear of starboard exhaust manifold  
1 in. (25 mm) I.D. at ends of hose  
Fits MCM/MIE GM V-8 (305 & 350 cid) engines

## HOSE - MOLDED



### 32-73795

Thermostat housing to rear of port exhaust manifold  
1 in. (25 mm) I.D. at ends of hose  
Fits MCM/MIE GM V-8 (305 & 350 cid) engines

## HOSE - MOLDED



### 32-73796

Thermostat housing to exhaust manifolds  
1 in. (25 mm) I.D. at ends of hose  
Fits MCM/MIE GM V-8 (305 & 350 cid) engines

HOSE - MOLDED



**32-817435**

Thermostat housing to port exhaust elbow  
1 in. (25 mm) I.D.  
Fits 5.0L/LX Bravo, 5.7L Bravo and 350 Mag Alpha

HOSE - MOLDED



**32-841452**

Thermostat housing to port exhaust elbow  
1 in. (25 mm) I.D.  
Fits 377 Scorpion (Sterndrive)

HOSE - MOLDED



**32- 19403**

Heat exchanger to exhaust manifold  
1 in. (25 mm) I.D. at ends of hose  
Fits 5.7L & 7.4 MIE

HOSE - MOLDED



**32- 92837**

Heat exchanger to oil cooler  
1-1/4 in. (32 mm) I.D.  
Fits 5.0L, 5.7L & 7.4L

HOSE - MOLDED



**32-897145**

Connector to seawater pump  
1-1/4 in. (32 mm) I.D.  
Fits 7.4L & 8.2L MIE

HOSE - MOLDED



**32- 18159 1**

Seawater pump to oil cooler  
1-1/4 in. (32 mm) I.D.  
Fits 7.4L Bravo

HOSE - MOLDED



**32- 18320**

Seawater pump to oil cooler  
1-1/4 in. (32 mm) I.D.  
Fits 454 Mag Bravo

HOSE - MOLDED



**32-805251**

Seawater pump to oil cooler  
1-1/4 in. (32 mm) I.D.  
Fits MCM 502 Mag

## HOSE - MOLDED



**32-807404**

Seawater pump to oil cooler  
1-1/4 in. (32 mm) I.D.  
Fits MCM/MIE V-8 (454 & 502 cid) engines

## HOSE - MOLDED



**32-821417**

Seawater pump to oil cooler  
1-1/4 in. (32 mm) I.D.  
Fits 7.4L & 8.2L MIE

## HOSE - MOLDED



**32-808044**

Seawater pump to oil cooler  
1-1/4 in. (32 mm) I.D.  
Fits MCM/MIE GM V-8 (454 & 502 cid) engines

## HOSE - MOLDED



**32-821418**

Seawater pump to oil cooler  
1-1/4 in. (32 mm) I.D.  
Fits 454 Mag

## HOSE - MOLDED



**32-816197**

Seawater pump to oil cooler  
1-1/4 in. (32 mm) I.D.  
Fits 465 & 500 Bulldog

## HOSE - MOLDED



**32-848178**

Seawater pump to oil cooler  
1-1/4 in. (32 mm) I.D.  
Fits 450, 500, 525 & 600 SC

## HOSE - MOLDED



**32-818741**

Seawater pump to oil cooler  
1-1/4 in. (32 mm) I.D.  
Fits 7.4L Bravo

## HOSE - MOLDED



**32-849604**

Seawater pump to oil cooler  
1-1/4 in. (32 mm) I.D.  
Fits 500

**HOSE - MOLDED**



**32-849935**

Seawater pump to fuel cooler  
1-1/4 in. (32 mm) I.D.  
Fits 500 EFI & 575 SCi

**HOSE - MOLDED**



**32-856706**

Seawater pump to oil cooler  
1-1/4 in. (32 mm) I.D.  
Fits 454 Mag

**HOSE - MOLDED**



**32- 12817**

Oil cooler to oil cooler  
1-1/4 in. (32 mm) I.D.  
Fits 370, 420, 425, 500 & 575

**HOSE - MOLDED**



**32- 63829**

Oil cooler to oil cooler  
1-1/4 in. (32 mm) I.D.  
Fits 330/340/7.4L MIE

**HOSE - MOLDED**



**32-807405**

Oil cooler to oil cooler  
1-1/4 in. (32 mm) I.D.  
Fits 7.4L/8.2L MPI MIE, 454 Mag & 502 Mag

**HOSE - MOLDED**



**32-807406**

Oil cooler to oil cooler, 1-1/4 in. (32 mm) I.D.  
Use with 13 in. long engine oil cooler  
Fits 7.4L & 8.2L MPI MIE, 454 Mag & 502 Mag with VST fuel system

**HOSE - MOLDED**



**32-807406 1**

Fuel cooler to oil cooler, 1-1/4 in. (32 mm) I.D.  
Use with 13 in. long engine oil cooler  
Fits 7.4L & 8.2L MPI MIE, 454 Mag & 502 Mag with fuel cooled system

**HOSE - MOLDED**



**32-807989**

NLA - Order 32-71613  
Fuel cooler to oil cooler, 1-1/4 in. (32 mm) I.D.  
Use with 10 in. long oil cooler  
Fits 7.4L & 8.2L MPI MIE, 454 Mag & 502 Mag

## HOSE - MOLDED



**32-814749**

Oil cooler to oil cooler  
1-1/4 in. (32 mm) I.D.  
Fits 7.4L MIE

## HOSE - MOLDED



**32-897142**

Cooler to thermostat housing  
1-1/4 in. (32 mm) I.D.  
Fits 7.4L

## HOSE - MOLDED



**32-816504**

Oil cooler to oil cooler  
1-1/4 in. (32 mm) I.D.  
Fits 525SC, 600SC & 800SC

## HOSE - MOLDED



**32-896999**

Cooler to thermostat housing  
1-1/4 in. (32 mm) I.D.  
Fits 7.4L

## HOSE - MOLDED



**32-844881**

Fuel cooler to oil cooler  
1-1/4 in. (32 mm) I.D.  
Fits 500 EFI & 575 SCi

## HOSE - MOLDED



**32-896998**

Cooler to thermostat housing  
1-1/4 in. (32 mm) I.D.  
Fits MCM/MIE GM V-8 (427, 454 & 502 cid) engines

## HOSE - MOLDED



**32-848956**

Oil cooler to oil cooler  
1-1/4 in. (32 mm) I.D.  
Fits 450, 465, 500, 525 SC, 575 SCi & 600 SC

## HOSE - MOLDED



**32-805469**

Cooler to thermostat housing  
1-1/4 in. (32 mm) I.D.  
Fits 502 EFI (Gen V)

HOSE - MOLDED



**32-807407**

Cooler to thermostat housing  
1-1/4 in. (32 mm) I.D.  
Fits 7.4L & 8.2L MIE and 454 & 502 Mag

HOSE - MOLDED



**32-807407 1**

NLA - Order 32-807407  
Cooler to thermostat housing  
1-1/4 in. (32 mm) I.D.  
Fits 7.4L/LX and 454 Mag

HOSE - MOLDED



**32-807407 3**

Cooler to thermostat housing  
1-1/4 in. (32 mm) I.D.  
Fits 7.4L MPI MCM/MIE & 8.2L MPI MIE

HOSE - MOLDED



**32-844475**

Cooler to thermostat housing  
1-1/4 in. (32 mm) I.D.  
Fits 575 SCi

HOSE - MOLDED



**32-844882 1**

Cooler to thermostat housing  
1-1/4 in. (32 mm) I.D.  
Fits 377 Scorpion Sterndrive & 500 EFI

HOSE - MOLDED



**32- 89730 1**

Thermostat housing to starboard exhaust manifold  
1 in. (25 mm) I.D. at one end; 13/16 in. (21 mm) I.D. at other end of hose  
Fits MCM/MIE V-8 (454 & 502 cid) engines

HOSE - MOLDED



**32-807201**

Thermostat housing to starboard exhaust manifold  
1 in. (25 mm) I.D. at ends of hose  
Fits 7.4L & 8.2L MIE and 454 & 502 Mag

HOSE - MOLDED



**32-848954**

Thermostat housing to starboard exhaust manifold  
1 in. (25 mm) I.D. at ends of hose  
Fits 500 & 500 Bulldog

**HOSE - MOLDED**



**32-849939**

Thermostat housing to starboard exhaust manifold  
1 in. (25 mm) I.D.  
Fits 500 EFI

**HOSE - MOLDED**



**32-89749 1**

Thermostat housing to port exhaust manifold  
1 in. (25 mm) I.D. at one end; 13/16 in. (21 mm) I.D. at other end of hose  
Fits MCM/MIE GM V-8 (454 & 502 cid) engines

**HOSE - MOLDED**



**32-849943**

Thermostat housing to starboard exhaust manifold  
1 in. (25 mm) I.D.  
Fits 575 SCi

**HOSE - MOLDED**



**32-97385 2**

Thermostat housing to port exhaust manifold  
1 in. (25 mm) I.D. at ends of hose  
Fits 340/7.4L & 8.2L MIE

**HOSE - MOLDED**



**32-848957**

Thermostat housing to starboard exhaust manifold  
1 in. (25 mm) I.D. at ends of hose  
Fits 525 SC

**HOSE - MOLDED**



**32-97385 3**

Thermostat housing to port exhaust manifold  
1 in. (25 mm) I.D. at ends of hose  
Fits 7.4L & 8.2L MIE

**HOSE - MOLDED**



**32-861318**

Thermostat housing to starboard exhaust manifold  
1 in. (25 mm) I.D. at ends of hose  
Fits 7.4L & 8.2L MIE and 454 & 502 Mag

**HOSE - MOLDED**



**32-816347**

Thermostat housing to port exhaust manifold  
1 in. (25 mm) I.D. at ends of hose  
Fits 525SC



HOSE - MOLDED



**32-848955**

Thermostat housing to port exhaust manifold  
1 in. (25 mm) I.D. at ends of hose  
Fits 500 & 500 Bulldog

HOSE - MOLDED



**32-849936**

Thermostat housing to port exhaust elbow  
1 in. (25 mm) I.D.  
Fits 500 EFI

HOSE - MOLDED



**32-849938**

Thermostat housing to port exhaust manifold  
1 in. (25 mm) I.D.  
Fits 500 EFI

HOSE - MOLDED



**32-849940**

Thermostat housing to port exhaust elbow  
1 in. (25 mm) I.D.  
Fits 575 SCi

HOSE - MOLDED



**32-849937**

Thermostat housing to starboard exhaust elbow  
1 in. (25 mm) I.D.  
Fits 500 EFI

HOSE



**32- 13556A 1**

Transom to seawater pump  
1-1/4 in. (32 mm) I.D. x 10 ft. (3.05 m) length  
Fits 377 Scorpion (Sterndrive)

HOSE - MOLDED



**32-849941**

Thermostat housing to starboard exhaust elbow  
1 in. (25 mm) I.D.  
Fits 575 SCi

HOSE



**32-8M0062666**

Transom to seawater pump (Red color)  
1-1/4 in. (32 mm) I.D. x 8 ft. (2.44 m) length  
Fits MCM/MIE GM V-6 and V-8 (305, 350, 377, 454, 502, 540 & 572 cid) engines

## HOSE



**32-8M0062614**

1 in. (25 mm) I.D. x 48 in. (1219 mm) length  
Thermostat housing to exhaust manifolds and elbows

## HOSE



**32- 47642**

Transom to thermostat housing  
5/8 in. (16 mm) I.D. x 49 in. (1244 mm) length  
Fits 120, 140, 160, 165 (6 cyl.) & 888

## HOSE



**32-8M0062634**

Transom to thermostat housing  
3/4 in. (19 mm) I.D. x 44 in. (1118 mm) length  
Fits MCM 120/2.5L and 140/3.0L/LX

## HOSE



**32-8M0062665**

Seawater pump to oil cooler (Red color)  
1-1/4 in. (32 mm) I.D. x 48 in. (1219 mm) length  
Fits MIE Ford V-8 (302 & 351 cid) engines  
Fits MCM/MIE GM V-8 (327, 350, 454 & 572 cid) engines

## HOSE



**32-866331**

Seawater pump to oil cooler  
1-1/4 in. (32 mm) I.D. x 8 in. (203 mm) length  
Fits MIE Tow Sports 350 cid engines

## HOSE - BELL HOUSING



**32- 32461**

5/8 in. (16 mm) I.D. x 13-3/4 in. (349 mm) length  
Fits MC-I, R, MR & Alpha One

## HOSE - BELL HOUSING



**32-8M0062309**

3/4 in. (19 mm) I.D. x 14 in. (356 mm) length  
Fits MR, Alpha One & Gen II

## HOSE - BELL HOUSING



**32- 43437**

NLA - Order 32-8M0090859  
Fits Bravo transom

**OIL COOLERS**

**OIL COOLER**



**47610A15**

Engine and/or Transmission,  
Flywheel housing mounted cooler  
Fits MCM Hi-Perf GM V-8 engines.

**OIL COOLER**



**63831A 3**

Engine  
7.88 in. (200 mm) overall length, 1.25 in. (32 mm) O.D. hose fittings  
Fits MCM/MIE GM V-8 427/454 cid engines.

**OIL COOLER**



**63832A 1**

Transmission and/or power steering  
11.88 in. (302 mm) overall length, 1.25 in. (32 mm) O.D. hose fittings  
Fits MCM/MIE Ford & GM V-8 engines.

**OIL COOLER**



**63832T**

Transmission  
14.88 in. (378 mm) overall length, 1.25 in. (32 mm) O.D. hose fittings  
Fits MCM/MIE Ford & GM V-8 engines.

**OIL COOLER**



**70886T 2**

Engine  
19.00 in. (483 mm) overall length, 1 in. (25 mm) NPT internal threaded hose fittings  
Fits MCM Hi-Perf GM V-8 454/540 cid engines.

**OIL COOLER**



**85152T**

Engine and Power Steering  
16.63 in. (422 mm) overall length, 1.25 in. (32 mm) O.D. hose fittings  
Fits MCM GM V-8 454 cid engines.

**OIL COOLER**



**89690T**

Engine and Power Steering  
11.63 in. (295 mm) overall length, 1.25 in. (32 mm) O.D. hose fittings  
Fits MCM GM V-8 350 & 454 cid engines.

**OIL COOLER**



**99356A 1**

Power Steering  
7.87 in. (200 mm) overall length, 1.00 in. (25 mm) O.D. hose fittings  
Fits MCM in-line 4 cyl. engines.

## OIL COOLER



### 99356A 2

Power Steering  
7.87 in. (200 mm) overall length, 1.25 in. (32 mm) O.D. hose fittings  
Fits MCM GM V-6 & V-8 engines

## OIL COOLER



### 805561T

Engine and Power Steering  
19.62 in. (498 mm) overall length, 1.25 in. (32 mm) O.D. hose fittings,  
P/S hose connectors offset from water hose connectors  
Fits MCM 502 EFI (Gen V) (s/n 0D840650-0F114528)

## OIL COOLER



### 805561T 1

Engine and Power Steering  
19.62 in. (498 mm) overall length, 1.25 in. (32 mm) O.D. hose fittings,  
P/S hose connectors directly in-line with water hose connectors  
Fits MCM 502 EFI (Gen V) (s/n 0F114529-0F802599)

## OIL COOLER



### 806423T

NLA, Engine and Power Steering  
16.63 in. (422 mm) overall length, 1.25 in. (32 mm) O.D. hose fittings  
Fits MCM 454 EFI (Gen V) (s/n 0F115700-0F802349) &  
MCM 454 Mag Bravo (Gen V) (s/n 0F114760-0F801699)

## OIL COOLER



### 806426T

Engine  
7.88 in. (200 mm) overall length, 1.25 in. (32 mm) O.D. hose fittings  
Fits MIE 7.4L (Gen V & VI) (s/n 0F160000-0K999999).

## OIL COOLER



### 806428T

Engine and Power Steering  
11.63 in. (295 mm) overall length, 1.25 in. (32 mm) O.D. hose fittings  
Fits MCM 7.4L Bravo (Gen V) (s/n 0F114760-0F800699).

## OIL COOLER



### 807371T

Engine,  
9.75 in. (248 mm) overall length, 1.25 in. (32 mm) O.D. hose fittings and in-line oil  
hose connections  
Fits MCM/MIE GM V-8 454/502 cid engines (Gen VI).

## OIL COOLER



### 807371T 1

Engine,  
10 in. (254 mm) overall length, 1.25 in. (32 mm) O.D. hose fittings and off-set oil  
hose connections  
Fits MCM/MIE GM V-8 454/502 cid engines (Gen VI).

**OIL COOLER**



**807372T**

Engine,  
13.50 in. (343 mm) overall length, 1.25 in. (32 mm) O.D. hose fittings  
Fits MCM/MIE GM V-8 454/502 cid engines (Gen VI).

**OIL COOLER**



**808029T**

Transmission  
8.75 in. (222 mm) overall length, 1.25 in. (32 mm) O.D. hose fittings  
Fits MIE GM V-8 350/377 cid Tow Sports engines

**OIL COOLER**



**816074T**

Engine  
21 in. (533 mm) overall length, 1.25 in. (32 mm) O.D. hose fittings  
Fits MCM Hi-Perf GM V-8 454/502/540 cid engines.

**OIL COOLER**



**816482T**

Engine  
21 in. (533 mm) overall length, 1.25 in. (32 mm) O.D. hose fittings  
Fits MCM Hi-Perf GM V-8 454/502/540/572 cid engines.

**OIL COOLER**



**848192T**

Engine  
16.75 in. (425 mm) overall length, 1.25 in. (32 mm) O.D. hose fittings  
Fits MCM Hi-Perf GM V-8 454/502 cid engines.

**OIL COOLER**



**849115T01**

Power Steering & Transmission  
15.38 in. (391 mm) overall length, 1.25 in. (32 mm) O.D. hose fittings  
Fits MCM Hi-Perf 900 SC engines.

**OIL COOLER**



**849291**

Power Steering  
10.30 in. (262 mm) overall length, 1.25 in. (32 mm) O.D. hose fittings  
Fits MCM Hi-Perf V-8 502/540/572 cid engines.

**OIL COOLER**



**849952A03**

Engine  
19.50 in. (495 mm) overall length, 1.25 in. (32 mm) O.D. hose fittings  
Fits MCM Hi-Perf 500 EFI, 525 EFI and 575 SCi

# MERCURY® MERCRUISER® COOLING SYSTEM

## OIL COOLER



### 861554T01

Power Steering  
11.50 in. (292 mm) overall length, 1.25 in. (32 mm) O.D. hose fittings  
Fits MCM GM in-line 4 cyl., V-6 & V-8 engines.

## OIL COOLER



### 861946T

Engine  
11.06 in. (281 mm) overall length, 1.25 in. (32 mm) O.D. hose fittings  
Fits MCM 496 Mag & HO (s/n 0M025000-0M095324) and MIE 8.1S & HO (s/n 0M026000-0M027850)

## OIL COOLER



### 862837T

Transmission  
16.62 in. (422 mm) overall length, 1.25 in. (32 mm) O.D. hose fittings  
Fits MIE GM V-8 350 & 454/502 cid engines.

## OIL COOLER



### 863820T 1

Power Steering  
11.50 in. (292 mm) overall length, 1.25 in. (32 mm) O.D. hose fittings  
Fits MCM 4.3L, 5.0L, 5.7L & 6.2L MPI engines(s/n 0M300000 and up)

## OIL COOLER



### 863832T01

Transmission  
17 in. (431 mm) overall length, 1.25 in. (32 mm) O.D. hose fittings  
Fits MIE & Tow Sports 350 Mag MPI & MX 6.2L MPI (s/n 0M300000 and up)

## OIL COOLER



### 863842T02

Transmission  
9.74 in. (247 mm) overall length, 1.25 in. (32 mm) O.D. hose fittings  
Fits MIE & Tow Sports 350 Mag MPI & MX 6.2L MPI (s/n 0M313035 and up)

## OIL COOLER



### 863904T

Engine  
8.97 in. (228 mm) overall length, 1.25 in. (32 mm) O.D. hose fittings and one 3/4 in. (19 mm) hose fitting.  
Fits MCM 496 Mag & HO (s/n 0M095325 and up) and MIE 8.1S & HO (s/n 0M027851 and up)

**OIL COOLER**



**879194T52**

Power Steering - Axis  
13 in. (330 mm) overall length, 1.25 in. (32 mm) O.D. hose fittings

Fits MCM V-8 MPI engines with Axis steering

**OIL COOLER**



**8M0045696**

Engine  
13.50 in. (343 mm) overall length, 1.25 in. (32 mm) O.D. hose fittings.  
Fits MCM 8.2L Mag & HO and MIE 8.2L & HO EC

**OIL COOLER**



**879194T60**

Transmission  
13 in. (330 mm) overall length, 1.25 in. (32 mm) O.D. hose fittings  
Fits Tow Sports 350 Mag MPI & MX 6.2L MPI (s/n 0M391600 and up) with B/W 45C transmission

**OIL COOLER**



**879288T46**

Engine  
9 in. (229 mm) overall length, 1.25 in. (32 mm) O.D. hose fittings. fitting.  
Fits MCM 496 Mag & HO EC and MIE 8.1S & HO EC

**MERCURY® MERCRUISER® EXHAUST SYSTEM**

**EXHAUST WATER SHUTTERS**

**WATER SHUTTER**

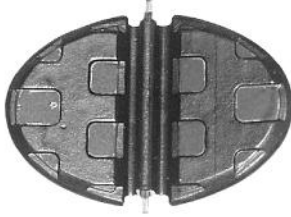

**60930**

**WATER SHUTTER**



**99370A 2**

**WATER SHUTTER**



**807166A 1**

2.48 in. diameter at cross pin

**WATER SHUTTER**



**807166A 2**

2.98 in. diameter at cross pin

**WATER SHUTTER**



**807166A 3**

2.50 in. diameter at cross pin

This kit is designed to replace both of the offset plate water shutters p/n 14348A1.



MERCURY® MERCUISER® EXTERNAL ENGINE

V-BELTS

V-BELT



<b>57- 57298Q</b>
28 in. (711 mm) length
<b>57- 13457Q</b>
29 in. (737 mm) length
<b>57- 74270Q</b>
31-1/2 in. (800 mm) length
<b>57- 94290Q</b>
32-3/8 in. (822 mm) length
<b>57- 74271Q</b>
35-1/8 in. (892 mm) length
<b>57- 65607Q</b>
37 in. (940 mm) length
<b>57-862054Q</b>
39-1/2 in. (1003 mm) length
<b>57- 69143Q</b>
40 in. (1016 mm) length
<b>57- 64032Q 1</b>
41 in. (1041 mm) length
<b>57- 93658Q</b>
44 in. (1118 mm) length
<b>57- 44207Q</b>
44-5/8 in. (1133 mm) length
<b>57- 48120Q 1</b>
46 in. (1168 mm) length
<b>57- 78200Q 1</b>
47 in. (1194 mm) length
<b>57- 14458Q</b>
48 in. (1219 mm) length
<b>57- 48122Q</b>
48 in. (1219 mm) length
<b>57-816034Q</b>
48-1/8 in. (1222 mm) length
<b>57- 96834Q</b>
50 in. (1270 mm) length
<b>57-821023Q</b>
51-5/8 in. (1313 mm) length
<b>57- 37619Q</b>
52 in. (1321 mm) length
<b>57-816295Q</b>
52-1/2 in. (1333 mm) length
<b>57- 13458Q</b>
55 in. (1397 mm) length
<b>57-812427Q</b>
56 in. (1422 mm) length

SERPENTINE BELTS

SERPENTINE BELT

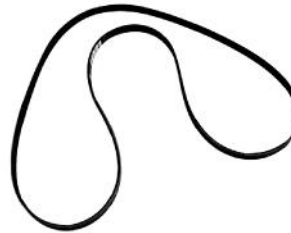

<b>57-865615Q09</b>
1780 mm length
Fits 1999-2001 MCM V-6 & V-8 (305 & 350 cid) Alpha engines with high mounted alternator (s/n 0L619000-0M320024)
<b>57-8M0028573</b>
1808 mm length
Fits MCM 100 Vazer
<b>57-807755Q05</b>
1930 mm length
<b>57-865615Q04</b>
1941 mm length
Fits 2001 and newer MCM V-6 & V-8 (305 & 350 cid) Alpha engines with standard cooling (s/n 0M320025 and above)
<b>57-8M2018590</b>
2086 mm
Fits 2011 MCM 4.3L MPI EC Alpha engines with standard cooling
<b>57-865635Q02</b>
2111 mm length
Fits 2005 and newer MIE 8.1S engines (s/n 0W390000 and up). Also fits 2005 & newer MCM 496 Mag engines (s/n 0W310000 and up) that the power steering pump has been removed.
<b>57-865615Q10</b>
2195 mm length
Fits 2001 and newer MIE engines with closed cooling and the 4-1/4 in. idler pulley
<b>57-861758Q</b>
2197 mm length
<b>57-865615Q05</b>
2233 mm length
Fits 2001 and newer MIE & Tow Sports engines with standard cooling and the 4-1/4 in. idler pulley
<b>57-807755Q04</b>
2240 mm length
<b>57-865615Q12</b>
2266 mm length
<b>57-865615Q02</b>
2285 mm length
Fits 2001-2004 MIE 8.1S engines (s/n 0M025000-0W389999). Also fits 2001-2005 MCM 496 Mag engines (s/n 0M025000-0W309999) that the power steering pump has been removed.
<b>57-8M0045986</b>
2287 mm
Fits 2010 & newer MIE 8.2L & HO EC engines
<b>57-861759Q</b>
2352 mm length
<b>57-865615Q07</b>
2467 mm length
Fits 1998-2001 MCM V-8 (454 & 502 cid) Bravo engines with serpentine belt that the power steering pump is being removed.

## 57-861757Q

2471 mm length

## 57-865635Q01

2519 mm length

Fits MCM 496 Mag (s/n 0W310000 and up)

## 57-865615Q08

2535 mm length

Fits 1999-2002 MCM V-6 & V-8 (305, 350 & 377 cid) Bravo engines with high mounted alternator that the power steering pump is being removed (s/n 0L619000-0M343007).

## 57-865615Q11

2638 mm length

## 57-861049Q

2649 mm length

## 57-865615Q06

2667 mm length

## 57-865615Q03

2704 mm length

Fits 2001 and newer MCM V-6 & V-8 (305, 350 & 377 cid) Alpha engines with closed cooling and Bravo engines with standard cooling (s/n 0M320025 and above)

## 57-879288Q20

2732 mm

Fits MCM 496 Mag & HO with Axius steering (s/n 1A349534 & below), also MCM 4.3L MPI EC engine with closed cooling

## 57-8M2018984

2782 mm

Fits 2011 MCM 4.3L MPI EC Bravo engines with standard cooling; also fits 2008 & newer MCM V-8 (305, 350 & 377 cid) engines w/ Axius steering

## 57-865615Q01

2830 mm length

Fits MCM 496 Mag (s/n 0M025000-0W309999)

## 57-879288Q21

2910 mm

Fits MCM 496 Mag & HO with Axius steering (s/n 1A349535 and up)

## 57-8M0045227

3157 mm

Fits 2010 & newer MCM 8.2L Mag & HO EC engines

## SERPENTINE BELT KIT

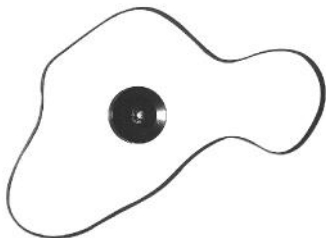

## 57-861758A 1

2197 mm length belt & pulley

## 57-861759A 1

2352 mm length belt & pulley

## 57-861757A 1

2471 mm length belt & pulley

## 57-861049A 2

2649 mm length belt & pulley

## 57-861049A 1

2667 mm length belt & pulley

## ENGINE COUPLERS

### ENGINE COUPLER



## 18643A09

Fits MCM 1.6L Vazer

### ENGINE COUPLER



## 76850A 2

Crankshaft stud mount

Fits MCM GM in-line engines, V-6 and V-8 (283, 305 & 350 cid) engines

### ENGINE COUPLER



## 12632A 7

Triangular shape, flywheel mount

Fits MCM 120/2.5L & 140/3.0L (1987-1993)

### ENGINE COUPLER



## 12632A 6

Triangular shape, flywheel mount

Fits MCM 3.0L/LX (1994-1998)

**ENGINE COUPLER**



**69354A 2**

Crankshaft stud mount  
Fits MCM 470 & 485

**ENGINE COUPLER**



**97432A 2**

Flywheel mount  
Fits MCM 3.7L engines (1983-1989)

**ENGINE COUPLER**



**18643A 5**

Triangular shape, flywheel mount  
Fits MCM 3.0L (1999 & newer), GM V-6 & V-8 (305 & 350 cid) engines (1993 and newer)

**ENGINE COUPLER**



**18643A 7**

Triangular shape, flywheel mount  
Fits MCM GM V-6 & V-8 (305 & 350 cid) engines (1983-1993) & 454 Mag Alpha

**ENGINE COUPLER**



**861523A 9**

Round shape, flywheel mount  
Fits MCM GM V-8 engines with Bravo drive

**ENGINE COUPLER**



**861523A 7**

Round shape, flywheel mount  
Fits MCM 496 Mag & HO engines; also 8.2L Mag & HO

**861523A11**

Use with metric or SAE attaching screws  
Steel splines for low speed/work applications  
Fits MCM GM V-8 engines with Bravo drives

**ENGINE DRIVE PLATE**



**47608A 1**

Triangular shape  
Fits MIE 215, 225, 233 & 255 Ford;  
MIE & Tow Sports GM V-8 (305, 327 & 350 cid) engines

**ENGINE DRIVE PLATE**



**862975A 1**

Fits MIE 350 Mag, 454 Mag Horizon, 7.4L MPI & 8.2L MPI

**862975A 2**

Fits MIE 8.1L MPI

**ENGINE DRIVE PLATE**



**860125T**

Fits MIE & Tow Sports GM V-8 engines

**ENGINE DRIVE PLATE**



**8M0051206**

Fits MCM 460 TRS, 575, 600 SC & 800 SC

**MERCURY® MERCUISER® INTERNAL ENGINE**

**OIL PUMPS**

**OIL PUMP**



**36405**

w/o pick-up tube  
Fits MCM 120/2.5L, 140/3.0L/LX, & 160/165 (6 cyl)

**OIL PUMP**



**13838A 1**

Cast Iron  
Fits MCM 3.7L engines

**OIL PUMP**



**17617**

w/o pickup tube, 5/8" I.D. Pipe Hole  
Fits MCM/MIE GM V-6 & V-8 (283, 305, 327 & 350 cid) engines (1995 & older)

**OIL PUMP**



**809907002**

w/o Pickup Tube (3/4 in. ID Pipe Hole)  
Fits MCM/MIE GM V-6 & V-8 (305 & 350 cid) engines (1996 & newer)

**OIL PUMP**



**808693A 1**

w/o Pickup Tube  
Fits MCM/MIE 325, 330, 350, 350, 370, 390, 400, 440, 454 Mag & 7.4L

**OIL PUMP**



**827643**

w/ Pickup Tube  
Fits MCM/MIE 330, 454 Mag, 465, 502 Mag, 600SC, 7.4L/LX & 8.2L

**OIL PUMP**



**8M0051418**

w/ Pickup Tube  
Fits 2010 and newer MCM/MIE 8.2L

**OIL PUMP**



**827589T 1**

w/ Pickup Tube  
Fits MCM 420, 425, 465, 500, 525SC & 600SC

**OIL PUMP**



**98337T**

w/ Pickup Tube  
Fits MCM 460 TRS

**PICK UP TUBE**



**13843A 2**

For the 13838A 1 oil pump  
Fits MCM 3.7L engines

**OIL PUMP**



**8M0069808**

w/ Pickup Tube  
Fits MCM 496 Mag & HO; also MIE 8.1S & HO

**PICK UP TUBE**



**809908 1**

3/4 in. OD Pipe  
Fits MCM 4.3L/LX/LH/LXH & 262 Mag (1996 & newer)

**OIL PUMP**



**98337T 6**

w/ Pickup Tube  
Fits MCM 500 Bulldog & 800SC

**PICK UP TUBE**



**809909**

3/4 in. OD Pipe  
Fits MCM/MIE GM V-8 (305 & 350 cid) engines (1996 & newer)

**OIL PUMP PICK-UP TUBES**

**PICK UP TUBE**



**52146**

Fits 120/2.5L & 140/3.0L/LX

**OIL PUMP PICKUP TUBE INSTALLATION TOOL**



**91-809929**

Use with 5/8 in. (16 mm) pick up tubes

**OIL PUMP PICKUP TUBE INSTALLATION TOOL**



**91-809938**

Use with 3/4 in. (19 mm) pick up tubes

**GASKET SETS - ENGINE OVERHAUL**

**OVERHAUL GASKET SET**



**27-801868**

4 pc. Oil Pan Gasket  
Fits MCM 120 (1964-1982)

**OVERHAUL GASKET SET**

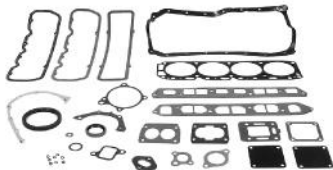

**27-810846A05**

1 pc. Oil Pan Gasket  
Fits MCM 3.0L/LX (1990 and newer)

**OVERHAUL GASKET SET**

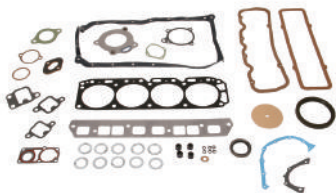

**27-810846A06**

Fits MCM 3.0L MPI (2008 and newer)

**OVERHAUL GASKET SET**

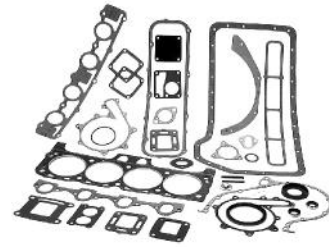

**27-74830A 3**

Fits MCM 470 & 485 (1976-1984)

**OVERHAUL GASKET SET**

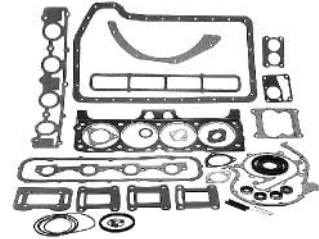

**27-43186A 1**

Fits MCM 3.7L engines (1983-1989)

**OVERHAUL GASKET SET**

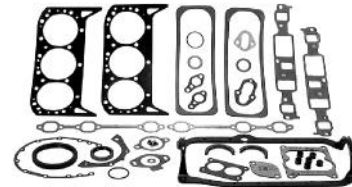

**27-11977A92**

Fits MCM 175, 185, 205, 4.3L/LX w/ 1 pc. rear main seal (1985-1993)

**OVERHAUL GASKET SET**

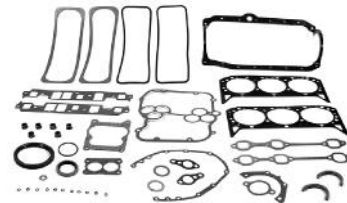

**27-824326A93**

Fits MCM 4.3L/LX Gen II (1993-1996)



## OVERHAUL GASKET SET

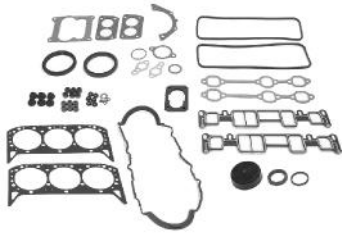

**27-824326A02**

Fits MCM 4.3L/LX/LH/LHX & 262 Mag (Gen+) (1A063239 and below)

## OVERHAUL GASKET SET

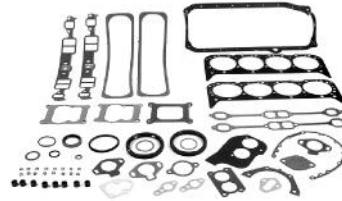

**27-75611A88**

Fits MCM/MIE 200, 230, 260, 350 Mag, 5.0L/LX & 5.7L (1987-1995)

## OVERHAUL GASKET SET

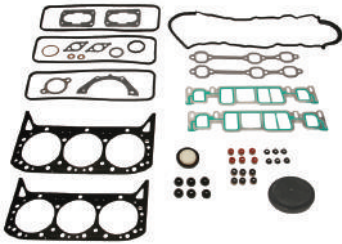

**27-824326A03**

Fits MCM 4.3L (s/n 1A063240 and up)

## OVERHAUL GASKET SET



**27-861246A05**

Fits MCM/MIE 5.0L & 5.7L (Gen+) (1998 and newer)

## OVERHAUL GASKET SET

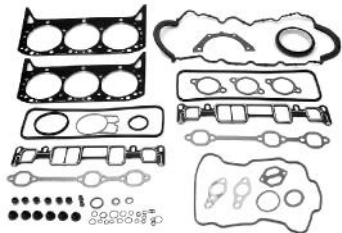

**27-807756A01**

Fits MCM 4.3L MPI (1A036239 and below)

## OVERHAUL GASKET SET

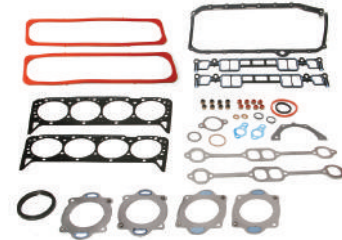

**27-861246A06**

Fits MCM/MIE 5.0L, 5.7L & 6.2L EC engines (2008 and newer)

## OVERHAUL GASKET SET

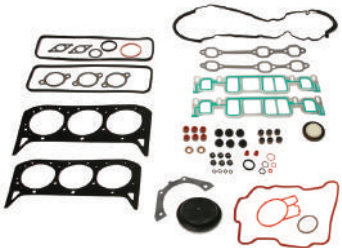

**27-807756A02**

Fits MCM 4.3L MPI (1A063240 and up)

## OVERHAUL GASKET SET



**27-806871A96**

Fits MCM/MIE 260, 350 Mag & 5.7L/LX (1991-1997)



**OVERHAUL GASKET SET**

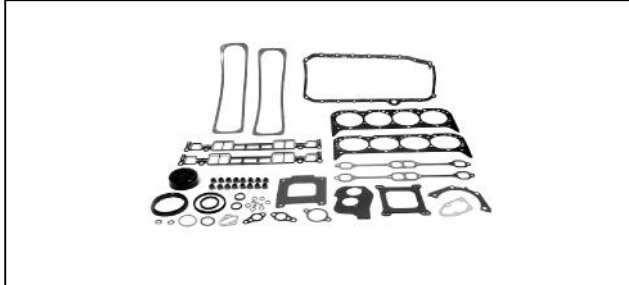

**27- 75611A96**

Fits MCM/MIE 5.7L/LX EFI & 350 Mag EFI (Gen+) (1996-1997)

**OVERHAUL GASKET SET**

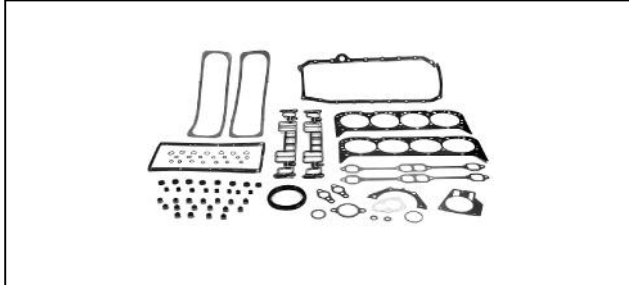

**27-807670A96**

Fits MCM 350 Mag MPI, Black Scorpion Tow Sports & 377 Scorpion Tow Sports (Gen+) (1996 and newer)

**OVERHAUL GASKET SET**

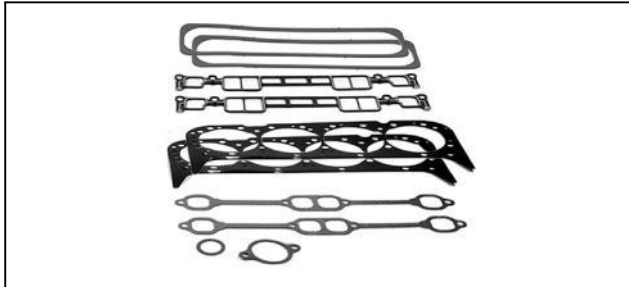

**27- 75611A98**

Fits MIE & Tow Sports 350 Mag MPI (Gen+) (1998 and newer)

**OVERHAUL GASKET SET**

Image not Available.

**27-861246A99**

Fits Tow Sports 5.7L EC engines (2008 and newer)

**OVERHAUL GASKET SET**

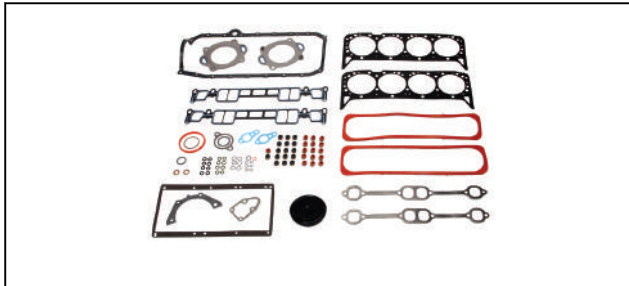

**27-807670A03**

Fits Tow Sports Scorpion 350 & 377 EC engines (2008 and newer)

**OVERHAUL GASKET SET**

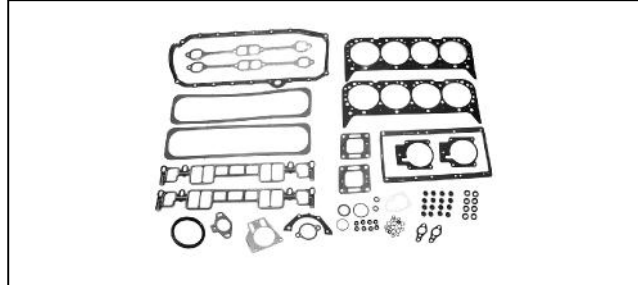

**27-807670A97**

Fits MCM 377 Scorpion

**OVERHAUL GASKET SET**

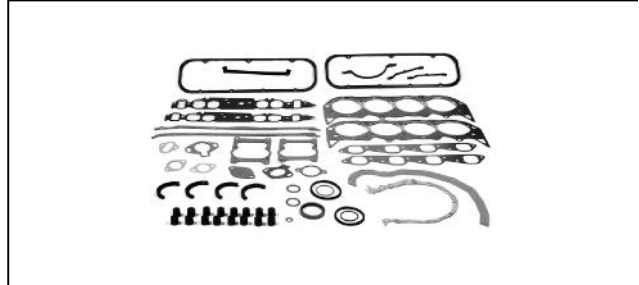

**27- 65184A88**

(RH or LH) Rotation  
Fits MCM/MIE 330, 340, 7.4L & 454 Mag Alpha (1977-1992)

**OVERHAUL GASKET SET**

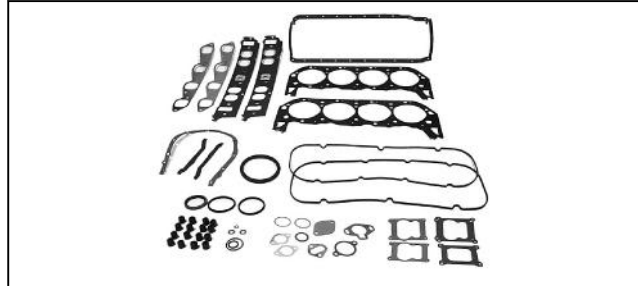

**27-811547A92**

Fits MCM 7.4L & 454 Mag (Gen V) (1992-1996)

**OVERHAUL GASKET SET**

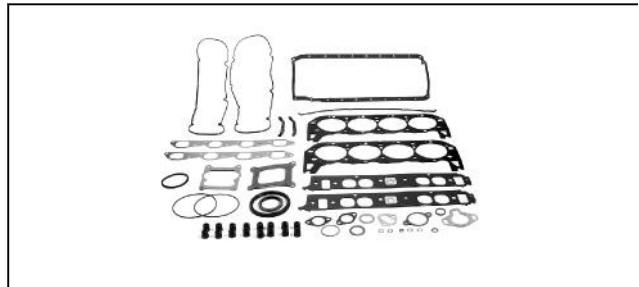

**27-850470A96**

Fits MCM/MIE 7.4L (Gen VI) (1996-1997)

## OVERHAUL GASKET SET

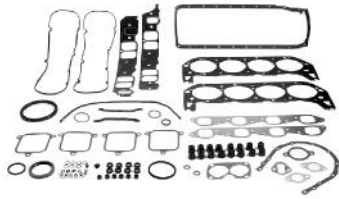

**27-805396A95**

Fits MCM/MIE 7.4L LX MPI (Gen V & VI) (1995-1997)

## OVERHAUL GASKET SET

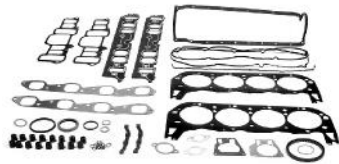

**27-802567A98**

Fits MCM/MIE 7.4L MPI (L29-Gen VI) (1998 and newer)

## GASKET SET



**27-811572A94**

Fits MCM 454 Mag (Gen VI) (1996 and newer)

## OVERHAUL GASKET SET

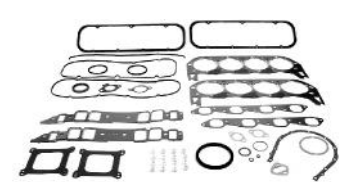

**27-818572A98**

Fits 454 EFI Tow Sports; MCM 450 & 500 (Gen V & VI) (1994-1997)

## OVERHAUL GASKET SET

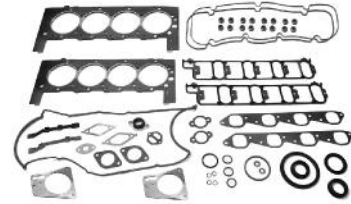

**27-889924A01**

Fits MCM 496 Mag & HO; also MIE 8.1S & HO

**27-889924A02**

Fits MCM 496 Mag & HO; also MIE 8.1S & HO

## OVERHAUL GASKET SET

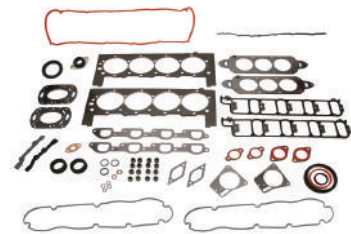

**27-889924A03**

Fits MCM 496 Mag & HO EC engines; also MIE 8.1S & HO EC engines

## OVERHAUL GASKET SET

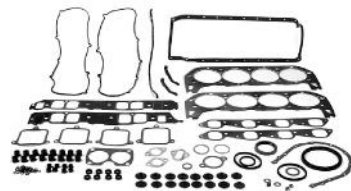

**27-805396A92**

Fits MCM 502 Mag MPI & MIE 8.2L MPI (Gen VI) (1996 and newer)

## OVERHAUL GASKET SET

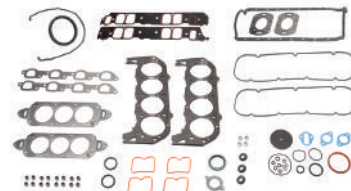

**27-8M0045578**

Fits 2010 and newer MCM/MIE 8.2L

**OVERHAUL GASKET SET**

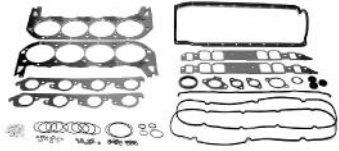

**27-842129A 1**

Fits MCM 500 EFI

**OVERHAUL GASKET SET**

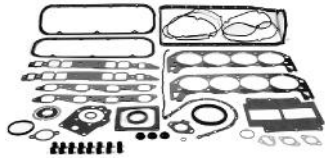

**27-827014A98**

Fits MCM 525SC (Gen V & VI) (1992-1997)

**OVERHAUL GASKET SET**

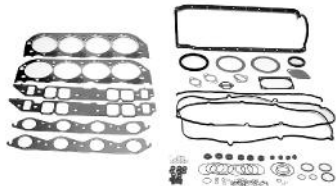

**27-843073A06**

Fits MCM 525 EFI

**OVERHAUL GASKET SET**

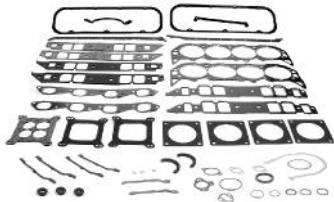

**27- 99386A96**

Fits MCM 500 Bulldog (1990 and newer)

**OVERHAUL GASKET SET**

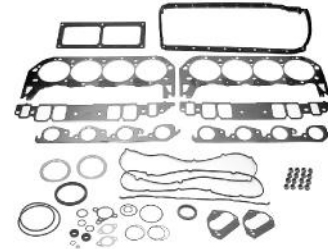

**27-842182A 1**

Fits MCM 575 SCi (2000-2001)

**WATER PUMP GASKET**

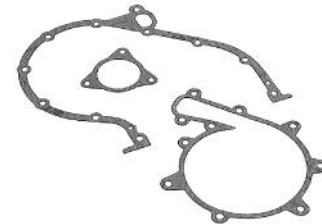

**27- 68714A 7**

Fits MCM 3.7L engines

**HEAD GASKETS**

**CYLINDER HEAD GASKET SET**

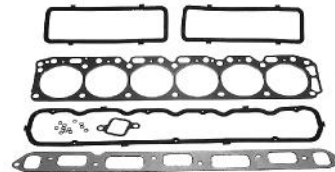

**27- 47453A 1**

Fits MCM GM in-line 6 cyl.

**CYLINDER HEAD GASKET SET**



**27- 75611A 2**

Fits MCM/MIE GM V-8 (305 & 350 cid) engines (1986 & older)

**CYLINDER HEAD GASKET SET**

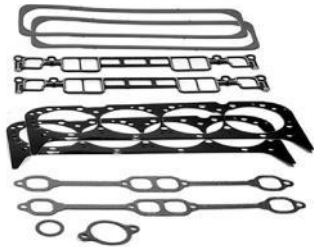

**27-75611A03**

Fits MCM/MIE GM V-8 (305, 350 & 377 cid) Gen + engines (1996 & newer)

MERCURY® MERCUISER® TRANSOM

**GIMBAL RING KITS**

**GIMBAL RING KIT**



**88302A 1**

Complete kit to convert the gimbal ring from a spline/splined upper shaft to a square/splined upper shaft. Also can be used to service a square gimbal ring with a splined steering arm.  
Fits MCM I drives (1978-1983)

**GIMBAL RING KIT**



**94993A12**

Fits R/MR/Alpha One drives (1983-1990)

**GIMBAL RING KIT**



**822374A 6**

Used to convert standard Bravo gimbal ring to heavy duty gimbal ring and bell housings. Trim limit switch cannot be used on HD gimbal ring.  
Fits MCM Bravo drives

**ENGINE MOUNTING HARDWARE**

**REAR ENGINE MOUNT BOLT KIT**



**10-97934A 1**

Fits R, MR, Alpha One, Gen II & Bravo drives

**REAR ENGINE MOUNT**



**865329A02**

Standard durometer  
Fits MCM flywheel housing with Alpha and Bravo drives

**REAR ENGINE MOUNT**



**865330A02**

Stiffer durometer for higher hp engines.  
Fits MCM flywheel housing with Bravo drive

**STERNDRIVE INSTALLATION HARDWARE**

**STERNDRIVE INSTALLATION HARDWARE**



**11-859116K01**

For mounting the MC-I, R, MR, Alpha & Bravo drives to the bell housing.  
Priced individually, sold @ multiples of 2  
Mercury Branded, Clamshell Package Point of Sale Packaged.

**11-859116Q01**

For mounting the MC-I, R, MR, Alpha & Bravo drives to the bell housing.  
Priced individually, sold @ multiples of 2  
Quicksilver Branded, Clamshell Package Point of Sale Packaged.

**SHIFT CABLE KITS**

**SHIFT CABLE KIT**

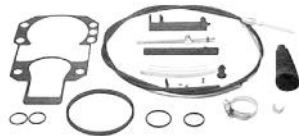

**865436A03**

Fits MC-I, R, MR, Alpha One & Gen II (1978 & newer)

**SHIFT CABLE KIT**



**815471T 1**

Fits Bravo

**SHIFT CABLES**

**SHIFT CABLE**



**73723A01**

Fits IA/IB/IC, EZ-Shift & MC-I (1977 & older)

**SHIFT CABLE**



**865436A02**

Fits MC-I, R, MR, Alpha One & Gen II (1978 & newer)

**SHIFT CABLE**



**33981A06**

Fits Vazer

**SHIFT CABLE**



**865437A02**

Fits Bravo

**DRIVE INSTALLATION GASKET KITS**

**DRIVE INSTALLATION KIT**



**27- 35996A 1**

Fits IA/IB/IC & EZ Shift (1964-1966)

**DRIVE INSTALLATION KIT**



**27- 64818T 4**

Fits MC-I drives (s/n 6225576 & below) (1967-1982)  
Mercury Branded, Peg Display Card Point of Sale Packaged.

**27- 64818Q 4**

Fits MC-I drives (s/n 6225576 & below) (1967-1982)  
Quicksilver Branded, Peg Display Card Point of Sale Packaged.

**DRIVE INSTALLATION KIT**



**27- 94996T 2**

Fits R, MR, Alpha One & Gen II drives (s/n 6225577 and above) (1983 & newer)  
Mercury Branded, Peg Display Card Point of Sale Packaged.

**27- 94996Q 2**

Fits R, MR, Alpha One & Gen II drives (s/n 6225577 and above) (1983 & newer)  
Quicksilver Branded, Peg Display Card Point of Sale Packaged.

**DRIVE INSTALLATION KIT**

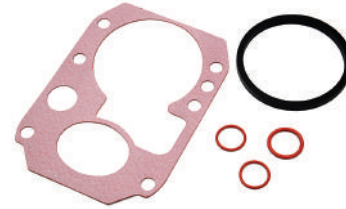

**27-866449A01**

Fits Vazer

**DRIVE INSTALLATION KIT**

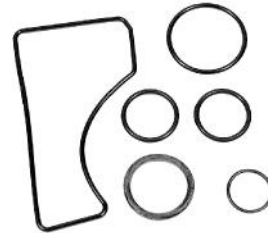

**16755T 1**

Fits Bravo drives.  
Priced individually, sold @ multiples of 2  
Mercury Branded, Clamshell Package Point of Sale Packaged.

**16755Q 1**

Fits Bravo drives.  
Priced individually, sold @ multiples of 2  
Quicksilver Branded, Clamshell Package Point of Sale Packaged.

**DRIVE INSTALLATION KIT**



**27- 54014Q 1**

Fits 215E, 215H, TR and TRS drives.  
Quicksilver Branded, Peg Display Card Point of Sale Packaged.



## TRANSOM SEAL REPAIR KITS

### TRANSOM SEAL REPAIR KIT



**30-803097T 1**

Fits R, MR & Alpha One w/ exhaust bellows

### TRANSOM SEAL REPAIR KIT



**30-803098T 1**

Fits R, MR & Alpha One w/ exhaust tube

### TRANSOM SEAL REPAIR KIT



**30-803099T 1**

Fits Alpha One Gen II

## TRANSOM SEAL REPAIR KIT



**8M0095485**

Fits Bravo & Blackhawk

## SHIFT CABLE BELLOWS

### SHIFT CABLE BELLOWS



**74639A 2**

Includes clamps

Fits all MCM sterndrives utilizing a drive unit shift cable. (1963 & newer)

**74639Q02**

Includes clamps

Fits all MCM sterndrives utilizing a drive unit shift cable. (1963 & newer)

Priced individually, sold @ multiples of 2

Quicksilver Branded, Clamshell Package Point of Sale Packaged.

## TRANSOM GASKET AND SEAL CHART

### Stern Drive Installation Gaskets

Model	Year Range	Serial # Range	Bell Housing Gasket Set	Bell Housing O-Ring	Bell Housing Rubber Seal	Transom Seal Repair Kit	Transom Seal/Gasket
60/80/90	1965 - 1966	1830753 - 2063740	N.L.A.	25- 22762	N.L.A.	N/A	N.L.A.
I	1963	1534570 - 1684187	N.L.A.	25- 33504	N/A	N/A	27- 70974
IA/IB/IC & EZ-Shift	1964 - 1966	1684188 - 2065186	27- 35996A 1	25- 33504	27- 35982	N/A	27- 70974
120/140	1967 - 1973	2062141 - 3780849	27- 64818Q 4	25- 33504	27- 35982	N/A	27- 70974
120/140	1974 - 1977	3780850 - 4893634	27- 64818Q 4	25- 33504	27- 35982	N/A	27- 65373
120/140	1978 - 1982	4893635 - 6225576	27- 64818Q 4	25- 33504	27- 35982	N/A	65533A 1
470/485	1976 - 1982	4208730 - 6225575	27- 64818Q 4	25- 33504	27- 35982	N/A	65533A 1
160/165	1967 - 1973	2065190 - 3780849	27- 64818Q 4	25- 33504	27- 35982	N/A	27- 70974
165	1974 - 1977	3780850 - 4890459	27- 64818Q 4	25- 33504	27- 35982	N/A	27- 65373
165	1978 - 1981	4890460 and up	27- 64818Q 4	25- 33504	27- 35982	N/A	65533A 1
888	1971 - 1977	3106717 and up	27- 64818Q 4	25- 33504	27- 35982	N/A	27- 65373(3)
888	1974 - 1977	3106717 and up	27- 64818Q 4	25- 33504	27- 35982	N/A	65533A 1(4)
225/233	1974 - 1977	3856268 and up	27- 64818Q 4	25- 33504	27- 35982	N/A	27- 65373(3)



Model	Year Range	Serial # Range	Bell Housing Gasket Set	Bell Housing O-Ring	Bell Housing Rubber Seal	Transom Seal Repair Kit	Transom Seal/Gasket
225/233	1974 - 1977	3856268 and up	27- 64818Q 4	25- 33504	27- 35982	N/A	65533A 1(4)
898/228	1977 - 1982	4782330 - 6225576	27- 64818Q 4	25- 33504	27- 35982	N/A	65533A 1
250/260	1977 - 1982	4791300 - 6225576	27- 64818Q 4	25- 33504	27- 35982	N/A	65533A 1
R, MR, Alpha One	1983 - 1990	6225577 - 0D469858	27- 94996Q 2	25- 33504	27- 35982	30-803097T 1(2)	65533A 1
R, MR, Alpha One	1983 - 1990	6225577 - 0D469858	27- 94996Q 2	25- 33504	27- 35982	30-803098T 1(1)	65533A 1
Alpha One SS	1986 - 1989	0A545004 and up	27- 94996Q 2	25- 33504	27- 35982	30-803097T 1(2)	65533A 1
Alpha One SS	1986 - 1989	0A545004 and up	27- 94996Q 2	25- 33504	27- 35982	30-803098T 1(1)	65533A 1
Alpha One Gen II	1991 - 2015	0D469859 and up	27- 94996Q 2	25- 33504	27- 35982	30-803099T 1	43713
Bravo I/II/III	1988 - 2015	0B664190 and up	16755Q 1	25- 45710 1	N/A	8M0095485	43713
Blackhawk	1994 - 1995	0F186717 and up	16755Q 1	25- 45710 1	N/A	8M0095485	43713
II	1962 - 1969	1474909 - 2671321	N/A	N/A	N/A	N/A	N.L.A.
III	1968 - 1972	2373127 - 3002613	N/A	25- 31534	N/A	N/A	27- 47366T
215E/H	1970 - 1972	2782203 - 2915034	27- 54014Q 1	N/A	N/A	N/A	27- 54395T
TR/TRS	1973 - 1993	3377316 and up	27- 54014Q 1	N/A	N/A	N/A	27- 54395T

- (1) With exhaust tube
- (2) With exhaust bellows
- (3) Gimbal ring without trim sender
- (4) Gimbal ring with trim sender

**MERCURY® MERCUISER® DRIVE SYSTEMS**

**U-JOINT AND COMPONENTS**

**CROSS & BEARING**



**75832T 1**

Fits IA/IB/IC & EZ, MC-I, R, MR, Alpha One & Gen II, Bravo (s/n 0M111207 and below) and MC II & TR/TRS

**CROSS & BEARING**



**805536A 2**

Fits Alpha One Gen II (s/n 0D870000-0M400411)

**CROSS & BEARING**



**865496A02**

Fits Alpha One Gen II (s/n 0M400412 and above), Bravo (s/n 0M111208 and above) and Vazer

**CROSS & BEARING**



**862132T**

NLA - Order complete U-joint Assembly 865425A03  
1.328 in. O.D. caps

Fits Bravo X/XR/XZ drives w/ the Meritor U-Joint assembly (s/n 0M750174 and below)

**CROSS & BEARING**



**866136A01**

1.218 in. O.D. caps

Fits Bravo X/XR/XZ drives w/ the GKN U-Joint assembly (s/n 0M750175 and above)

**CROSS & BEARING**



**8M0085593**

Fits III drive

**GEAR REPAIR KITS - DRIVESHAFT HOUSING**

**UPPER GEAR REPAIR KIT**



**43-803115T 1**

20-16 teeth, 1.32 ratio

Fits R, MR, Alpha One & SS (1983-1990)

**43-803116T 1**

22-20 teeth, 1.50 ratio

Fits R, MR, Alpha One & SS (1983-1990)

**43-803112T 1**

24-24 teeth, 1.65 ratio

Fits R, MR & Alpha One (1983-1990)

**43-803114T 1**

17-19 teeth, 1.84 ratio

Fits R, MR & Alpha One (1983-1990)

**43-803101T 1**

20-24 teeth, 1.98 ratio

Fits R, MR & Alpha One (1983-1990)

**UPPER GEAR REPAIR KIT**



**43-803102T 1**

22-20 teeth, 1.47 ratio  
Fits Alpha One Gen II (s/n 0D469856-0K999999) (1991-1997)

**43-803103T 1**

22-20 teeth, 1.47 ratio  
Fits Alpha One Gen II (s/n 0L100040 and above) (1998 & newer)

**43-803104T 1**

24-24 teeth, 1.62 & 2.00 ratio  
Fits Alpha One Gen II (s/n 0L100040 and above) (1998 & newer)

**43-803119T 1**

24-24 teeth, 1.62 ratio  
Fits Alpha One Gen II (s/n 0D469856-0K999999) (1991-1997)

**43-803105T 1**

17-19 teeth, 1.81 ratio  
Fits Alpha One Gen II (s/n 0L100040 and above) (1998 & newer)

**43-803120T 1**

17-19 teeth, 1.81 ratio  
Fits Alpha One Gen II (s/n 0D469856-0K999999) (1991-1997)

**43-803106T 1**

20-24 teeth, 1.94 & 2.40 ratio  
Fits Alpha One Gen II (s/n 0L100040 and above) (1998 & newer)

**43-803118T 1**

20-24 teeth, 1.94 & 2.40 ratio  
Fits Alpha One Gen II (s/n 0D469856-0K999999) (1991-1997)

**UPPER GEAR REPAIR KIT**



**43-803108T 2**

27-29 teeth  
Note: May require new replacement shims to be ordered separately, see MCM Service Bulletin 2001-17  
Fits Bravo I (1.36), II (1.50 & 1.81) & III (1.36 & 1.81) (s/n 0B664190-0L999999) (1988-1999)

**43-803107T 2**

27-32 teeth  
Note: May require new replacement shims to be ordered separately, see MCM Service Bulletin 2001-17  
Fits Bravo I (1.50), II (1.65 & 2.00) & III (1.50, 1.65 & 2.00) (s/n 0B664190-0L999999) (1988-1999)

**43-803109T 2**

23-30 teeth  
Note: May require new replacement shims to be ordered separately, see MCM Service Bulletin 2001-17  
Fits Bravo I (1.65), II (2.20) & III (2.20 & 2.43) (s/n 0B664190-0L999999) (1988-1999)

**GEAR SETS - DRIVESHAFT HOUSING**

**UPPER GEAR KIT**



**43- 45569A 5**

24-24 teeth, 1.68 ratio  
Fits 160 (1967-1969)

**UPPER GEAR KIT**



**43-8M0080756**

20-16 teeth, 1.32 ratio  
Fits MC-I, R, MR, Alpha One & SS (1975-1990)

**UPPER GEAR KIT**



**43- 18411A 4**

For use w/ heavy duty 1.50 gears only. The HD 1.50 drive gear has a stepped bearing surface requiring the use of a special bearing kit having 2 different I.D. bearings.  
Fits MR, Alpha One & SS (1984-1990)

**UPPER GEAR KIT**



**43- 18411A 2**

22-20 teeth, 1.50/1.47 ratio  
Fits MC-I, R, MR, Alpha One & Gen II (s/n 0K999999 and below) (1971-1997)

**UPPER GEAR KIT**



**43-45814A 5**

24-24 teeth, 1.65/1.62 ratio  
Fits MC-I, R, MR, Alpha One & Gen II (s/n 0K999999 and below) (1970-1997)

**UPPER GEAR KIT**



**43-75325A 3**

17-19 teeth, 1.84/1.81 ratio  
Fits MC-I, R, MR, Alpha One & Gen II (s/n 0K999999 and below) (1976-1997)

**UPPER GEAR KIT**



**43-55778A 3**

20-24 teeth, 1.98/1.94 & 2.40 ratio  
Fits MC-I, R, MR, Alpha One & Gen II (s/n 0K999999 and below) (1970-1997)

**UPPER GEAR KIT**



**43-853641A 2**

22-20 teeth, 1.47 ratio  
Fits Alpha One Gen II (s/n 0L000040 and above) (1998 & newer)

**UPPER GEAR KIT**



**43-853640A 2**

24-24 teeth, 1.62 & 2.00 ratio  
Fits Alpha One Gen II (s/n 0L000040 and above) (1998 & newer)

**UPPER GEAR KIT**



**43-853643A 2**

17-19 teeth, 1.81 ratio Alpha One Gen II;  
2.58 ratio Vazer  
Fits Alpha One Gen II (s/n 0L000040 and above) (1998 & newer) & Vazer drive

**UPPER GEAR KIT**



**43-853642A 2**

20-24 teeth, 1.94 & 2.40 ratio Alpha One Gen II;  
2.77 ratio Vazer  
Fits Alpha One Gen II (s/n 0L000040 and above) (1998 & newer) and Vazer drive

**UPPER GEAR KIT**



**43-883476A 4**

27-29 teeth  
Note: May require new replacement shims to be ordered separately, see MCM Service Bulletin 2001-17  
Fits Bravo I (1.36), II & III (1.81) (s/n 0B664190-0F729999) (1988-1995)

**43-883473A 4**

27-32 teeth  
 Note: May require new replacement shims to be ordered separately, see MCM Service Bulletin 2001-17  
 Fits Bravo I (1.50), II (2.00) & III (1.50, 1.65 & 2.00) (s/n 0B664190-0F729999) (1988-1995)

**43-883479A 4**

23-30 teeth  
 Note: May require new replacement shims to be ordered separately, see MCM Service Bulletin 2001-17  
 Fits Bravo I (1.65 ratio), II & III (2.20 ratio) (s/n 0B664190-0F729999) (1988-1995)

**UPPER GEAR KIT**



**43-883476A 3**

27-29 teeth, Gas & Diesel applications  
 Note: May require new replacement shims to be ordered separately, see MCM Service Bulletin 2001-17  
 Fits Bravo I & Perf. (1.36), II (1.50 & 1.81) & III (1.36 & 1.81) (s/n 0F730000-0M100000) (1996-1999)

**43-883473A 3**

27-32 teeth, Gas & Diesel applications  
 Note: May require new replacement shims to be ordered separately, see MCM Service Bulletin 2001-17  
 Fits Bravo I & Perf. (1.50), II (1.65 & 2.00) & III (1.50, 1.65 & 2.00) (s/n 0F730000-0M100000) (1996-1999)

**43-883479A 3**

23-30 teeth, Gas & Diesel applications  
 Note: May require new replacement shims to be ordered separately, see MCM Service Bulletin 2001-17  
 Fits Bravo I & Perf. (1.65), II (2.20) & III (2.20 & 2.43) (s/n 0F730000-0M100000) (1996-1999)

**UPPER GEAR KIT**



**43-883476A 2**

27/29 teeth, High bump  
 Fits Bravo I & Perf. (1.36), II (1.50 & 1.81) & III (1.36 & 1.81) (0M100001-0W249999). Also Bravo I (1.36), II (1.50) & III (1.36) 0W250000 and up

**43-883473A 2**

27/32 teeth, High bump  
 Fits Bravo I & Perf. (1.50), II (1.65 & 2.00) & III (1.50, 1.65 & 2.00) (0M100001-0W249999). Also Bravo III (1.50) (0W250000 and up)

**43-883479A 2**

23/30 teeth, High bump  
 Fits Bravo I & Perf. (1.65), II (2.20) & III (2.20 & 2.43) (0M100001-0W249999)

**43-8M0060003**

27/32 teeth, Low Bump  
 Fits Bravo I (1.50), II (1.65 & 2.00) & III (1.65 & 2.00) (0W250000 and up)

**43-8M0060004**

27/29 teeth, Low bump  
 Fits Bravo II (1.81) & III (1.81) (0W250000 and up)

**43-8M0060005**

23/30 teeth, Low bump  
 Fits Bravo I (1.65), II (2.20) & III (2.20 & 2.43) (0W250000 and up)

**UPPER GEAR KIT**



**43-887906A 1**

27/29 teeth  
 Fits Bravo I X & XZ (1.36), II X (1.50 & 1.81) & III X (1.36 & 1.81) (2000 & newer)

**43-887903A 1**

27/32 teeth  
 Fits Bravo I X & XZ (1.50), II X (1.65 & 2.00) & III X (1.50, 1.65 & 2.00) (2000 & newer)

**43-887909A 1**

23/30 teeth  
 Fits Bravo I X (1.65), II X (2.20) & III X (2.20 & 2.43) (2000 & newer)

**UPPER GEAR KIT**



**43-840898A 3**

19/16 teeth  
 Fits Bravo I XR (2000 & newer)

**GEARS - DRIVESHAFT HOUSING**

**UPPER DRIVEN GEAR**



**43- 62879T 1**

32 teeth  
 Fits TR/TRS

# MERCURY® MERCRUISER® DRIVE SYSTEMS

## UPPER DRIVE GEAR



**43- 62878**

24 teeth  
Fits TR/TRS

## GEAR CHART - DRIVESHAFT HOUSING

### Drive Shaft Housing Gears

Model	Gear Ratio	Year Range	Serial # Range	Drive Gear	Driven Gear/ Gear Kit	Upper Gear Repair Kit
IA & EZ Shift	1.84	1964 - 1966	1684188 - 2065186	N.S.S.	N.L.A.	N/A
IB & EZ Shift	2.01	1964 - 1966	1684188 - 2065186	N.S.S.	N.L.A.	N/A
IC & EZ Shift	1.68	1964 - 1966	1684188 - 2065186	N.S.S.	N.L.A.	N/A
120/140	1.98	1967 - 1969	2062141 - 2791956	N.S.S.	N.L.A.	N/A
120/140	1.98	1970 - 1982	2791957 - 6225576	N.S.S.	43- 55778A 3	N/A
470/485	1.84	1976 - 1982	4208730 - 6225575	N.S.S.	43- 75325A 3	N/A
160	1.68	1967 - 1969	2065190 - 2763441	N.S.S.	43- 45569A 5	N/A
165	1.65	1970 - 1981	2763442 and up	N.S.S.	43- 45814A 5	N/A
888	1.50	1971 - 1977	3106717 and up	N.S.S.	43- 18411A 2	N/A
225-S	1.50	1974	3856268 - 4200499	N.S.S.	43- 18411A 2	N/A
233	1.32	1975 - 1977	4200500 and up	N.S.S.	43-8M0080756	N/A
898/228	1.50	1977 - 1982	4782330 - 6225576	N.S.S.	43- 18411A 2	N/A
250	1.32	1977	4791300 - 4898729	N.S.S.	43-8M0080756	N/A
260	1.50	1978 - 1982	4898730 - 6225576	N.S.S.	43- 18411A 2	N/A
R/MR/Alpha One	1.98	1983 - 1990	6225577 - 0D469858	N.S.S.	43- 55778A 3	43-803101T 1
R/MR/Alpha One	1.84	1983 - 1990	6225577 - 0D469858	N.S.S.	43- 75325A 3	43-803114T 1
R/MR/Alpha One	1.65	1983 - 1990	6225577 - 0D469858	N.S.S.	43- 45814A 5	43-803112T 1
R/MR/Alpha One	1.50	1983 - 1990	6225577 - 0D469858	N.S.S.	43- 18411A 2	43-803116T 1(1)
R/MR/Alpha One	1.50 HD	1983 - 1990	6225577 - 0D469858	N.S.S.	43- 18411A 4	43-803116T 1
R/MR/Alpha One	1.32	1983 - 1990	6225577 - 0D469858	N.S.S.	43-8M0080756	43-803115T 1
Alpha One SS	1.50	1986 - 1989	0A545004 and up	N.S.S.	43- 18411A 4	43-803116T 1
Alpha One SS	1.32	1986 - 1989	0A545004 and up	N.S.S.	43-8M0080756	43-803115T 1
Alpha One Gen II	2.40	1991 - 1997	0D469859 - 0K999999	N.S.S.	43- 55778A 3	43-803118T 1
Alpha One Gen II	1.98/1.94	1991 - 1997	0D469859 - 0K999999	N.S.S.	43- 55778A 3	43-803118T 1
Alpha One Gen II	1.65/1.62	1991 - 1997	0D469859 - 0K999999	N.S.S.	43- 45814A 5	43-803119T 1
Alpha One Gen II	1.84/1.81	1991 - 1997	0D469859 - 0K999999	N.S.S.	43- 75325A 3	43-803120T 1
Alpha One Gen II	1.50/1.47	1991 - 1997	0D469859 - 0K999999	N.S.S.	43- 18411A 2	43-803102T 1
Alpha One Gen II	2.40	1998 - 2015	0L100040 and up	N.S.S.	43-853642A 2	43-803106T 1
Alpha One Gen II	2.00	1998 - 2015	0L100040 and up	N.S.S.	43-853640A 2	43-803104T 1
Alpha One Gen II	1.94	1998 - 2015	0L100040 and up	N.S.S.	43-853642A 2	43-803106T 1
Alpha One Gen II	1.81	1998 - 2015	0L100040 and up	N.S.S.	43-853643A 2	43-803105T 1
Alpha One Gen II	1.62	1998 - 2015	0L100040 and up	N.S.S.	43-853640A 2	43-803104T 1
Alpha One Gen II	1.47	1998 - 2015	0L100040 and up	N.S.S.	43-853641A 2	43-803103T 1
Vazer	2.77	2007 - 2009	0W995000 and up	N.S.S.	43-853642A 2	N/A
Vazer	2.58	2007 - 2009	0W995000 and up	N.S.S.	43-853643A 2	N/A

# MERCURY® MERCUISER® DRIVE SYSTEMS

Model	Gear Ratio	Year Range	Serial # Range	Drive Gear	Driven Gear/ Gear Kit	Upper Gear Repair Kit
Bravo I	1.65	1988 - 1995	0B664190 - 0F729999	N.L.A.(2)	43-883479A 4	43-803109T 2
Bravo I	1.65	1996 - 1999	0F730000 - 0M100000	N.L.A.(3)	43-883479A 3	43-803109T 2
Bravo I	1.65	2000 - 2004	0M100001 - 0W249999	N.S.S.	43-883479A 2	N/A
Bravo I	1.65	2004 - 2015	0W250000 and up	N.S.S.	43-8M0060005	N/A
Bravo I	1.50	1988 - 1995	0B664190 - 0F729999	N.L.A.(4)	43-883473A 4	43-803107T 2
Bravo I	1.50	1996 - 1999	0F730000 - 0M100000	N.L.A.(5)	43-883473A 3	43-803107T 2
Bravo I	1.50	2000 - 2004	0M100001 - 0W249999	N.S.S.	43-883473A 2	N/A
Bravo I	1.50	2004 - 2015	0W250000 and up	N.S.S.	43-8M0060003	N/A
Bravo I	1.36	1988 - 1995	0B664190 - 0F729999	N.L.A.(6)	43-883476A 4	43-803108T 2
Bravo I	1.36	1996 - 1999	0F730000 - 0M100000	N.L.A.(7)	43-883476A 3	43-803108T 2
Bravo I	1.36	2000 - 2015	0M100001 and up	N.S.S.	43-883476A 2	N/A
Bravo I - Diesel	1.65	1996 - 1999	0F730000 - 0M100000	N.S.S.	43-883479A 3	N/A
Bravo I - Diesel	1.50	1996 - 1999	0F730000 - 0M100000	N.S.S.	43-883473A 3	N/A
Bravo I - Diesel	1.36	1996 - 1999	0F730000 - 0M100000	N.S.S.	43-883476A 3	N/A
Bravo I Performance	1.65	1998 - 1999	0L000000 - 0M100000	N.L.A.(3)	43-883479A 3	N/A
Bravo I Performance	1.65	2000 - 2015	0M100001 and up	N.S.S.	43-883479A 2	N/A
Bravo I Performance	1.50	1998 - 1999	0L000000 - 0M100000	N.L.A.(5)	43-883473A 3	N/A
Bravo I Performance	1.50	2000 - 2015	0M100001 and up	N.S.S.	43-883473A 2	N/A
Bravo I Performance	1.36	1998 - 1999	0L000000 - 0M100000	N.L.A.(7)	43-883476A 3	N/A
Bravo I Performance	1.36	2000 - 2015	0M100001 and up	N.S.S.	43-883476A 2	N/A
Bravo I X	1.65	2000 - 2015	0M100001 and up	N.S.S.	43-887909A 1	N/A
Bravo I X	1.50	2000 - 2015	0M100001 and up	N.S.S.	43-887903A 1	N/A
Bravo I X	1.36	2000 - 2015	0M100001 and up	N.S.S.	43-887906A 1	N/A
Bravo I XR	1.26	2000 - 2015	0M100001 and up	43-849320T	43-840898A 3	N/A
Bravo I XR	1.35	2000 - 2015	0M100001 and up	43-849320T	43-840898A 3	N/A
Bravo I XR	1.50	2000 - 2015	0M100001 and up	43-849320T	43-840898A 3	N/A
Bravo I XZ	1.50	2000 - 2015	0M100001 and up	N.S.S.	43-887903A 1	N/A
Bravo I XZ	1.36	2000 - 2015	0M100001 and up	N.S.S.	43-887906A 1	N/A
Bravo II	2.20	1988 - 1995	0B664190 - 0F729999	N.L.A.(2)	43-883479A 4	43-803109T 2
Bravo II	2.20	1996 - 1999	0F730000 - 0M100000	N.L.A.(3)	43-883479A 3	43-803109T 2
Bravo II	2.20	2000 - 2004	0M100001 - 0W249999	N.S.S.	43-883479A 2	N/A
Bravo II	2.20	2004 - 2015	0W250000 and up	N.S.S.	43-8M0060005	N/A
Bravo II	2.00	1988 - 1995	0B664190 - 0F729999	N.L.A.(4)	43-883473A 4	43-803107T 2
Bravo II	2.00	1996 - 1999	0F730000 - 0M100000	N.L.A.(5)	43-883473A 3	43-803107T 2
Bravo II	2.00	2000 - 2004	0M100001 - 0W249999	N.S.S.	43-883473A 2	N/A
Bravo II	2.00	2004 - 2015	0W250000 and up	N.S.S.	43-8M0060003	N/A
Bravo II	1.81	1988 - 1995	0B664190 - 0F729999	N.L.A.(6)	43-883476A 4	43-803108T 2
Bravo II	1.81	1996 - 1999	0F730000 - 0M100000	N.L.A.(7)	43-883476A 3	43-803108T 2
Bravo II	1.81	2000 - 2004	0M100001 - 0W249999	N.S.S.	43-883476A 2	N/A
Bravo II	1.81	2004 - 2015	0W250000 and up	N.S.S.	43-8M0060004	N/A
Bravo II	1.65	1996 - 1999	0F730000 - 0M100000	N.L.A.(4)	43-883473A 3	43-803107T 2
Bravo II	1.65	2000 - 2004	0M100001 - 0W249999	N.S.S.	43-883473A 2	N/A
Bravo II	1.65	2004 - 2015	0W250000 and up	N.S.S.	43-8M0060003	N/A
Bravo II	1.50	1996 - 1999	0F730000 - 0M100000	N.L.A.(7)	43-883476A 3	43-803108T 2
Bravo II	1.50	2000 - 2015	0M100001 and up	N.S.S.	43-883476A 2	N/A
Bravo II - Diesel	2.20	1996 - 1999	0F730000 - 0M100000	N.S.S.	43-883479A 3	N/A
Bravo II - Diesel	2.00	1996 - 1999	0F730000 - 0M100000	N.S.S.	43-883473A 3	N/A
Bravo II - Diesel	1.81	1996 - 1999	0F730000 - 0M100000	N.S.S.	43-883476A 3	N/A
Bravo II - Diesel	1.65	1996 - 1999	0F730000 - 0M100000	N.S.S.	43-883473A 3	N/A
Bravo II - Diesel	1.50	1996 - 1999	0F730000 - 0M100000	N.S.S.	43-883476A 3	N/A
Bravo II X	2.20	2000 - 2015	0M100001 and up	N.S.S.	43-887909A 1	N/A
Bravo II X	2.00	2000 - 2015	0M100001 and up	N.S.S.	43-887903A 1	N/A
Bravo II X	1.81	2000 - 2015	0M100001 and up	N.S.S.	43-887906A 1	N/A
Bravo II X	1.65	2000 - 2015	0M100001 and up	N.S.S.	43-887903A 1	N/A

Not all parts listed are available for the European, C.I.S., Africa and Middle East Markets.  
 For more information, please contact your local Mercury, Mariner, MerCruiser or Quicksilver Office.

# MERCURY® MERCUISER® DRIVE SYSTEMS

Model	Gear Ratio	Year Range	Serial # Range	Drive Gear	Driven Gear/ Gear Kit	Upper Gear Repair Kit
Bravo II X	1.50	2000 - 2015	0M100001 and up	N.S.S.	43-887906A 1	N/A
Bravo III	2.43	1996 - 1999	0F730000 - 0M100000	N.L.A.(3)	43-883479A 3	43-803109T 2
Bravo III	2.43	2000 - 2004	0M100001 - 0W249999	N.S.S.	43-883479A 2	N/A
Bravo III	2.43	2004 - 2015	0W250000 and up	N.S.S.	43-8M0060005	N/A
Bravo III	2.20	1988 - 1995	0B664190 - 0F729999	N.L.A.(2)	43-883479A 4	43-803109T 2
Bravo III	2.20	1996 - 1999	0F730000 - 0M100000	N.L.A.(3)	43-883479A 3	43-803109T 2
Bravo III	2.20	2000 - 2004	0M100001 - 0W249999	N.S.S.	43-883479A 2	N/A
Bravo III	2.20	2004 - 2015	0W250000 and up	N.S.S.	43-8M0060005	N/A
Bravo III	2.00	1988 - 1995	0B664190 - 0F729999	N.L.A.(4)	43-883473A 4	43-803107T 2
Bravo III	2.00	1996 - 1999	0F730000 - 0M100000	N.L.A.(5)	43-883473A 3	43-803107T 2
Bravo III	2.00	2000 - 2004	0M100001 - 0W249999	N.S.S.	43-883473A 2	N/A
Bravo III	2.00	2004 - 2015	0W250000 and up	N.S.S.	43-8M0060003	N/A
Bravo III	1.81	1988 - 1995	0B664190 - 0F729999	N.L.A.(6)	43-883476A 4	43-803108T 2
Bravo III	1.81	1996 - 1999	0F730000 - 0M100000	N.L.A.(7)	43-883476A 3	43-803108T 2
Bravo III	1.81	2000 - 2004	0M100001 - 0W249999	N.S.S.	43-883476A 2	N/A
Bravo III	1.81	2004 - 2015	0W250000 and up	N.S.S.	43-8M0060004	N/A
Bravo III	1.65	1988 - 1995	0B664190 - 0F729999	N.L.A.(4)	43-883473A 4	43-803107T 2
Bravo III	1.65	1996 - 1999	0F730000 - 0M100000	N.L.A.(5)	43-883473A 3	43-803107T 2
Bravo III	1.65	2000 - 2004	0M100001 - 0W249999	N.S.S.	43-883473A 2	N/A
Bravo III	1.65	2004 - 2015	0W250000 and up	N.S.S.	43-8M0060003	N/A
Bravo III	1.50	1988 - 1995	0B664190 - 0F729999	N.L.A.(4)	43-883473A 4	43-803107T 2
Bravo III	1.50	1996 - 1999	0F730000 - 0M100000	N.L.A.(5)	43-883473A 3	43-803107T 2
Bravo III	1.50	2000 - 2015	0M100001 and up	N.S.S.	43-883473A 2	N/A
Bravo III	1.36	1996 - 1999	0F730000 - 0M100000	N.L.A.(7)	43-883476A 3	43-803108T 2
Bravo III	1.36	2000 - 2015	0M100001 and up	N.S.S.	43-883476A 2	N/A
Bravo III - Diesel	2.43	1996 - 1999	0F730000 - 0M100000	N.S.S.	43-883479A 3	N/A
Bravo III - Diesel	2.20	1996 - 1999	0F730000 - 0M100000	N.S.S.	43-883479A 3	N/A
Bravo III - Diesel	2.00	1996 - 1999	0F730000 - 0M100000	N.S.S.	43-883473A 3	N/A
Bravo III - Diesel	1.81	1996 - 1999	0F730000 - 0M100000	N.S.S.	43-883476A 3	N/A
Bravo III - Diesel	1.65	1996 - 1999	0F730000 - 0M100000	N.S.S.	43-883473A 3	N/A
Bravo III - Diesel	1.50	1996 - 1999	0F730000 - 0M100000	N.S.S.	43-883473A 3	N/A
Bravo III - Diesel	1.36	1996 - 1999	0F730000 - 0M100000	N.S.S.	43-883476A 3	N/A
Bravo III X	2.43	2000 - 2015	0M100001 and up	N.S.S.	43-887909A 1	N/A
Bravo III X	2.20	2000 - 2015	0M100001 and up	N.S.S.	43-887909A 1	N/A
Bravo III X	2.00	2000 - 2015	0M100001 and up	N.S.S.	43-887903A 1	N/A
Bravo III X	1.81	2000 - 2015	0M100001 and up	N.S.S.	43-887906A 1	N/A
Bravo III X	1.65	2000 - 2015	0M100001 and up	N.S.S.	43-887903A 1	N/A
Bravo III X	1.50	2000 - 2015	0M100001 and up	N.S.S.	43-887903A 1	N/A
Bravo III X	1.36	2000 - 2015	0M100001 and up	N.S.S.	43-887906A 1	N/A
Blackhawk	1.65	1994	0F186717 - 0F392505	N.L.A.(2)	43-883479A 4	N/A
Blackhawk	1.65	1994 - 2015	0F392506 and up	N.L.A.(5)	43-883473A 4	N/A
Blackhawk	1.50	1994 - 2015	0F186717 and up	N.L.A.(5)	43-883473A 4	N/A
Blackhawk	1.36	1994 - 2015	0F186717 and up	N.L.A.(6)	43-883476A 4	N/A
III	1.50	1968 - 1972	2373127 - 3002613	N.S.S.	N.L.A.	N/A
III	2.00	1968 - 1972	2373127 - 3002613	N.S.S.	N.L.A.	N/A
TR/TRS		1973 - 1993	3377316 and up	43- 62878	43- 62879T 1	N/A

(1) Some early 1.5 units with cone 89449 & cup 89410 must order an additional bearing 31-35990A 1

(2) Order gear kit 43-883479A 4

(3) Order gear kit 43-883479A 3

(4) Order gear kit 43-883473A 4

(5) Order gear kit 43-883473A 3

(6) Order gear kit 43-883476A 4

(7) Order gear kit 43-883476A 3



**SEAL KITS - DRIVESHAFT HOUSING**

**SEAL KIT**



**26- 32511A 1**

Fits I, IA/IB/IC, MC-I, R, MR & Alpha One (1964-1990)

**SEAL KIT**



**26- 88397A 1**

Driveshaft Hsg  
Fits Alpha One Gen II (1991 & newer)

**SEAL KIT**



**26- 16709A 2**

Driveshaft Hsg  
Fits Bravo I, II, III, X, XR & XZ

**SEAL & BEARING KITS - GEAR HOUSING**

**SEAL & BEARING KIT**

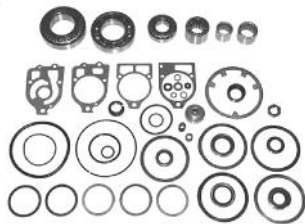

**31-803068T 1**

Fits R drive

**SEAL & BEARING KIT**

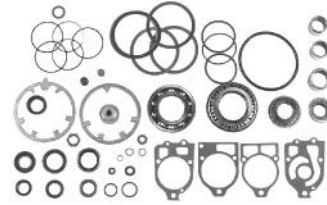

**31-803090T 1**

Standard Rotation (RH)  
Fits MR & Alpha One

**SEAL & BEARING KIT**

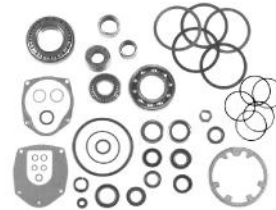

**31-803094T 1**

Standard Rotation (RH)  
Fits Alpha One Gen II (s/n 0D469859-0F679999)

**SEAL & BEARING KIT**



**31-803095T 1**

Standard Rotation (RH)  
Fits Alpha One Gen II (s/n 0F680000-0K999999)

**SEAL & BEARING KIT**



**31-803096T 1**

Standard Rotation (RH)  
Fits Alpha One Gen II (s/n 0L100040 and up)

# MERCURY® MERCURUISER® DRIVE SYSTEMS

## SEAL & BEARING KIT



**31-803080T02**

Fits Bravo I & I X

**31-803082T02**

Fits Bravo II & II X

**31-803085T02**

Fits Bravo III & III X

## SEAL KIT



**26- 76868A04**

Gearcase

Fits Bravo I, II, III & X

## SEAL KIT - PROPSHAFT



**26-815565A02**

Fits Bravo I XR/XZ

## SEAL KITS - GEAR HOUSING

### SEAL KIT



**26- 33144A 2**

Fits IA/IB/IC & EZ Shift, MC-I, R, MR, Alpha One & SS

### SEAL KIT



**26-816575A 3**

Fits Alpha One Gen II

## SEAL CHART - STERNDRIVE

### Stern Drive Seal Chart

Model	Year Range	Serial # Range	Driveshaft Housing Seal Kit	J-Joint Seal	Gear Housing Seal & Bearing Kit	Gear Housing Seal Kit	Bearing Carrier O-Ring	Bearing Carrier Seal
60/80/90	1965 - 1972	1830753 - 3225967	N/A	N.L.A.	N/A	N/A	25- 31986	26- 90562(1)
60/80/90	1965 - 1972	1830753 - 3225967	N/A	N.L.A.	N/A	N/A	25- 31986	N.L.A.(2)
I	1963	1534570 - 1684187	N/A	N.L.A.	N/A	N/A	25- 29976	26- 76868
IA/IB/IC & EZ Shift	1964 - 1966	1684188 - 2065186	26- 32511A 1	26-823894	N/A	26- 33144A 2	25- 31534	26- 76868
120/140	1967 - 1982	2062141 - 6225576	26- 32511A 1	26-823894	N/A	26- 33144A 2	25- 31534	26- 76868

# MERCURY® MERCUISER® DRIVE SYSTEMS

MERCURY® MERCUISER®

Model	Year Range	Serial # Range	Driveshaft Housing Seal Kit	J-Joint Seal	Gear Housing Seal & Bearing Kit	Gear Housing Seal Kit	Bearing Carrier O-Ring	Bearing Carrier Seal
470/485	1976 - 1982	4208730 - 6225575	26- 32511A 1	26-823894	N/A	26- 33144A 2	25- 31534	26- 76868
160/165	1967 - 1981	2065190 and up	26- 32511A 1	26-823894	N/A	26- 33144A 2	25- 31534	26- 76868
888	1971 - 1977	3106717 and up	26- 32511A 1	26-823894	N/A	26- 33144A 2	25- 31534	26- 76868
225/233	1974 - 1977	3856268 and up	26- 32511A 1	26-823894	N/A	26- 33144A 2	25- 31534	26- 76868
898/228/250/260	1977 - 1982	4782330 - 6225576	26- 32511A 1	26-823894	N/A	26- 33144A 2	25- 31534	26- 76868
R	1983	6225577 and up	26- 32511A 1	26-823894	31-803068T 1	26- 33144A 2	25- 31534	26- 76868
MR/Alpha One	1984 - 1990	6225577 - 0D469858	26- 32511A 1	26-823894	31-803090T 1	26- 33144A 2	25- 31534	26- 76868(3)
MR/Alpha One	1984 - 1990	6225577 - 0D469858	26- 32511A 1	26-823894	31-803090T 1	26- 33144A 2	25- 31534	26- 14077(1)
MR/Alpha One	1984 - 1990	6225577 - 0D469858	26- 32511A 1	26-823894	31-803090T 1	26- 33144A 2	25- 31534	26- 12224(2)
MR/Alpha One (CR)	1984 - 1990	6225577 - 0D469858	26- 32511A 1	26-823894	N.L.A.	26- 33144A 2	25- 31534	26- 14077(1)
MR/Alpha One (CR)	1984 - 1990	6225577 - 0D469858	26- 32511A 1	26-823894	N.L.A.	26- 33144A 2	25- 31534	26- 12224(2)
Alpha One SS	1986 - 1989	0A545004 and up	26- 32511A 1	26-823894	N/A	26- 33144A 2	25- 31534	26- 76868(3)
Alpha One SS	1986 - 1989	0A545004 and up	26- 32511A 1	26-823894	N/A	26- 33144A 2	25- 31534	26- 14077(1)
Alpha One SS	1986 - 1989	0A545004 and up	26- 32511A 1	26-823894	N/A	26- 33144A 2	25- 31534	26- 12224(2)
Alpha One Gen II	1991 - 1995	0D469859 - 0F679999	26- 88397A 1	26-823894	31-803094T 1	26-816575A 3	25- 31534	26- 14077(1)
Alpha One Gen II	1991 - 1995	0D469859 - 0F679999	26- 88397A 1	26-823894	31-803094T 1	26-816575A 3	25- 31534	26- 12224(2)
Alpha One Gen II (CR)	1991 - 1995	0D469859 - 0F679999	26- 88397A 1	26-823894	N.L.A.	26-816575A 3	25- 31534	26- 14077(1)
Alpha One Gen II (CR)	1991 - 1995	0D469859 - 0F679999	26- 88397A 1	26-823894	N.L.A.	26-816575A 3	25- 31534	26- 12224(2)
Alpha One Gen II	1996 - 1997	0F680000 - 0K999999	26- 88397A 1	26-823894	31-803095T 1	26-816575A 3	25- 31534	26- 14077(1)
Alpha One Gen II	1996 - 1997	0F680000 - 0K999999	26- 88397A 1	26-823894	31-803095T 1	26-816575A 3	25- 31534	26- 12224(2)
Alpha One Gen II (CR)	1996 - 2015	0F680000 and up	26- 88397A 1	26-823894	N.L.A.	26-816575A 3	25- 31534	26- 14077(1)
Alpha One Gen II (CR)	1996 - 2015	0F680000 and up	26- 88397A 1	26-823894	N.L.A.	26-816575A 3	25- 31534	26- 12224(2)
Alpha One Gen II	1998 - 2015	0L100040 and up	26- 88397A 1	26-823894	31-803096T 1	26-816575A 3	25- 31534	26- 14077(1)
Alpha One Gen II	1998 - 2015	0L100040 and up	26- 88397A 1	26-823894	31-803096T 1	26-816575A 3	25- 31534	26- 12224(2)
Bravo I	1988 - 2015	0B664190 and up	26- 16709A 2	26-807006	31-803080T02	26- 76868A04	25- 31534	26- 76868
Bravo I X	2000 - 2015	0M100001 and up	26- 16709A 2	26-807006	31-803080T02	26- 76868A04	25- 31534	26- 76868
Bravo I XR/XZ	2000 - 2015	0M100001 and up	26- 16709A 2	26-807006	N/A	26-815565A02	25- 31534	26-815565
Bravo II	1988 - 2015	0B664190 and up	26- 16709A 2	26-807006	31-803082T02	26- 76868A04	25- 34821	26-814242(2)
Bravo II	1988 - 2015	0B664190 and up	26- 16709A 2	26-807006	31-803082T02	26- 76868A04	25- 34821	26-821092(1)
Bravo II X	2000 - 2015	0M100001 and up	26- 16709A 2	26-807006	31-803082T02	26- 76868A04	25- 34821	26-814242(2)
Bravo II X	2000 - 2015	0M100001 and up	26- 16709A 2	26-807006	31-803082T02	26- 76868A04	25- 34821	26-821092(1)
Bravo III	1988 - 2015	0B664190 and up	26- 16709A 2	26-807006	31-803085T02	26- 76868A04	25-805331	26-861694
Bravo III X	2000 - 2015	0M100001 and up	26- 16709A 2	26-807006	31-803085T02	26- 76868A04	25-805331	26-861694
Blackhawk	1994 - 1995	0F186717 and up	26- 16709A 2	26-807006	N/A	N/A	25- 69201	26-861694
II	1962 - 1969	1474909 - 2671321	N/A	N/A	N/A	N/A	25- 31534	N.L.A.
III	1968 - 1972	2373127 - 3002613	N/A	N/A	N/A	N/A	N.L.A.	26- 19473
215E/H	1970 - 1972	2909035 - 2915034	N/A	N/A	N/A	N/A	25- 34821	26-821092
TR	1973 - 1993	3377316 and up	N/A	N/A	N/A	N/A	25- 34821	26-821092
TRS	1973 - 1993	3377316 and up	N/A	N/A	N/A	N/A	25- 31534	26- 76868

(1) Inner

(2) Outer

(3) W/o fishline cutter seal

Not all parts listed are available for the European, C.I.S., Africa and Middle East Markets.  
For more information, please contact your local Mercury, Mariner, MerCruiser or Quicksilver Office.

**GEAR REPAIR KITS - GEAR HOUSING**

**GEAR REPAIR KIT**

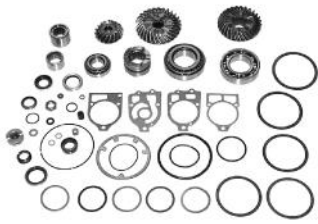

**43-803079T 1**

Fits R drive

**GEAR REPAIR KIT**



**43-803091T 1**

Standard Rotation (RH)  
Fits MR & Alpha One

**GEAR REPAIR KIT**



**43-803093T 1**

Counter Rotation (LH)  
Fits MR & Alpha One (C/R)

**GEAR REPAIR KIT**



**43-803069T 1**

Standard Rotation (RH)  
Fits Alpha One Gen II (except 2.40 ratio) (s/n 0D469859-0F679999)

**GEAR REPAIR KIT**



**43-803076T 1**

Counter Rotation (LH)  
Fits Alpha One Gen II (C/R) (s/n 0D469859-0F679999)

**GEAR REPAIR KIT**



**43-803071T 1**

Standard Rotation (RH)  
Fits Alpha One Gen II (except 2.40 ratio) (s/n 0F680000-0K999999)

**GEAR REPAIR KIT**



**43-803073T 1**

Standard Rotation (RH)  
Fits Alpha One Gen II (except 2.00 & 2.40 ratio) (s/n 0L100040 and up)

**43-803074T 1**

Standard Rotation (RH)  
Fits Alpha One Gen II (2.00 & 2.40 ratio) (s/n 0L100040 and up)

**GEAR REPAIR KIT**



**43-803081T02**

Fits Bravo I & I X

**GEAR REPAIR KIT**



**43-803083T02**

Fits Bravo II & II X (1.81, 2.00 & 2.20 ratio)

**GEAR REPAIR KIT**

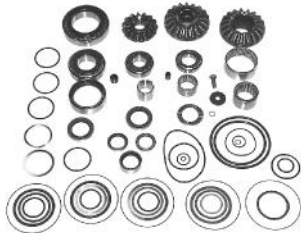

**43-803087T02**

Fits Bravo III & III X (1.65 ratio)

**43-803088T02**

Fits Bravo III & III X (1.81, 2.00 & 2.20 ratio)

**43-803089T02**

Fits Bravo III & III X (2.43 ratio)

**GEARS - GEAR HOUSING**

**FORWARD GEAR SET**



**43- 96084A 4**

17-28 teeth  
Fits MC-I drive

**FORWARD GEAR SET**



**43- 96084A 7**

17-28 teeth  
Fits R drive

**FORWARD GEAR SET**



**43-878087A 4**

13-21 teeth  
Fits MR/ Alpha One/ Gen II

**FORWARD GEAR SET**



**43-878087A 2**

13-21 teeth, Standard Rotation (RH)  
Fits Alpha One Gen II (except 2.00 & 2.40 ratio) (s/n 0F680000 and above)

**FORWARD GEAR SET**



**43-878617A 2**

14-28 teeth, Standard Rotation (RH)  
Fits Alpha One Gen II (2.00 & 2.40 ratio) (s/n 0L100040 and above)

**FORWARD GEAR SET**



**43- 13730A 1**

14-28 teeth, Standard Rotation  
Fits Alpha One Gen II (2.40 ratio) (s/n 0D469859-0K999999)

## FORWARD GEAR SET



### 43-828071A 1

13-21 teeth, Counter Rotation (LH)  
Fits MR, Alpha One & Gen II (C/R) (s/n 0F679999 and below)

## FORWARD GEAR SET



### 43-828289A 1

13-21 teeth, Counter Rotation  
Fits Alpha One Gen II (C/R) (except 2.00 ratio) (s/n 0F680000 and above)

## FORWARD GEAR SET



### 43-855651A 1

14-28 teeth, Counter Rotation (LH)  
Fits Alpha One Gen II (2.00 ratio) (s/n 0L100040 and above)

## FORWARD GEAR SET



### 43-898440A03

13-30 teeth  
Fits Vazer

## FORWARD GEAR SET



### 43-14063A 1

15-19 teeth  
Fits Bravo I & I X

## GEAR SET



### 43-818928A 2

15-19 teeth  
Fits Bravo I XR & XZ (1.36 & 1.50 ratio)

## FORWARD GEAR



### 43-827303

25 teeth  
Fits Bravo II & II X (1.50 & 1.65 ratio)

## FORWARD GEAR SET



### 43-41657T

27 teeth  
Fits Bravo II & II X (1.81, 2.00 & 2.20 ratio)

**FORWARD GEAR SET**



**43-805448A 1**

15-19-19 teeth  
Fits Bravo III & III X (1.36 & 1.50 ratio)

**FORWARD GEAR SET**



**43-828336A 1**

13-24-24 teeth  
Fits Bravo III & III X (2.43 ratio)

**FORWARD GEAR SET**



**43-824517A 1**

18-25-25 teeth  
Fits Bravo III & III X/ XR (1.65 ratio)

**FORWARD GEAR SET**



**43- 70933**

18 teeth  
Fits TRS (1.50 ratio)

**FORWARD GEAR SET**



**43-822535A 1**

16-27-27 teeth  
Fits Bravo III, III X (1.81, 2.00 & 2.20 ratio) & III XR (2.00 ratio)

**PINION GEAR**



**43- 41656T**

16 teeth  
Fits Bravo II & II X (1.81, 2.00 & 2.20 ratio)

**FORWARD GEAR SET**



**43-841910A01**

17-26-26 teeth  
Fits Bravo III XR (1.81 ratio)

**PINION GEAR**



**43-827304T**

18 teeth  
Fits Bravo II (1.50 & 1.65 ratio)



**PINION GEAR**



**43- 70934T 1**

15 teeth  
Fits TRS (1.50 ratio)

**REVERSE GEAR**



**43-853593A 1**

28 teeth (2.00/2.40 ratio)  
Fits Alpha I Gen II

**REVERSE GEAR**



**43- 31887**

**REVERSE GEAR**



**43-828290T 2**

21 teeth  
Fits Alpha One Gen II (CR)(s/n 0F680000 & up)

**REVERSE GEAR**

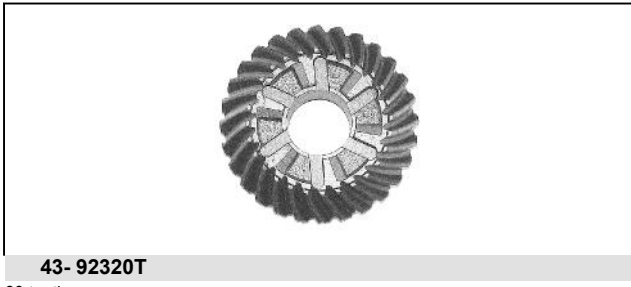

**43- 92320T**

28 teeth  
Fits R drive

**REVERSE GEAR**



**43-855652T 1**

28 teeth  
Fits Alpha I Gen II (CR) (2.00 ratio)

**REVERSE GEAR**



**43-828073A 1**

21 teeth  
Fits Alpha I Gen II

**REVERSE GEAR**



**43-824109A 1**



REVERSE GEAR



43-898441A01

30 teeth  
Fits Vazer

GEAR CHART - GEAR HOUSING

Gear Case Gears

Model	Gear Ratio	Year Range	Serial # Range	Gear Housing Repair Kit	Forward Gear	Pinion Gear	Reverse Gear
I	2.00	1963	1534570 - 1536617	N/A	N.L.A.	N.L.A.	43- 31887
I	2.00	1963	1536618 - 1684187	N/A	N.L.A.	N.L.A.	N.L.A.
IA	1.84	1964 - 1966	1684188 - 1776348	N/A	N.L.A.	N.L.A.	N.L.A.
IB	2.01	1964 - 1966	1684633 - 1775192	N/A	N.L.A.	N.L.A.	N.L.A.
IC	1.68	1964 - 1966	1685240 - 1777798	N/A	N.L.A.	N.L.A.	N.L.A.
IA EZ Shift	1.84	1964 - 1966	1776449 - 2065189	N/A	N.L.A.	N.L.A.	43- 37964
IB EZ Shift	2.01	1964 - 1966	1775193 - 2065189	N/A	N.L.A.	N.L.A.	43- 37964
IC EZ Shift	1.68	1964 - 1966	1777799 - 2065189	N/A	N.L.A.	N.L.A.	43- 37964
120/140	1.98	1967 - 1972	2062141 - 3443920	N/A	N.L.A.	N.L.A.	43- 37964
120/140	1.98	1972 - 1977	3469428 - 4893634	N/A	43- 96084A 4	N/A	N.L.A.
120/140	1.98	1978 - 1982	4893635 - 6225576	N/A	43- 96084A 4	N/A	N/A
470/485	1.84	1976 - 1977	4208730 - 4893934	N/A	43- 96084A 4	N/A	N.L.A.
470/485	1.84	1978 - 1982	4893835 - 6225575	N/A	43- 96084A 4	N/A	N/A
160	1.68	1967 - 1969	2065190 - 2763441	N/A	N.L.A.	N.L.A.	43- 37964
165	1.65	1970 - 1977	2763442 - 4890459	N/A	43- 96084A 4	N/A	N.L.A.
165	1.65	1978 - 1981	4890460 and up	N/A	43- 96084A 4	N/A	N/A
888	1.50	1971 - 1977	3106717 and up	N/A	43- 96084A 4	N/A	N.L.A.
225/233	1.50/1.32	1974 - 1977	3856268 and up	N/A	43- 96084A 4	N/A	N.L.A.
898/228	1.65/1.50	1977 - 1982	4782330 - 6225576	N/A	43- 96084A 4	N/A	N/A
250/260	1.50/1.32	1977 - 1982	4791300 - 6225576	N/A	43- 96084A 4	N/A	N/A
R	ALL	1983	6225577 - 6810537	43-803079T 1	43- 96084A 7	N/A	43- 92320T
MR/Alpha One	ALL	1984 - 1990	6810538 - 0D469858	43-803091T 1	43-878087A 4	N/A	43-824109A 1
MR/Alpha One (CR)	ALL	1984 - 1990	6810538 - 0D469858	43-803093T 1	43-828071A 1	N/A	N.L.A.
Alpha One SS	ALL	1986 - 1989	0A545004 and up	N/A	43-878087A 4	N/A	43-824109A 1
Alpha One Gen II	1.98/1.84/1.65/1.50	1991 - 1995	0D469859 - 0F679999	43-803069T 1	43-878087A 4	N/A	43-824109A 1
Alpha One Gen II	2.40	1991 - 1995	0D469859 - 0F679999	N.L.A.	43- 13730A 1	N/A	N/A
Alpha One Gen II (CR)	ALL	1991 - 1995	0D469859 - 0F679999	43-803076T 1	43-828071A 1	N/A	N.L.A.
Alpha One Gen II	1.94/1.81/1.62/1.47	1996 - 1997	0F680000 - 0K999999	43-803071T 1	43-878087A 2	N/A	43-828073A 1
Alpha One Gen II	2.40	1996 - 1997	0F680000 - 0K999999	N.L.A.	N.L.A.	N/A	N/A
Alpha One Gen II (CR)	1.94/1.81/1.62/1.47	1996 - 1997	0F680000 - 0K999999	N.L.A.	43-828289A 1	N/A	43-828290T 2
Alpha One Gen II	1.94/1.81/1.62/1.47	1998 - 2015	0L100040 and up	43-803073T 1	43-878087A 2	N/A	43-828073A 1
Alpha One Gen II	2.00/2.40	1998 - 2015	0L100040 and up	43-803074T 1	43-878617A 2	N/A	43-853593A 1
Alpha One Gen II (CR)	1.94/1.81/1.62/1.47	1998 - 2015	0L100040 and up	N.L.A.	43-828289A 1	N/A	43-828290T 2
Alpha One Gen II (CR)	2.00	1998 - 2015	0L100040 and up	N/A	43-855651A 1	N/A	43-855652T 1
Vazer	2.77/2.58	2007 - 2009	0W995000 and up	N/A	43-898440A03	N/A	43-898441A01

Not all parts listed are available for the European, C.I.S., Africa and Middle East Markets.  
For more information, please contact your local Mercury, Mariner, MerCruiser or Quicksilver Office.

# MERCURY® MERCUISER® DRIVE SYSTEMS

Model	Gear Ratio	Year Range	Serial # Range	Gear Housing Repair Kit	Forward Gear	Pinion Gear	Reverse Gear
Bravo I	ALL	1988 - 2015	0B664190 and up	43-803081T02	43- 14063A 1	N/A	N/A
Bravo I X	ALL	2000 - 2015	0M100001 and up	43-803081T02	43- 14063A 1	N/A	N/A
Bravo I XR/XZ	1.50/1.36	2000 - 2015	0M100001 and up	N/A	43-818928A 2	N/A	N/A
Bravo II & II X	1.81/2.00/2.20	1988 - 2015	0B664190 and up	43-803083T02	43- 41657T	43- 41656T	N/A
Bravo II & II X	1.50/1.65	1988 - 2015	0B664190 and up	N.L.A.	43-827303	43-827304T	N/A
Bravo III & III X	1.36/1.50	1988 - 2015	0B664190 and up	N.L.A.	43-805448A 1	N/A	N/A
Bravo III & III X	1.65	1988 - 2015	0B664190 and up	43-803087T02	43-824517A 1	N/A	N/A
Bravo III & III X	1.81/2.00/2.20	1988 - 2015	0B664190 and up	43-803088T02	43-822535A 1	N/A	N/A
Bravo III & III X	2.43	1988 - 2015	0B664190 and up	43-803089T02	43-828336A 1	N/A	N/A
Bravo III XR	1.65	2004 - 2015	0W240000 and up	43-803087T02	43-824517A 1	N/A	N/A
Bravo III XR	1.81	2004 - 2015	0W240000 and up	N/A	43-841910A01	N/A	N/A
Bravo III XR	2.00	2004 - 2015	0W240000 and up	43-803088T02	43-822535A 1	N/A	N/A
Blackhawk	1.36/1.50	1994 - 2015	0F186717 and up	N/A	43-805448A 1	N/A	N/A
Blackhawk	1.65	1994	0F186717 - 0F392505	N/A	43-805448A 1	N/A	N/A
Blackhawk	1.65	1994 - 2015	0F392506 and up	N/A	43-824517A 1	N/A	N/A
Blackhawk	1.81	1994 - 2015	0F186717 and up	N/A	43-822535A 1	N/A	N/A
TR	2.00	1973 - 1993	3377316 and up	N/A	N.L.A.	N.L.A.	N/A
TRS	1.33	1973 - 1993	3377316 and up	N/A	N.L.A.	N.L.A.	N/A
TRS	1.50	1973 - 1993	3377316 and up	N/A	43- 70933	43- 70934T 1	N/A

**MERCURY® MERCRUISER® POWER TRIM**

**POWER TRIM PUMPS AND COMPONENTS**

**TRIM PUMP ASSEMBLY**



**93247A 7**

Replacement pump for older Prestolite high pressure/low flow system

**865380A25**

Oildyne low pressure/high flow

**TRIM PUMP ASSEMBLY**



**865380A13**

Oildyne low pressure/high flow with top mount reservoir

**P/T PUMP MOTOR**



**891736T**

For Oildyne P/T pump w/metal or plastic reservoir  
Fits 1991 & newer Alpha One Gen II drives, also fits 1988 & newer Bravo drives.

**P/T PUMP MOTOR**



**17649A02**

For Oildyne P/T pump w/plastic reservoir

**P/T PUMP MOTOR ARMATURE**



**392- 2943**

For Prestolite P/T pump w/metal reservoir

**BRUSH SET**

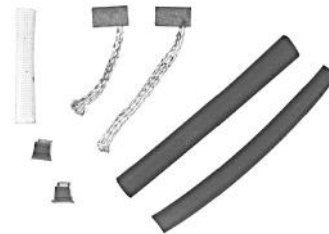

**392- 8989**

For Prestolite P/T Motor

**SPRING SET**

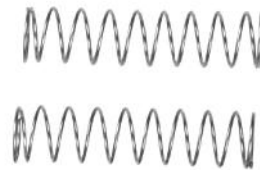

**392- 2529**

For Prestolite P/T pumps w/metal reservoir

**COMMUTATOR HEAD**

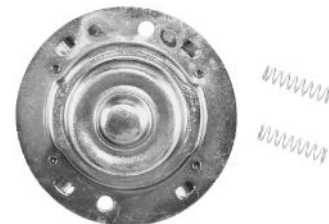

**392- 2940**

For Prestolite P/T motor

**COMMUTATOR HEAD**



**392- 8262**  
For Prestolite P/T Motor

**RESERVOIR**

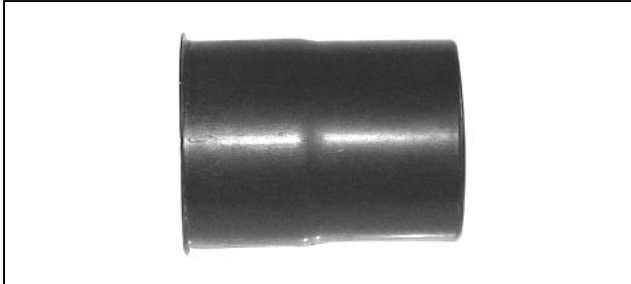

**41219T**  
For Oildyne w/metal reservoir

**RESERVOIR KIT**



**883166A 2**  
Top mount reservoir  
For Oildyne P/T pump with plastic reservoir

**RESERVOIR UPDATE KIT**



**883169A 1**  
Top mount reservoir  
For Oildyne P/T pump w/plastic reservoir

**OVERHAUL REPAIR KIT**



**18545A 1**  
For Oildyne P/T pump

**SOLENOID**



**25661T 1**

**SOLENOID**



**89- 96158T**  
Stepped mounting plate  
Fits Outboard Starters & MerCruiser Starters and Pwr Trim.

**SOLENOID**



**89-853654A 1**  
Fits Outboard 2 Cyl. & In-Line 6 & MCM applications

MERCURY® MERCUISER®

**POWER TRIM SENDER**



**805320A03**

Includes trim limit switch also.  
Fits MC-I, R, MR, Alpha One, Gen II, Bravo drives.

**P/T SENDER ROTOR KIT**



**805134A 4**

Replacement rotor

**TRIM CYLINDER REPAIR KITS**

**TRIM CYLINDER OVERHAUL KIT**

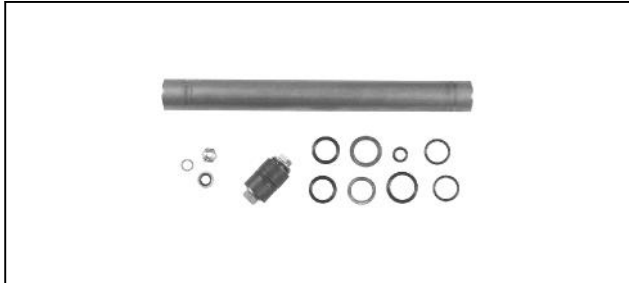

**45522A 3**

For MC-I drive

**TRIM CYLINDER OVERHAUL KIT**



**87399A 2**

For R, MR, Alpha One & Bravo

**TRIM CYLINDER OVERHAUL KIT**



**87399A 3**

For Alpha One Gen II

**TRIM CYLINDER OVERHAUL KIT**



**86611A 1**

For TR/TRS

**TRIM CYLINDER O-RING KITS**

**TRIM CYLINDER O-RING KIT**



**25- 60342A 2**

For MC-I drive trim cylinder having internal trim lines

**TRIM CYLINDER O-RING KIT**

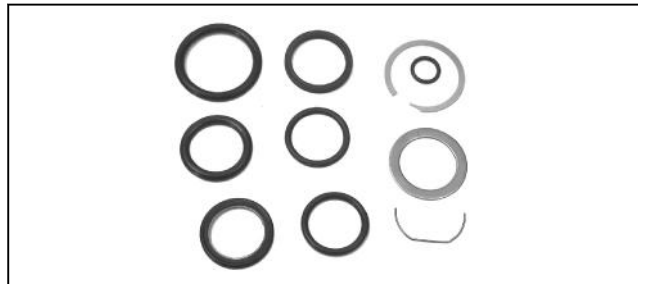

**25- 60342A 3**

For MC-I drive trim cylinder having external trim lines

# MERCURY® MERCRUISER® POWER TRIM

## TRIM CYLINDER O-RING KIT



**25- 87400A 2**

For R, MR, Alpha One, Gen II & Bravo

## TRIM CYLINDER O-RING KIT



**25- 79871A 1**

For TR/TRS

## TRIM CYLINDER O-RING KIT

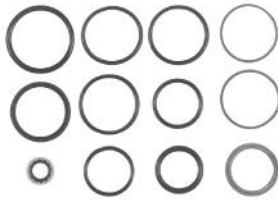

**25- 47389A 2**

For TR/TRS, 215H & II drive

MERCURY® MERCRUISER®

## TRIM CYLINDER CHART

### Trim Cylinders

Model	Year Range	Serial # Range	Replacement Trim Cylinder - Port	Replacement Trim Cylinder - Starboard	Original Trim Cylinder Overhaul Kit	Original Trim Cylinder Outer Housing - Port	Original Trim Cylinder Outer Housing - Stbd.	Original Trim Cylinder Seal Kit
120/140	1967 - 1969	2062141 - 2791956	45706A14	45706A14	N/A	N/A	N/A	N/A
120/140	1970 - 1977	2791957 - 4893634	45706A14	45706A14	45522A 3	77442A 1	77442A 1	25- 60342A 2
120/140	1978 - 1982	4893635 - 6225576	45706A14(13)	45706A14(13)	45522A 3	77442A 1	77442A 1	25- 60342A 2
120/140	1978 - 1982	4893635 - 6225576	87173A10(14)	87173A10(14)	N.L.A.	N.L.A.	N.L.A.	25- 60342A 3
470/485	1976 - 1977	4208730 - 4893934	45706A14	45706A14	45522A 3	77442A 1	77442A 1	25- 60342A 2
470/485	1978 - 1982	4893835 - 6225575	45706A14(13)	45706A14(13)	45522A 3	77442A 1	77442A 1	25- 60342A 2
470/485	1978 - 1982	4893835 - 6225575	87173A10(14)	87173A10(14)	N.L.A.	N.L.A.	N.L.A.	25- 60342A 3
160	1967 - 1969	2065190 - 2763441	45706A14	45706A14	N/A	N/A	N/A	N/A
165	1970 - 1977	2763442 - 4890459	45706A14	45706A14	45522A 3	77442A 1	77442A 1	25- 60342A 2
165	1978 - 1981	4890460 - 4890459	45706A14(13)	45706A14(13)	45522A 3	77442A 1	77442A 1	25- 60342A 2
165	1978 - 1981	4890460 - 4890459	87173A10(14)	87173A10(14)	N.L.A.	N.L.A.	N.L.A.	25- 60342A 3
888	1971 - 1977	3106717 and up	45706A14	45706A14	45522A 3	77442A 1	77442A 1	25- 60342A 2
225/233	1974 - 1977	3856268 and up	45706A14	45706A14	45522A 3	77442A 1	77442A 1	25- 60342A 2
898/228	1977	4782330 - 4898729	45706A14	45706A14	45522A 3	77442A 1	77442A 1	25- 60342A 2
898/228	1978 - 1982	4898730 - 6225576	45706A14(13)	45706A14(13)	45522A 3	77442A 1	77442A 1	25- 60342A 2
898/228	1978 - 1982	4898730 - 6225576	87173A10(14)	87173A10(14)	N.L.A.	N.L.A.	N.L.A.	25- 60342A 3
250	1977	4791300 - 4898729	45706A14	45706A14	45522A 3	77442A 1	77442A 1	25- 60342A 2
260	1978 - 1982	4898730 - 6225576	45706A14(13)	45706A14(13)	45522A 3	77442A 1	77442A 1	25- 60342A 2
260	1978 - 1982	4898730 - 6225576	87173A10(14)	87173A10(14)	N.L.A.	N.L.A.	N.L.A.	25- 60342A 3
R/MR/Alpha One	1983 - 1990	6225577 - 0D469858	98703A 3(11)	98704A 3(11)	87399A 2	98703T(5)	98704T(7)	25- 87400A 2
R/MR/Alpha One	1983 - 1990	6225577 - 0D469858	98703A 3(11)	98704A 3(11)	87399A 2	98703A10(6)	98704A10(8)	25- 87400A 2
R/MR/Alpha One	1983 - 1990	6225577 - 0D469858	14035A 3(12)	14034A 3(12)	87399A 2	14035F 1(4)	14034F 1(3)	25- 87400A 2
Alpha One SS	1986 - 1989	0A545004 and up	98703A 3(11)	98704A 3(11)	87399A 2	98703T(5)	98704T(7)	25- 87400A 2

Model	Year Range	Serial # Range	Replacement Trim Cylinder - Port	Replacement Trim Cylinder - Starboard	Original Trim Cylinder Overhaul Kit	Original Trim Cylinder Outer Housing - Port	Original Trim Cylinder Outer Housing - Stbd.	Original Trim Cylinder Seal Kit
Alpha One SS	1986 - 1989	0A545004 and up	98703A 3(11)	98704A 3(11)	87399A 2	98703A10(6)	98704A10(8)	25- 87400A 2
Alpha One SS	1986 - 1989	0A545004 and up	14035A 3(12)	14034A 3(12)	87399A 2	14035F 1(4)	14034F 1(3)	25- 87400A 2
Alpha One Gen II	1991 - 2015	0D469859 and up	815935A 7	815954A 7	87399A 3	815935T	815954T	25- 87400A 2
Vazer	2007 - 2009	0W995000 and up	866524A01	866524A01	N/A	N/A	N/A	N/A
Bravo	1988 - 2015	0B664190 and up	98703A26	98704A26	87399A 2	98703T	98704T	25- 87400A 2
Bravo SeaCore	2007 - 2015	0W900000 and up	866465A02	866464A02	87399A 2	N/A	N/A	25- 87400A 2
Blackhawk	1994 - 1995	0F186717 and up	98703A26	98704A26	87399A 2	98703T	98704T	25- 87400A 2
II (1.78)	1968 - 1969	2398798 - 2671321	N.L.A.	N.L.A.	N/A	N/A	N/A	N/A
III	1968 - 1972	2373127 - 3002613	N.L.A.	N.L.A.	N/A	N/A	N/A	N/A
215H	1970	2782203 - 2909034	N.L.A.	N.L.A.	N/A	N/A	N/A	N/A
215E	1970 - 1972	2909035 - 2915034	N.L.A.	N.L.A.	N/A	N/A	N/A	N/A
TR/TRS	1973 - 1993	3377316 and up	N.L.A.(10)	N.L.A.(10)	N/A(10)	47342A22(2)	47342A22(2)	25- 47389A 2(10)
TR/TRS	1973 - 1993	3377316 and up	N.L.A.(10)	N.L.A.(10)	N/A(10)	N.L.A.(1)	N.L.A.(1)	25- 47389A 2(10)
TR/TRS	1973 - 1993	3377316 and up	87411A 3(9)	87412A 3(9)	86611A 1(9)	87411A 6(9)	N.L.A.(9)	25- 79871A 1(9)

- (1) 11-3/8 inch long tubes- internal cylinder lines
- (2) 13-3/4 inch long tubes- internal cylinder lines
- (3) Casting# 14034 1
- (4) Casting# 14035 1
- (5) Casting# 98703
- (6) Casting# 98703 1
- (7) Casting# 98704
- (8) Casting# 98704 1
- (9) External trim lines
- (10) Internal trim lines
- (11) Use with 15-9/16 inch long trim cylinder tube
- (12) Use with 16-3/16 inch long trim cylinder tube
- (13) Trim cylinder with internal trim lines
- (14) Trim cylinders using external trim lines

**TRIM CYLINDER ANCHOR PINS & KITS**

**FRONT ANCHOR PIN KIT**



**17- 14873A 1**

11.87 in. OAL, .625 in. O.D., 7/16-20 threads  
Fits R, MR & Alpha One

**REAR ANCHOR PIN KIT**

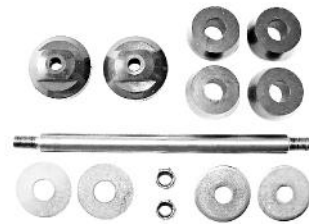

**17- 14872A 1**

9.18 in. OAL, .625 in. O.D., 7/16-20 threads  
Fits R, MR & Alpha One

**FRONT AND REAR ANCHOR PIN KIT**



**8M0065070**

Fits Alpha One Gen II

**REAR ANCHOR PIN KIT**



**17- 44166T 1**

Fits Bravo I, II, III, X, XR & XZ

**REAR ANCHOR PIN KIT**

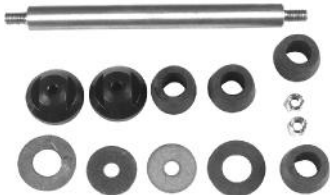

**17- 14874A 1**

10.68 in. OAL, .875 in. O.D., 7/16-20 threads

Fits TR/TRS, 215E/H, II & III drive

**FRONT ANCHOR PIN**



**17- 45735**

10.59 in. OAL, .625 in O.D., 3/8-24 threads

Fits MC-I drive

**REAR ANCHOR PIN**



**17- 45738**

7.75 in. OAL, .625 in. O.D., 3/8-24 threads

Fits MC-I drive

**FRONT ANCHOR PIN**



**17- 14873**

11.87 in OAL, .625 in., 7/16-20 threads

Note: If using on a 1986 & older R, MR or Alpha One with 3/8-24 threaded anchor pin, order complete kit 17-14873A1

Fits 1986-1990 Alpha One

**REAR ANCHOR PIN**



**17- 45738**

7.75 in. OAL, .625 in O.D., 3/8-24 threads

Fits MC-I drive

**FRONT & REAR ANCHOR PIN**



**17-815953A01**

10.73 in. OAL, .625 in. O.D.

Fits Alpha One Gen II



**FRONT ANCHOR PIN**



**17-44167A 1**

11.87 in. OAL, .750 in. O.D., 7/16-20 threads  
Fits Bravo I, II, III, X, XR & XZ

**REAR ANCHOR PIN**



**17-805095**

10.85 in. OAL, .750 in. O.D., 7/16-20 threads  
Fits Blackhawk

**REAR ANCHOR PIN**



**17-44166**

9.18 in. OAL, .750 in. O.D., 7/16-20 threads  
Fits Bravo I, II, III, X, XR & XZ

**TRIM CYLINDER ANCHOR PIN CHART**

**Trim Cylinder Hardware**

Model	Year Range	Serial # Range	Anchor Pin - Front	Anchor Pin - Rear	Front Anchor Pin Kit	Rear Anchor Pin Kit	Trim Cylinder Bushings
120/140	1970 - 1982	2791957 - 6225576	17-45735	17-45738	N/A	N/A	23-89574
470/485	1978 - 1977	4208730 - 6225575	17-45735	17-45738	N/A	N/A	23-89574
165	1970 - 1981	2763442 and up	17-45735	17-45738	N/A	N/A	23-89574
888/225/233	1971 - 1977	3106717 and up	17-45735	17-45738	N/A	N/A	23-89574
898/228/250/260	1977 - 1982	4782330 - 6225576	17-45735	17-45738	N/A	N/A	23-89574
R/MR/Alpha One	1983 - 1990	6225577 - 0D469858	17-14873	17-14872	17-14873A 1	17-14872A 1	23-99291T
Alpha One Gen II	1991 - 2015	0D469859 and up	17-815953A01	17-815953A01	8M0065070	8M0065070	23-815950 1
Bravo I/II/III	1988 - 2015	0B664190 and up	17-44167A 1	17-44166	N/A	17-44166T 1	23-807073
Blackhawk	1994 - 1995	0F186717 and up	N.L.A.	17-805095	N/A	N/A	23-807073
II (1.78)	1968 - 1969	2398798 - 2671321	N.L.A.	N/A	N/A	17-14874A 1	23-90203
III	1968 - 1972	2373127 - 3002613	N/A	N/A	N.L.A.	17-14874A 1	23-90203
215E/H	1970 - 1972	2782203 - 2915034	N/A	N/A	N.L.A.	17-14874A 1	23-90203
TR/TRS	1973 - 1993	3377316 and up	N/A	N/A	N.L.A.	17-14874A 1	23-90203

**POWER TRIM CYLINDER HOSES**

**POWER TRIM HOSE**



**32- 45703**

Trim cylinder to connector block  
Port - down pressure  
Fits 120, 140 & 160 drives

**POWER TRIM HOSE**



**32- 45974**

Trim cylinder to connector block  
Port - up pressure  
Fits 120, 140 & 160 drives

**POWER TRIM HOSE**



**32- 69871**

Trim cylinder to connector block  
Starboard - down pressure  
Fits 120, 140 & 160 drives

**POWER TRIM HOSE**



**32- 45973**

Trim cylinder to connector block  
Starboard - up pressure

**POWER TRIM HOSE**



**32- 86036T**

A UV radiation resistant stainless steel braided power trim hose.  
Port & starboard - up and down pressures.  
Fits MC-I drive (s/n 6225576 and below), and MC II, III, 215 E/H, TR and TRS drives.  
Mercury Branded, Peg Display Product Point of Sale Packaged.

**32- 86036Q**

A UV radiation resistant stainless steel braided power trim hose.  
Port & starboard - up and down pressures.  
Fits MC-I drive (s/n 6225576 and below), and MC II, III, 215 E/H, TR and TRS drives.  
Quicksilver Branded, Peg Display Product Point of Sale Packaged.

**POWER TRIM HOSE**

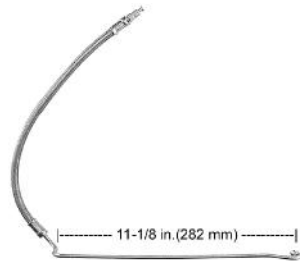

**32- 87234**

Trim cylinder to connector block, use w/ cylinders requiring external trim lines  
Port - down pressure  
Fits MC-I drive (s/n 6225576 and below)

**POWER TRIM HOSE**

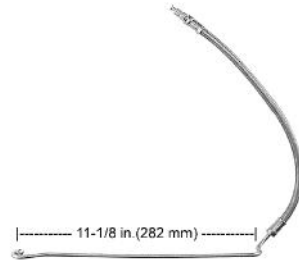

**32- 87235**

Trim cylinder to connector block, use w/ cylinders requiring external trim lines  
Starboard - down pressure  
Fits MC-I drive (s/n 6225576 and below)

**POWER TRIM HOSE**

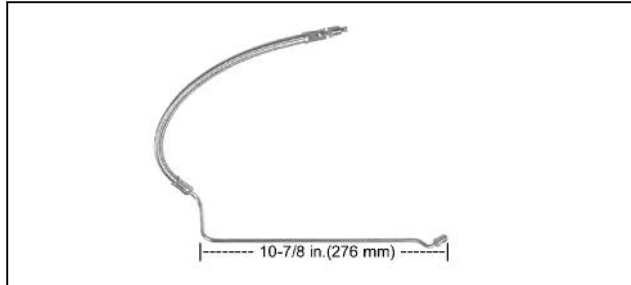

**32-864588**

Trim cylinder to connector block  
Port - down pressure  
Fits R, MR, Alpha One & Bravo I, II, III, X, XR & XZ

**POWER TRIM HOSE**

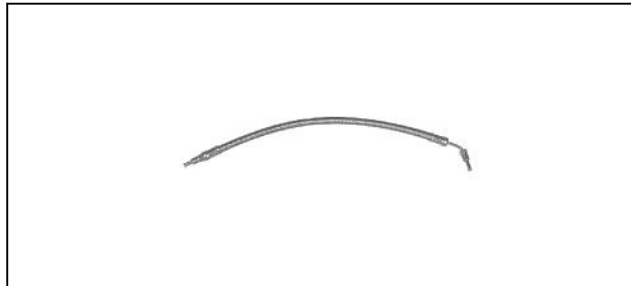

**32-99904K**

Trim cylinder to connector block  
Port & starboard - up pressure  
Fits R, MR, Alpha One, Gen II & Bravo I, II, III, X, XR & XZ  
Mercury Branded, Peg Display Product Point of Sale Packaged.

**32-99904Q**

Trim cylinder to connector block  
Port & starboard - up pressure  
Fits R, MR, Alpha One, Gen II & Bravo I, II, III, X, XR & XZ  
Quicksilver Branded, Peg Display Product Point of Sale Packaged.

**POWER TRIM HOSE**

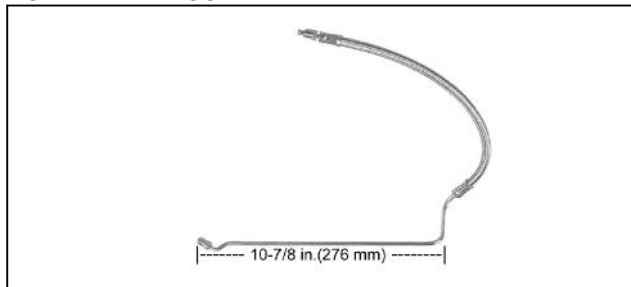

**32-864589**

Trim cylinder to connector block  
Starboard - down pressure  
Fits R, MR, Alpha One & Bravo I, II, III, X, XR & XZ

**POWER TRIM HOSE**

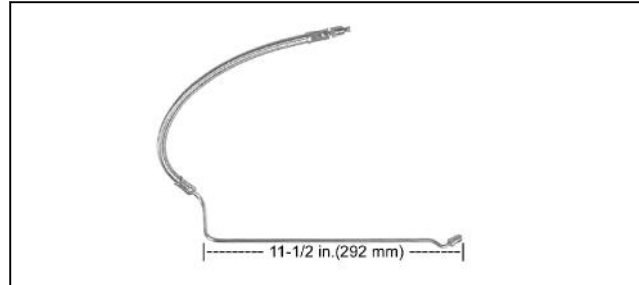

**32-864959**

Trim cylinder to connector block  
Port - down pressure  
Fits R, MR, Alpha One & Gen II

**POWER TRIM HOSE**

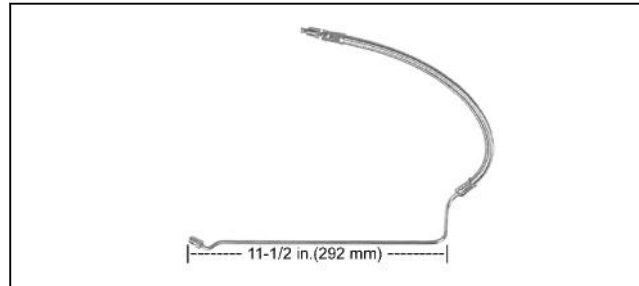

**32-864960**

Trim cylinder to connector block  
Starboard - down pressure  
Fits R, MR, Alpha One & Gen II

**POWER TRIM HOSE**

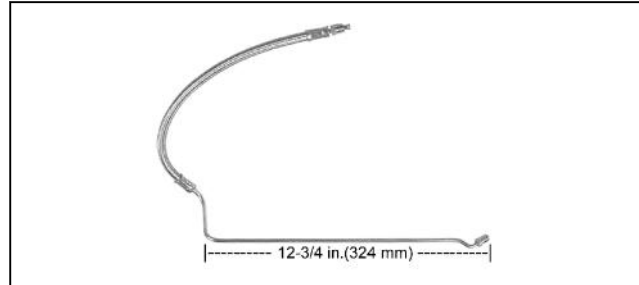

**32-87558**

Trim cylinder to connector block, use w/ cylinders requiring external trim lines  
Port - down pressure  
Fits TR & TRS

**POWER TRIM HOSE**

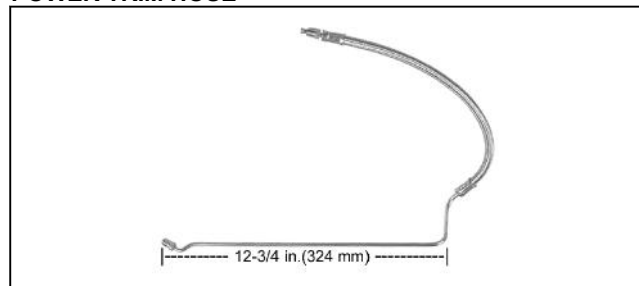

**32-87559**

Trim cylinder to connector block, use w/ cylinders requiring external trim lines  
Starboard - down pressure  
Fits TR & TRS



**TABLE OF CONTENTS**

**Evinrude®/Johnson®** ..... 246

**Yamaha** ..... 249

**Volvo** ..... 250

**OMC** ..... 251

**EVINRUDE®/JOHNSON®**

**IGNITION COIL**



**802371A 1**

Outboard Marine Corp. P/N: 582995  
584477

**FUEL LINE CONNECTOR**



**22-802196Q**

For Johnson & Evinrude Outboards - 5/16 (7.9mm)"Tank End/Engine End" (SMALL Inlet) fuel line fitting. Adapts to 802182A 1 fuel tank connector.

OMC # 176745

Outboard Marine Corp. P/N: 176745  
To fit original equipment OMC fuel tanks. For 6hp-115hp.

Priced individually, sold @ multiples of 2

Quicksilver Branded, Clamshell Package Point of Sale Packaged.

**FITTING**



**802182A 1**

Fits Johnson and Evinrude Fuel tank connector 1/4" NPT threaded fitting to accommodate 22-802196Q, 22-804786Q fuel line Quick disconnect.

Outboard Marine Corp. P/N: 772681

**INLINE FUEL FILTER**



**802128A 1**

For 3/8" Fuel line  
Outboard Marine Corp. P/N: 398319  
Fits Johnson / Evinrude 3/8" Fuel lines.

**FLOAT BOWL GASKET**



**879012**

.062 Viton Material  
Outboard Marine Corp. P/N: 338880

**FLOAT BOWL GASKET**



**878823A 1**

Viton  
Outboard Marine Corp. P/N: 338813

**CARBURETOR NOZZLE GASKET**



**879014**

.062 Viton Material  
Outboard Marine Corp. P/N: 338881  
343512  
336405

Priced individually, sold @ multiples of 5

COMPETITOR PARTS

**NEEDLE AND SEAT**



**802119A 1**

Viton Tip  
Outboard Marine Corp. P/N: 379313  
396522

**CARBURETOR KIT**



**879054A 1**

Viton Gasket Material  
20-75 Hp 1976-2001  
Outboard Marine Corp. P/N: 396701  
Quicksilver Branded

**CARBURETOR KIT**

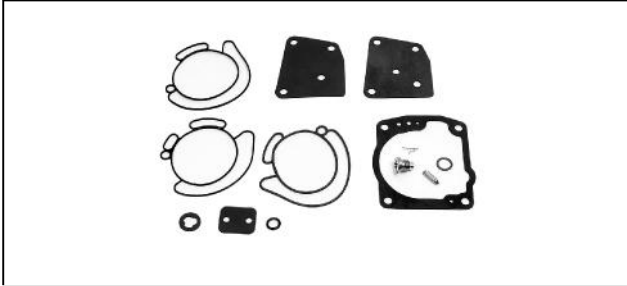

**878952A 2**

Viton Gasket Material  
V4 & V6 60 Degree loop 1991-2001  
Outboard Marine Corp. P/N: 435442  
V-4, V-6 60 Deg. Eagle  
438996  
V-4, V-6 60 Deg. Eagle 1991- thru

**CARBURETOR KIT**



**879055A01**

Viton Gasket Material  
V4 Cross 85-140 Hp 1969-1995  
V6 Cross 150-235 Hp 1976-1991  
Outboard Marine Corp. P/N: 439076

**CARBURETOR KIT**

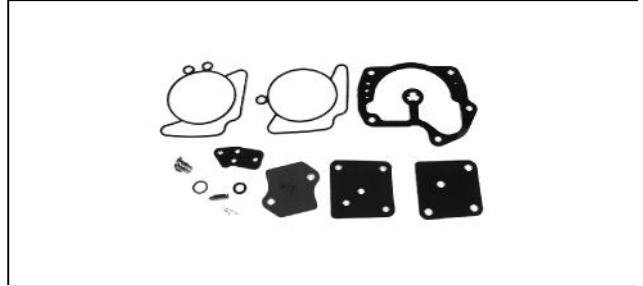

**878951A 2**

Viton Gasket Material  
V4 & V6 90 Degree loop 1988-2001  
Outboard Marine Corp. P/N:  
435676  
V-4 & V-6, 90 Deg. Loopers  
435677  
V-4 & V-6, 90 Deg. Loopers  
435678  
V-4 & V-6, 90 Deg. Loopers  
435752  
V-4 & V-6, 90 Deg. Loopers  
437327  
V-4 & V-6, 90 Deg. Loopers 1988 - thru  
438079  
V-4 & V-6, 90 Deg. Loopers 1991 - thru  
439078  
V-4 & V-6, 90 Deg. Loopers 1988 - thru

**IMPELLER**



**802125**

88 - 235 Hp V4 & V6 1979 - 2002  
Outboard Marine Corp. P/N: 395864  
397131  
435821  
5001594  
5001595

**IMPELLER**



**802332**

9.9, 15 Hp 1974 - 2002  
Outboard Marine Corp. P/N: 386084

**IMPELLER**



**802115**

20 - 35 Hp 1979 - 2002  
Outboard Marine Corp. P/N: 395289

**WATER PUMP REPAIR KIT**



**879539**

With Housing  
90, 115 Hp V4 Loop 1995 - 2002  
120-140 Hp V4 Loop XL 1993 - 2002  
150 - 225 Hp V6 XL 1993 - 2002  
Outboard Marine Corp. P/N: 5001595  
435929  
Contains 435821, 435027, 331107, 310967,  
310585, 306643, 314008, 320943, 321008,  
323626, 332000, 435959, 338484, 338893,  
334897, 331979

**WATER PUMP REPAIR KIT**



**802502A 1**

With Housing  
88,90,100,115,140 Hp V4 Cross Flow 1979 - 95  
150,175,200,235 Hp V6 Cross Flow 1979 - 91  
Outboard Marine Corp. P/N: 434421  
Contains 435821, 435027, 331107, 310967,  
310585, 306643, 314008, 320943, 321008,  
323626, 332000, 435485, 338484, 338893,  
334897, 331979  
5001594  
Contains 435821, 435027, 331107, 310967,  
310585, 306643, 314008, 320943, 321008,  
323626, 332000, 435485, 338484, 338893,  
334897, 331979

**WATER PUMP REPAIR KIT W/O HOUSING**



**879029**

88 - 225 Hp V4 & V6 1979 - 2002  
Outboard Marine Corp. P/N: 5001594  
395060

**ANODE**



**802470T**

Gearcase Housing 3 Cyl.-V6  
Outboard Marine Corp. P/N: 436745  
393023



**YAMAHA****FUEL LINE CONNECTOR****22-804225Q**

3/8 (9.5mm)"Tank End/Engine End" (LARGE Inlet) fuel line fitting.  
Priced individually, sold @ multiples of 2  
Quicksilver Branded, Clamshell Package Point of Sale Packaged.

**INLINE FUEL FILTER****802128A 1**

For 3/8" Fuel line

**IMPELLER****879126**

Yamaha Motor Corp. P/N: 6E5-44352-00-00  
115-250 Hp

**VOLVO**

**EXHAUST BELLOWS KIT**



**803402A 1**

Volvo Penta North America, Inc. P/N: 875848-4  
AQ200, 250, 270, 275, 280, 280DP, 290,  
290DP

**ANODE**



**802474T**

Volvo Penta North America, Inc. P/N: 3855411-9  
3853818-7

OMC

**WATER SEPARATING FUEL FILTER**



**8M0061975**

Fits OMC Fuel Filter spin on housing.  
Replaces OMC # 502905  
Outboard Marine Corp. P/N: 502905  
Quicksilver Branded, Box Point of Sale Packaged.

**IMPELLER - COBRA**



**879141**

Cobra - 1986-1991  
Outboard Marine Corp. P/N: 983895  
Cobra 1986-1991

**WATER PUMP KIT W/O HSG**



**879142**

Does not include impeller housing  
Cobra Dr. 1986-1993  
Outboard Marine Corp. P/N: 984461  
Cobra Dr. 1986-1993

**COBRA OUTDRIVE GASKET SET**



**802172A 1**

Outboard Marine Corp. P/N: 508105

**U-JOINT BELLOWS**



**8M0054761**

Outboard Marine Corp. P/N: 3854127  
All Cobra  
983973  
All Cobra  
987467  
All Cobra

**ANODE**



**802470T**

Gearcase Housing 3 Cyl.-V6  
Outboard Marine Corp. P/N: 436745  
393023

**ANODE**



**802474T**

Outboard Marine Corp. P/N: 3853818  
1987-93 Cobra  
3855411  
1987-93 Cobra  
984513  
1987-93 Cobra



## Part Number to Page Number Reference

394 - 1130A 1 . . . . .	2, 16, 17, 18	17 - 14874A 1 . . . . .	240, 241
11497M . . . . .	80	27 - 15172 4 . . . . .	72
11502M . . . . .	79, 90	15386001 . . . . .	43, 44
47 - 11590M . . . . .	97, 114, 115	15930A15 . . . . .	70, 71
11656T . . . . .	101, 114, 115	32 - 16011 . . . . .	186
27 - 11977A92 . . . . .	207	32 - 16012 . . . . .	182
50 - 12066K10 . . . . .	118, 119	32 - 16021 1 . . . . .	183
50 - 12066Q10 . . . . .	119	16061005 . . . . .	17
50 - 12066T03 . . . . .	119	16061T04 . . . . .	8, 13
26 - 12224 . . . . .	227	16064006 . . . . .	3, 17
12415 . . . . .	116	16115A03 . . . . .	121, 130
12415A 2 . . . . .	116	47 - 16154 1 . . . . .	94, 105, 109
12632A 6 . . . . .	202	47 - 16154 3 . . . . .	94, 104, 107
12632A 7 . . . . .	202	46 - 16156 . . . . .	102, 104, 107
393 - 1280A 1 . . . . .	10, 18, 19, 20	46 - 16156 1 . . . . .	102, 107
32 - 12817 . . . . .	189	46 - 16156 2 . . . . .	103, 109
393 - 1293A 1 . . . . .	10, 17, 18, 19, 20, 21	16156A01 . . . . .	104
13220 . . . . .	164, 169	16159A03 . . . . .	98, 104
13310T 1 . . . . .	41, 43, 44	16253 . . . . .	83, 85
13310T 2 . . . . .	42, 43	16253 2 . . . . .	84, 86
57 - 13457Q . . . . .	201	16253 3 . . . . .	84, 85, 86
57 - 13458Q . . . . .	201	16254 . . . . .	82, 85
27 - 13461A99 . . . . .	120, 134	16254 3 . . . . .	82, 85, 86
13524A 6 . . . . .	152, 157	26 - 16709A 2 . . . . .	225, 227
13524Q06 . . . . .	152	16755Q 1 . . . . .	215, 217
13524T 1 . . . . .	152, 157, 158	16755T 1 . . . . .	215
13524T12 . . . . .	152, 157	17050M . . . . .	81, 88
13536A13 . . . . .	115	17068M . . . . .	80, 90
13536A14 . . . . .	116	1399 - 1717 . . . . .	74, 85, 86, 87, 88
32 - 13556A 1 . . . . .	193	398 - 173 . . . . .	2, 13, 14, 15, 16
43 - 13730A 1 . . . . .	229, 233	17617 . . . . .	205
54 - 13791 . . . . .	120	17649A02 . . . . .	235
13838A 1 . . . . .	205	32 - 18159 1 . . . . .	187
13843A 2 . . . . .	206	87 - 18211 . . . . .	47, 50, 52
27 - 13937 6 . . . . .	72	32 - 18320 . . . . .	187
14034A 3 . . . . .	238, 239	43 - 18411A 2 . . . . .	219, 222
14034F 1 . . . . .	238, 239	43 - 18411A 4 . . . . .	219, 222
14035A 3 . . . . .	238, 239	18495A26 . . . . .	8, 19, 20
14035F 1 . . . . .	238, 239	18545A 1 . . . . .	236
43 - 14063A 1 . . . . .	230, 234	18643A09 . . . . .	202
26 - 14077 . . . . .	227	18643A 5 . . . . .	203
14182M . . . . .	82, 86	18643A 7 . . . . .	203
14184T . . . . .	79, 90	18736A21 . . . . .	23
14334A 3 . . . . .	102, 105, 106, 109, 110	27 - 18785T . . . . .	127, 134, 135
14360A78 . . . . .	67, 68, 69, 70, 71	27 - 18786T . . . . .	127, 135
14360T74 . . . . .	69, 70, 71	32 - 18810 . . . . .	182
14360T75 . . . . .	70, 71	19052A 8 . . . . .	8, 17, 18
14360T77 . . . . .	71	12 - 19183K02 . . . . .	138
57 - 14458Q . . . . .	201	12 - 19183Q02 . . . . .	138
14586 . . . . .	116	19271 1 . . . . .	81, 87, 88
27 - 14697A87 . . . . .	120, 135, 136	19273 . . . . .	84, 87, 88
17 - 14872 . . . . .	241	32 - 19403 . . . . .	187
17 - 14872A 1 . . . . .	239, 241	47 - 19453T . . . . .	95, 105, 106, 109, 110
17 - 14873 . . . . .	240, 241	47 - 19453T 2 . . . . .	99, 109, 110
17 - 14873A 1 . . . . .	239, 241	26 - 19473 . . . . .	227

**Not all parts listed are available for the European, C.I.S., Africa and Middle East Markets.**  
**For more information, please contact your local Mercury, Mariner, MerCruiser or Quicksilver Office.**

## Part Number to Page Number Reference

87 - 19761 . . . . .	47, 51	43 - 41656T . . . . .	231, 234
1399- 2015 . . . . .	75, 86, 87, 88	43 - 41657T . . . . .	230, 234
20270A 2 . . . . .	103, 109, 114	41859M . . . . .	79, 90
47 - 22748 . . . . .	95, 107, 113	32 - 41940 . . . . .	183
25 - 22762 . . . . .	216	47 - 42038Q02 . . . . .	95, 104, 105, 107, 108
23014A 1 . . . . .	64, 67, 68, 69, 70	47 - 42038Q 3 . . . . .	104, 105
392- 2529 . . . . .	235	47 - 42038T 3 . . . . .	99, 107, 108
25661T 1 . . . . .	45, 50, 51, 52, 53, 54, 55, 56, 159, 236	46 - 42089A 2 . . . . .	103, 104, 105, 107, 108
398- 2568T 1 . . . . .	2, 13, 14, 15, 16	46 - 42089A 5 . . . . .	92, 104, 105, 107, 108
27 - 25725 . . . . .	10	27 - 42364A92 . . . . .	121, 130, 131
27 - 25848 . . . . .	72	42431M . . . . .	102, 115
27 - 25849 . . . . .	72	42909A 4 . . . . .	65, 68, 69
27 - 25851 . . . . .	72	27 - 43004A99 . . . . .	121, 133, 134
27 - 29166 . . . . .	10	46 - 43024A09 . . . . .	92, 105, 106
392- 2940 . . . . .	235	46 - 43024A 7 . . . . .	92, 105, 106, 110, 111, 112
392- 2943 . . . . .	235	47 - 43026K06 . . . . .	99, 105, 106, 110, 111, 112, 113, 177
27 - 29586 . . . . .	72	47 - 43026Q06 . . . . .	177
332- 2986A21 . . . . .	7, 20, 21	47 - 43026T 2 . . . . .	95, 105, 106, 110, 111, 112, 113, 177
332- 2986A27 . . . . .	7, 17, 18, 19	26 - 43035A05 . . . . .	139, 144, 145
25 - 29976 . . . . .	226	26 - 43035A 4 . . . . .	139, 144, 145
21 - 30430A 1 . . . . .	63, 67, 68, 69, 70	27 - 43186A 1 . . . . .	207
21 - 30430A 2 . . . . .	63, 66, 67, 68	336- 4318A 2 . . . . .	2, 13, 14, 15
21 - 30430A 3 . . . . .	63, 67, 68, 69, 70	32 - 43437 . . . . .	194
21 - 30430A 7 . . . . .	63, 69, 70	43713 . . . . .	217
21 - 30430A 8 . . . . .	63, 70, 71	27 - 43779A87 . . . . .	121, 132, 133
27 - 31402 . . . . .	73	336- 4409A 4 . . . . .	3, 13, 14, 15
31503A 1 . . . . .	64, 66	17 - 44166 . . . . .	241
25 - 31534 . . . . .	217, 226, 227	17 - 44166T 1 . . . . .	240, 241
43 - 31887 . . . . .	232, 233	17 - 44167A 1 . . . . .	241
25 - 31986 . . . . .	226	57 - 44207Q . . . . .	201
333- 3213A 3 . . . . .	7, 17, 18	46 - 44292A 3 . . . . .	177
32 - 32461 . . . . .	194	46 - 44292Q03 . . . . .	177
26 - 32511A 1 . . . . .	225, 226, 227	50 - 44369A 1 . . . . .	38, 43
32722 . . . . .	170	336- 4528T 2 . . . . .	3, 13, 14, 15
26 - 33144A 2 . . . . .	226, 227	45522A 3 . . . . .	237, 238
32 - 33189 . . . . .	179	43 - 45569A 5 . . . . .	219, 222
25 - 33504 . . . . .	216, 217	32 - 45703 . . . . .	242
33765T . . . . .	155, 156	45706A14 . . . . .	238
33981A06 . . . . .	214	25 - 45710 1 . . . . .	217
34235Q . . . . .	150	17 - 45735 . . . . .	240, 241
34235Q 1 . . . . .	150	17 - 45738 . . . . .	240, 241
34235T . . . . .	150, 156	43 - 45814A 5 . . . . .	220, 222
34235T 1 . . . . .	150, 156	32 - 45973 . . . . .	242
25 - 34821 . . . . .	227	32 - 45974 . . . . .	242
27 - 35982 . . . . .	216, 217	1396- 4656 . . . . .	163, 167
27 - 35996A 1 . . . . .	215, 216	46 - 46893A 6 . . . . .	92, 107, 108
36405 . . . . .	205	47342A22 . . . . .	239
57 - 37619Q . . . . .	201	27 - 47366T . . . . .	217
43 - 37964 . . . . .	233	25 - 47389A 2 . . . . .	238, 239
41219T . . . . .	236	27 - 47453A 1 . . . . .	211
27 - 41244T02 . . . . .	127, 135, 136	47608A 1 . . . . .	203
27 - 41247T01 . . . . .	127, 135, 136	47610A15 . . . . .	195
26 - 41365A 3 . . . . .	139, 143	32 - 47639 . . . . .	180
27 - 41499A88 . . . . .	121, 131	32 - 47642 . . . . .	194
32 - 41642A 3 . . . . .	181	398- 4793 . . . . .	27, 34, 35, 36

## Part Number to Page Number Reference

57 - 48120Q 1 . . . . .	201	1397- 5831 . . . . .	163, 167, 168
57 - 48122Q . . . . .	201	1395- 5898 . . . . .	83, 85
32 - 48132 . . . . .	186	59078Q 3 . . . . .	178
27 - 48164 1 . . . . .	73	59078T 3 . . . . .	178
46 - 48744A 3 . . . . .	92, 108	47 - 59362A 4 . . . . .	176, 177
46 - 48748T 1 . . . . .	176, 177	47 - 59362K08 . . . . .	176
332- 4895A 5 . . . . .	3, 18, 19, 20, 21	47 - 59362Q08 . . . . .	176
332- 4895T 2 . . . . .	3, 17, 18, 19, 20, 21	47 - 59362T 1 . . . . .	177
35 - 49088Q 2 . . . . .	174	47 - 59362T 6 . . . . .	176, 177
35 - 49088T 2 . . . . .	174	32 - 60198 . . . . .	184
332- 4911A 2 . . . . .	7, 15	32 - 60199 . . . . .	184
332- 4911A 8 . . . . .	7, 17	32 - 60200 . . . . .	184
393- 4988T 1 . . . . .	153, 157	32 - 60201 . . . . .	184
393- 4988T 2 . . . . .	155, 157	32 - 60203 . . . . .	184
391- 5075Q 1 . . . . .	155	25 - 60342A 2 . . . . .	237, 238
391- 5075T 1 . . . . .	155, 157	25 - 60342A 3 . . . . .	237, 238
391- 5090Q 1 . . . . .	150	46 - 60366Q 1 . . . . .	109
391- 5090T 1 . . . . .	150, 157	46 - 60366T 1 . . . . .	94, 109, 110, 111
1395- 5109 1 . . . . .	76, 87, 88	60930 . . . . .	200
1399- 5135 . . . . .	74, 86	1395- 6200 . . . . .	75, 87, 88
1399- 5137 . . . . .	80, 86, 87	62092T . . . . .	171
1399- 5198 . . . . .	75, 86, 87	339- 6222A 8 . . . . .	7, 13
1399- 5199 1 . . . . .	76, 86, 87	43 - 62878 . . . . .	222, 224
1399- 5207 . . . . .	72	43 - 62879T 1 . . . . .	221, 224
52146 . . . . .	206	392- 6324Q 1 . . . . .	150
1396- 5238 . . . . .	164, 167	392- 6324T 1 . . . . .	150, 156, 157
32 - 52481 . . . . .	180	392- 6325Q 1 . . . . .	150
398- 5255 . . . . .	25, 31	392- 6325T 1 . . . . .	150, 157
339- 5288T 2 . . . . .	3, 13, 14, 15, 17, 18, 19, 21	27 - 63309 . . . . .	73
53245A 1 . . . . .	64, 66, 67	1397- 6367A 1 . . . . .	163, 166
35 - 53336Q . . . . .	165	32 - 63829 . . . . .	189
35 - 53336T . . . . .	165	63831A 3 . . . . .	195
27 - 54014Q 1 . . . . .	215, 217	63832A 1 . . . . .	195
27 - 54395T . . . . .	217	63832T . . . . .	195
398- 5454A17 . . . . .	27, 34, 35, 36	57 - 64032Q 1 . . . . .	201
398- 5454A26 . . . . .	27, 34	1395- 6452 . . . . .	75, 89, 90
398- 5454A32 . . . . .	28, 36, 37	32 - 64815 . . . . .	184
398- 5454A35 . . . . .	27, 36, 37	27 - 64818Q 4 . . . . .	215, 216, 217
398- 5454A55 . . . . .	28, 37	27 - 64818T 4 . . . . .	215
398- 5454A 7 . . . . .	28, 36, 37	65057T 1 . . . . .	159
32 - 54570 . . . . .	179	27 - 65184A88 . . . . .	209
55278A 1 . . . . .	64, 67, 68, 70	27 - 65373 . . . . .	216
55278A 4 . . . . .	64, 67, 68	65533A 1 . . . . .	216, 217
55278A 5 . . . . .	65, 68, 69	57 - 65607Q . . . . .	201
27 - 55284A 1 . . . . .	121, 134	65864 . . . . .	152, 157
50 - 55601A 2 . . . . .	38, 43	26 - 66303A 1 . . . . .	140, 143
26 - 55682A 1 . . . . .	139, 145, 146	27 - 67751 1 . . . . .	73
43 - 55778A 3 . . . . .	220, 222	68575 3 . . . . .	41, 43, 44
27 - 55896 . . . . .	10	27 - 68714A 7 . . . . .	211
398- 5704A 7 . . . . .	25, 32, 33	57 - 69143Q . . . . .	201
46 - 57234T 1 . . . . .	177	25 - 69201 . . . . .	227
57 - 57298Q . . . . .	201	69354A 2 . . . . .	203
57380 . . . . .	41, 43	32 - 69871 . . . . .	242
332- 5772A 7 . . . . .	7, 16, 17, 18, 19, 20	70886T 2 . . . . .	195
58217Q . . . . .	151	43 - 70933 . . . . .	231, 234

## Part Number to Page Number Reference

43 - 70934T 1	232, 234	802115	248
46 - 70941A 3	92, 107, 108	802119A 1	247
27 - 70974	216	802125	247
32 - 71613	186	802128A 1	246, 249
87 - 71831	151, 157	802172A 1	251
46 - 72774A89	175	802182A 1	246
27 - 72863A88	140	22 - 802196Q	246
27 - 73377 1	73	802332	248
46 - 73640A 2	92, 110, 111	802371A 1	246
27 - 73645A87	121, 133, 134	802470T	248, 251
73723A01	214	802474T	250, 251
32 - 73794	186	802502A 1	248
32 - 73795	186	27 - 802567A98	210
32 - 73796	186	802706A 1	77, 86
57 - 74270Q	201	31 - 803068T 1	225, 227
57 - 74271Q	201	43 - 803069T 1	228, 233
339- 7452A19	8, 14, 15, 16	43 - 803071T 1	228, 233
339- 7452A21	8, 16, 17	43 - 803073T 1	228, 233
74639A 2	216	43 - 803074T 1	228, 233
74639Q02	216	43 - 803076T 1	228, 233
27 - 74830A 3	207	43 - 803079T 1	228, 233
43 - 75325A 3	220, 222	31 - 803080T02	226, 227
27 - 75611A03	212	43 - 803081T02	228, 234
27 - 75611A 2	211	31 - 803082T02	226, 227
27 - 75611A88	208	43 - 803083T02	229, 234
27 - 75611A96	209	31 - 803085T02	226, 227
27 - 75611A98	209	43 - 803087T02	229, 234
75660	43, 44	43 - 803088T02	229, 234
75692	116	43 - 803089T02	229, 234
27 - 75791 1	73	31 - 803090T 1	225, 227
75832T 1	218	43 - 803091T 1	228, 233
1395- 7624	81, 89	43 - 803093T 1	228, 233
76314A 3	26, 32	31 - 803094T 1	225, 227
32 - 76327	181	31 - 803095T 1	225, 227
89 - 76416A 1	159	31 - 803096T 1	225, 227
76850A 2	202	30 - 803097T 1	216, 217
26 - 76868	226, 227	30 - 803098T 1	216, 217
26 - 76868A04	226, 227	30 - 803099T 1	216, 217
27 - 76952	73	43 - 803101T 1	218, 222
26 - 77066A 1	140, 143	43 - 803102T 1	219, 222
46 - 77177A 3	93, 109, 110, 111	43 - 803103T 1	219, 222
32 - 77245	181	43 - 803104T 1	219, 222
77442A 1	238	43 - 803105T 1	219, 222
46 - 77516A 3	93	43 - 803106T 1	219, 222
332- 7778A12	8, 18, 19, 20, 21, 22	43 - 803107T 2	219, 223, 224
46 - 77822A 1	103, 109, 110, 111	43 - 803108T 2	219, 223, 224
27 - 78028A78	121, 132	43 - 803109T 2	219, 223, 224
57 - 78200Q 1	201	43 - 803112T 1	218, 222
1395- 7824	81, 89, 90	43 - 803114T 1	218, 222
1395- 7826	76, 89, 90	43 - 803115T 1	218, 222
27 - 79583 1	127, 135	43 - 803116T 1	218, 222
26 - 79831A 1	140, 144, 145	43 - 803118T 1	219, 222
25 - 79871A 1	238, 239	43 - 803119T 1	219, 222
24 - 80056M	119	43 - 803120T 1	219, 222
27 - 801868	207	91 - 803146A04	120



## Part Number to Page Number Reference

91 -803146T . . . . .	120	32 -805251 . . . . .	187
803402A 1 . . . . .	250	805320A03 . . . . .	237
27 -803508 . . . . .	130	25 -805331 . . . . .	227
27 -803508 2 . . . . .	128, 130	27 -805396A92 . . . . .	210
27 -803508A05 . . . . .	122, 130	27 -805396A95 . . . . .	210
27 -803508A99 . . . . .	74, 122, 130	43 -805448A 1 . . . . .	231, 234
27 -803508T06 . . . . .	122, 130	32 -805469 . . . . .	190
803529T04 . . . . .	67	805536A 2 . . . . .	218
803529T06 . . . . .	66	805561T . . . . .	196
803558T02 . . . . .	8, 10, 11	805561T 1 . . . . .	196
339 -803559A02 . . . . .	3, 11	805759Q01 . . . . .	156
339 -803559T07 . . . . .	3, 10, 11	805759Q 3 . . . . .	154
803559T08 . . . . .	4, 10	805759T05 . . . . .	154, 157
339 -803559T 1 . . . . .	3, 10, 11	805759T 1 . . . . .	156, 157, 158
27 -803663A08 . . . . .	122, 131	805759T 3 . . . . .	154, 157, 158
803704T . . . . .	14	80606M . . . . .	64
803704T01 . . . . .	14	32 -806209 1 . . . . .	182
47 -803748 . . . . .	96, 105	806423T . . . . .	196
47 -803748 1 . . . . .	96, 104, 105	806426T . . . . .	196
47 -803748K01 . . . . .	100	806428T . . . . .	196
47 -803748K02 . . . . .	100	32 -806433 . . . . .	180
47 -803748Q01 . . . . .	104, 105	32 -806635 1 . . . . .	183
47 -803748Q02 . . . . .	105	32 -806636 1 . . . . .	183
46 -803750A02 . . . . .	103, 104, 105	32 -806636 2 . . . . .	183
46 -803750A03 . . . . .	93, 104, 105	3310-806761A 2 . . . . .	168
46 -803750A05 . . . . .	103, 105	3310-806761A 3 . . . . .	168
46 -803750A06 . . . . .	105	32 -806856 . . . . .	182
46 -803750T05 . . . . .	104, 105	27 -806871A96 . . . . .	208
50 -803835T02 . . . . .	38, 44	32 -806993 . . . . .	181
803836 . . . . .	41, 44	26 -807006 . . . . .	227
803837A02 . . . . .	44	23 -807073 . . . . .	241
803844T . . . . .	24, 29	46 -807151A14 . . . . .	175
803844T01 . . . . .	24, 29, 30	807166A 1 . . . . .	200
1395-803861 . . . . .	82, 86, 87	807166A 2 . . . . .	200
47 - 80395M . . . . .	97, 114	807166A 3 . . . . .	200
24 -804024008 . . . . .	118, 119	32 -807201 . . . . .	191
24 -804024T07 . . . . .	118	807252Q 3 . . . . .	178
27 -804115 1 . . . . .	128, 133, 134	807252Q 4 . . . . .	178
804184 . . . . .	84, 88	807252Q 5 . . . . .	178
22 -804225Q . . . . .	249	807252T 3 . . . . .	178
804249T 1 . . . . .	69	807252T 4 . . . . .	178
398 -804262T . . . . .	25, 34, 35	807252T 5 . . . . .	178
804269T 2 . . . . .	8, 12	3310-807312A 1 . . . . .	167, 168
339 -804271T . . . . .	4, 12	807371T . . . . .	196
804316 . . . . .	44	807371T 1 . . . . .	196
804319 . . . . .	42, 44	807372T . . . . .	197
804320 . . . . .	42, 44	32 -807404 . . . . .	188
27 -804345A02 . . . . .	123, 133, 134	32 -807405 . . . . .	189
804346T02 . . . . .	77, 88	32 -807406 . . . . .	189
3302-804689 . . . . .	166, 167, 168	32 -807406 1 . . . . .	189
3302-804844002 . . . . .	163, 166, 167, 168	32 -807407 . . . . .	191
3302-804845 . . . . .	163, 166, 167	32 -807407 1 . . . . .	191
27 -804908A01 . . . . .	141, 144	32 -807407 3 . . . . .	191
17 -805095 . . . . .	241	32 -807661 . . . . .	180
805134A 4 . . . . .	237	27 -807670A03 . . . . .	209

## Part Number to Page Number Reference

27 -807670A96 . . . . .	209	24 -812645T . . . . .	118
27 -807670A97 . . . . .	209	24 -812645T10 . . . . .	118
32 -807697 . . . . .	183	27 -812867A97 . . . . .	123, 132, 133
57 -807755Q04 . . . . .	201	27 -812939T25 . . . . .	127, 131
57 -807755Q05 . . . . .	201	812953 . . . . .	77, 87, 88
27 -807756A01 . . . . .	208	46 -812966A11 . . . . .	93, 109, 110
27 -807756A02 . . . . .	208	46 -812966A12 . . . . .	93, 105, 106
3310-807764A 1 . . . . .	167	27 -814195A93 . . . . .	123, 136
32 -807989 . . . . .	189	47 -81423M . . . . .	98, 115
808029T . . . . .	197	26 -814242 . . . . .	227
32 -808032 . . . . .	185	814453M . . . . .	101, 114
32 -808033 . . . . .	182	814481M . . . . .	79, 90
32 -808044 . . . . .	188	26 -814669A 2 . . . . .	140, 144, 145
32 -808044 1 . . . . .	185	32 -814749 . . . . .	190
32 -808045 . . . . .	185	27 -815076A04 . . . . .	123, 129
808483K 1 . . . . .	154, 157	815113T02 . . . . .	4, 13
808483K 2 . . . . .	154, 157	815279A 2 . . . . .	23
808483Q 1 . . . . .	154	1399- 8153 . . . . .	76, 86
808483Q 2 . . . . .	154	32 -815364 2 . . . . .	185
808483T 3 . . . . .	156, 157	1399- 8154 . . . . .	74, 80, 86
808693A 1 . . . . .	205	815407A 2 . . . . .	155, 157
809064 . . . . .	164, 168, 169	815407Q02 . . . . .	155
809065 . . . . .	164, 168	815407Q 5 . . . . .	153
809449A 1 . . . . .	77, 87	815407T 5 . . . . .	153, 157
809463A 1 . . . . .	44, 45	32 -815412 . . . . .	180
809569 . . . . .	84, 86, 87	32 -815413 . . . . .	180
809570 . . . . .	82	815471T 1 . . . . .	214
809570002 . . . . .	82, 86	26 -815565 . . . . .	227
809570 1 . . . . .	82, 86, 87	26 -815565A02 . . . . .	226, 227
809594A 1 . . . . .	77, 87	27 -815791A00 . . . . .	134, 135
809907002 . . . . .	205	27 -815791A92 . . . . .	123, 134, 135
809908 1 . . . . .	206	815935A 7 . . . . .	239
809909 . . . . .	206	815935T . . . . .	239
91 -809929 . . . . .	206	23 -815950 1 . . . . .	241
91 -809938 . . . . .	207	17 -815953A01 . . . . .	240, 241
810738 . . . . .	84, 89, 90	815954A 7 . . . . .	239
810749 2 . . . . .	75, 89, 90	815954T . . . . .	239
810749 3 . . . . .	75, 89, 90	57 -816034Q . . . . .	201
27 -810846A05 . . . . .	207	816074T . . . . .	197
27 -810846A06 . . . . .	207	32 -816197 . . . . .	188
3310-810929004 . . . . .	164	57 -816295Q . . . . .	201
811038M . . . . .	79, 90	32 -816347 . . . . .	192
1395-811223 1 . . . . .	75, 87, 88	816482T . . . . .	197
811534 . . . . .	168, 169	32 -816504 . . . . .	190
811537 . . . . .	167, 168	26 -816575A 3 . . . . .	226, 227
27 -811547A92 . . . . .	209	26 -816575A 4 . . . . .	140, 145, 146
27 -811572A94 . . . . .	210	26 -816575A 5 . . . . .	141, 145, 146
811598 . . . . .	2, 13	26 -816575A 6 . . . . .	146
811635K 2 . . . . .	153, 156	89 -817109A 2 . . . . .	45, 49, 53, 54, 55, 56, 57
811635Q 2 . . . . .	153	817275 2 . . . . .	105
811635T 3 . . . . .	155, 156	817275A08 . . . . .	94, 106, 113
1395-811690 1 . . . . .	81, 89, 90	817275A09 . . . . .	94, 106, 113
1395-811691 2 . . . . .	77, 89, 90	817275A 1 . . . . .	104, 106, 113
1395-811691 3 . . . . .	77, 89, 90	817275A10 . . . . .	104, 106
57 -812427Q . . . . .	201	817275A 2 . . . . .	104, 105, 106, 110, 111, 112, 113

## Part Number to Page Number Reference

817275A 5 . . . . .	93, 113	826398T 3 . . . . .	67, 68
817275A 6 . . . . .	93, 113	27 -827014A98 . . . . .	211
817275K05 . . . . .	176, 177	43 -827303 . . . . .	230, 234
32 -817435 . . . . .	187	43 -827304T . . . . .	231, 234
27 -818572A98 . . . . .	210	827509A10 . . . . .	9, 16, 17, 18, 19, 20
25 -818573 . . . . .	126, 135, 136	827509A12 . . . . .	9, 16, 17, 21, 22
818574 . . . . .	127, 135, 136	827509T 7 . . . . .	9, 16, 17, 18, 21, 22
32 -818741 . . . . .	188	827589T 1 . . . . .	205
89 -818864T . . . . .	46, 56, 57	827643 . . . . .	205
43 -818928A 2 . . . . .	230, 234	43 -828071A 1 . . . . .	230, 233
89 -818997T 1 . . . . .	46, 53, 54, 55, 56, 57	43 -828073A 1 . . . . .	232, 233
89 -818999A 2 . . . . .	45, 51, 52, 159	43 -828289A 1 . . . . .	230, 233
820620 . . . . .	42, 44	43 -828290T 2 . . . . .	232, 233
26 -820645A 1 . . . . .	141	27 -828319 . . . . .	73
57 -821023Q . . . . .	201	43 -828336A 1 . . . . .	231, 234
26 -821092 . . . . .	227	27 -828553A97 . . . . .	123, 131, 132
46 -821351A 3 . . . . .	104, 105, 109, 110	27 -828925 . . . . .	73
821354A04 . . . . .	100, 105	27 -830270A02 . . . . .	124, 131
821354A 2 . . . . .	100, 105, 109, 110	339-830404T 3 . . . . .	4, 11
32 -821417 . . . . .	188	26 -830749A01 . . . . .	141, 145, 146
32 -821418 . . . . .	188	26 -830749A02 . . . . .	146
821509T01 . . . . .	47, 48, 49	1395- 8318 1 . . . . .	81, 85, 87, 88, 90
398-821935A 3 . . . . .	28, 37	27 -832013A96 . . . . .	124, 132
398-821935A 5 . . . . .	28, 37	398-832074A11 . . . . .	25, 31, 33, 34, 35
84 -822253T20 . . . . .	24	398-832074A 4 . . . . .	26, 34, 35
822374A 6 . . . . .	213	398-832074A 6 . . . . .	26, 31, 32
27 -822420A94 . . . . .	123, 131, 132	398-832075A15 . . . . .	25, 31
43 -822535A 1 . . . . .	231, 234	398-832075A19 . . . . .	26, 32, 33, 34, 35
27 -822844T05 . . . . .	128, 135	398-832075A20 . . . . .	25, 31, 32
823033 . . . . .	4, 13	398-832075A21 . . . . .	25, 31, 33, 34, 35, 36
823034T . . . . .	8, 13	398-832075A 5 . . . . .	26, 32, 33, 34, 35
823426A 1 . . . . .	163, 166, 167, 168, 169	398-832075A 6 . . . . .	26, 34, 35, 36
823427A 1 . . . . .	163, 165, 166	398-832075A 7 . . . . .	26, 33, 34, 35
823547A03 . . . . .	141, 144	398-832075A 8 . . . . .	26, 34, 35, 36
823547A 2 . . . . .	141, 144	398-832075A 9 . . . . .	25, 31
1395-823620 . . . . .	84, 87	339-832757A 4 . . . . .	4, 14, 15, 16, 17, 18, 19, 20, 21, 22
1395-823635 4 . . . . .	77, 87, 88	27 -832934A00 . . . . .	124, 135, 136
823640 1 . . . . .	43, 44	27 -832934A98 . . . . .	124, 135, 136
823640T . . . . .	43, 44	27 -834777 . . . . .	131, 132
1395-823707 2 . . . . .	77, 86, 87	835076 . . . . .	164, 167
823727 . . . . .	167	835389T02 . . . . .	65, 66
823728 . . . . .	164, 167	835399T . . . . .	25, 29, 30
26 -823894 . . . . .	226, 227	835401T02 . . . . .	11
43 -824109A 1 . . . . .	232, 233	835401T06 . . . . .	9, 11
27 -824326A02 . . . . .	208	835401T 1 . . . . .	9, 11
27 -824326A03 . . . . .	208	27 -835427A00 . . . . .	124, 130, 131
27 -824326A93 . . . . .	207	27 -835427A04 . . . . .	124, 130
43 -824517A 1 . . . . .	231, 234	24 -83588M . . . . .	119
27 -825032 . . . . .	128, 132	47 -84027T . . . . .	98, 115
398-825089 1 . . . . .	26, 32, 33	43 -840898A 3 . . . . .	221, 223
825096T01 . . . . .	45, 48, 49	841080T01 . . . . .	173
339-825101T . . . . .	4, 11, 12	27 -841220A03 . . . . .	124, 136
27 -825231A02 . . . . .	123, 131, 132	84141M . . . . .	64
27 -825231A99 . . . . .	131, 132	32 -841452 . . . . .	187
392- 8262 . . . . .	236	27 -84168M . . . . .	137

## Part Number to Page Number Reference

84181T . . . . .	101, 114	47 - 85089T 4 . . . . .	99, 108, 109
84188T . . . . .	102, 115	26 - 85090A 2 . . . . .	140, 143
43 - 841910A01 . . . . .	231, 234	85152T . . . . .	195
27 - 842129A 1 . . . . .	211	21 - 851812A01 . . . . .	66
27 - 842182A 1 . . . . .	211	87 - 851839T02 . . . . .	47, 48
32 - 842412A02 . . . . .	180	851990 . . . . .	44
32 - 842416A 1 . . . . .	179	852082 . . . . .	44
84262M . . . . .	80	398 - 852386T 6 . . . . .	27, 31, 32
84265M . . . . .	81	398 - 852386T 8 . . . . .	24, 27, 30, 31
46 - 84277T . . . . .	101, 115	398 - 852387T 7 . . . . .	27, 31, 32, 33
27 - 843073A06 . . . . .	211	398 - 852387T 9 . . . . .	24, 27, 30, 31
84363T . . . . .	102, 115	27 - 852520 3 . . . . .	128, 135
84419M . . . . .	80, 90, 91	24 - 852778 . . . . .	118
32 - 844475 . . . . .	191	43 - 853593A 1 . . . . .	232, 233
84473T . . . . .	79, 90	43 - 853640A 2 . . . . .	220, 222
32 - 844881 . . . . .	190	43 - 853641A 2 . . . . .	220, 222
32 - 844882 1 . . . . .	186, 191	43 - 853642A 2 . . . . .	220, 222
32 - 847677A01 . . . . .	180	43 - 853643A 2 . . . . .	220, 222
47 - 84797M . . . . .	98, 115	89 - 853654A 1 . . . . .	46, 50, 51, 52, 53, 54, 55, 56, 57, 160, 236
32 - 848178 . . . . .	188	853792A07 . . . . .	101, 105
848192T . . . . .	197	853792T01 . . . . .	100, 109
32 - 848954 . . . . .	191	50 - 853805T03 . . . . .	38, 44
32 - 848955 . . . . .	193	853806 1 . . . . .	42, 44
32 - 848956 . . . . .	190	853807T02 . . . . .	44
32 - 848957 . . . . .	192	89 - 853809001 . . . . .	46, 48
849115T01 . . . . .	197	89 - 853809002 . . . . .	48
849291 . . . . .	197	89 - 853809T . . . . .	50
43 - 849320T . . . . .	223	854247 . . . . .	83, 87, 88
32 - 849604 . . . . .	188	854253 . . . . .	84, 87
849930T02 . . . . .	173	854253 1 . . . . .	85, 87, 88
32 - 849935 . . . . .	189	854256 . . . . .	77, 87
32 - 849936 . . . . .	193	854256 1 . . . . .	78, 87, 88
32 - 849937 . . . . .	193	1397 - 8548 . . . . .	166, 167, 168, 169
32 - 849938 . . . . .	193	27 - 85491A90 . . . . .	121, 131, 132
32 - 849939 . . . . .	192	54 - 855228 . . . . .	120
32 - 849940 . . . . .	193	855546A 1 . . . . .	78, 85
32 - 849941 . . . . .	193	855546A 3 . . . . .	78
32 - 849943 . . . . .	192	855546A 4 . . . . .	78, 85
849952A03 . . . . .	197	43 - 855651A 1 . . . . .	230, 233
850055001 . . . . .	116	43 - 855652T 1 . . . . .	232, 233
50 - 850057K01 . . . . .	118	855685T . . . . .	4, 11
50 - 850057K02 . . . . .	118	54 - 855697 . . . . .	120
50 - 850057K03 . . . . .	118, 119	855713A 3 . . . . .	9, 14, 15, 16
50 - 850057Q03 . . . . .	119	855713A 4 . . . . .	9, 14, 15, 16
89 - 850187T 1 . . . . .	45, 48, 50, 51, 52, 53, 54, 55, 159	855721T 8 . . . . .	24, 29, 30
89 - 850188T 1 . . . . .	46, 50, 51, 52, 159	47 - 85647 . . . . .	95, 113
89 - 850189T . . . . .	46, 50	27 - 85653A87 . . . . .	121, 134
54 - 850241 . . . . .	120	84 - 856624A 2 . . . . .	58
27 - 850470A96 . . . . .	209	32 - 856706 . . . . .	189
850484T 2 . . . . .	155, 157	54 - 856880 . . . . .	120
850484T 3 . . . . .	153, 157	339 - 856991A 1 . . . . .	4, 21, 22
1395 - 8506 . . . . .	76, 89	21 - 857005A 1 . . . . .	64, 67, 68, 69, 70, 71
27 - 850836001 . . . . .	128, 130	398 - 858404T 4 . . . . .	28, 36, 37
47 - 85089 10 . . . . .	95, 105, 108, 109, 110	858452 1 . . . . .	127, 135
54 - 850896 . . . . .	120	27 - 858732A03 . . . . .	124, 133, 134

## Part Number to Page Number Reference

27 -858732T02 . . . . .	124, 134	862077A 1 . . . . .	170
339-858942T 1 . . . . .	5, 11	32 -862124 . . . . .	183
11 -859116K01 . . . . .	214	862132T . . . . .	218
11 -859116Q01 . . . . .	214	32 -862139 . . . . .	184
50 -859168T . . . . .	38, 44	47 -862232A 2 . . . . .	176, 177
27 -859352A01 . . . . .	125, 132, 133	862264A 7 . . . . .	172
27 -859352A02 . . . . .	125, 131, 132	86234A05 . . . . .	170
339-859738T 1 . . . . .	5, 11, 12	86246T . . . . .	171
859772 1 . . . . .	126, 135	86247T . . . . .	171
3310-860070A 2 . . . . .	166	862776A01 . . . . .	175
3310-860071A 2 . . . . .	166	862776A02 . . . . .	175
3310-860071A 4 . . . . .	166	862837T . . . . .	198
32 -860089 1 . . . . .	185	46 -862914A13 . . . . .	175
860125T . . . . .	204	862975A 1 . . . . .	203
32 -860144 . . . . .	184	862975A 2 . . . . .	203
32 -860205 . . . . .	182	863674A04 . . . . .	175
32 -860206 . . . . .	182	863674A05 . . . . .	175
32 -86036Q . . . . .	242	863820T 1 . . . . .	198
32 -86036T . . . . .	242	863832T01 . . . . .	198
57 -861049A 1 . . . . .	202	863842T02 . . . . .	198
57 -861049A 2 . . . . .	202	863904T . . . . .	198
57 -861049Q . . . . .	202	32 -864588 . . . . .	243
3310-861080A 1 . . . . .	167	32 -864589 . . . . .	243
861155A16 . . . . .	172	3310-864942A01 . . . . .	167
861155A 3 . . . . .	172	3310-864943A01 . . . . .	168
861155A 6 . . . . .	172	32 -864959 . . . . .	243
861156A02 . . . . .	173	32 -864960 . . . . .	243
861156A03 . . . . .	173	86 -865202T . . . . .	160
861156A04 . . . . .	173	865329A02 . . . . .	213
861156A 1 . . . . .	172	865330A02 . . . . .	213
32 -861183 . . . . .	179	865380A13 . . . . .	235
27 -861246A05 . . . . .	208	865380A25 . . . . .	235
27 -861246A06 . . . . .	208	865436A02 . . . . .	214
27 -861246A99 . . . . .	209	865436A03 . . . . .	214
32 -861318 . . . . .	192	865437A02 . . . . .	214
32 -861512 . . . . .	186	35 -865461 . . . . .	173
861523A11 . . . . .	203	865496A02 . . . . .	218
861523A 7 . . . . .	203	57 -865615Q01 . . . . .	202
861523A 9 . . . . .	203	57 -865615Q02 . . . . .	201
861554T01 . . . . .	198	57 -865615Q03 . . . . .	202
32 -861590A05 . . . . .	179	57 -865615Q04 . . . . .	201
32 -861634 . . . . .	181	57 -865615Q05 . . . . .	201
861677A 2 . . . . .	172	57 -865615Q06 . . . . .	202
861677T . . . . .	171	57 -865615Q07 . . . . .	201
26 -861694 . . . . .	227	57 -865615Q08 . . . . .	202
57 -861757A 1 . . . . .	202	57 -865615Q09 . . . . .	201
57 -861757Q . . . . .	202	57 -865615Q10 . . . . .	201
57 -861758A 1 . . . . .	202	57 -865615Q11 . . . . .	202
57 -861758Q . . . . .	201	57 -865615Q12 . . . . .	201
57 -861759A 1 . . . . .	202	57 -865635Q01 . . . . .	202
57 -861759Q . . . . .	201	57 -865635Q02 . . . . .	201
861946T . . . . .	198	865960A02 . . . . .	167
862048A 1 . . . . .	171	865961A02 . . . . .	167
862049A 1 . . . . .	171	865962A02 . . . . .	168
57 -862054Q . . . . .	201	86611A 1 . . . . .	237, 239

## Part Number to Page Number Reference

866136A01 . . . . .	218	879029 . . . . .	248
3310-866142A04 . . . . .	167	879054A 1 . . . . .	247
3310-866143A03 . . . . .	168	879055A01 . . . . .	247
866169T01 . . . . .	173	879126 . . . . .	249
866170A01 . . . . .	173	879141 . . . . .	251
86617A17 . . . . .	24, 30	879142 . . . . .	251
86617A20 . . . . .	24, 29, 30, 31	879147T69 . . . . .	30
32 -866331 . . . . .	194	339 -879147T71 . . . . .	5, 11
27 -866449A01 . . . . .	215	50 -879150A85 . . . . .	40, 44
866464A02 . . . . .	239	1395-879194011 . . . . .	82, 87, 88
866465A02 . . . . .	239	1395-879194024 . . . . .	75, 87, 88
866524A01 . . . . .	239	1399-879194026 . . . . .	78, 86
86704A10 . . . . .	25, 31	879194T52 . . . . .	199
1395- 8673 . . . . .	83, 85, 86, 87, 88	879194T60 . . . . .	199
24 -86857T01 . . . . .	118, 119	57 -879288Q20 . . . . .	202
32 -87117 1 . . . . .	183	57 -879288Q21 . . . . .	202
87173A10 . . . . .	238	879288T34 . . . . .	152
32 -87234 . . . . .	242	879288T46 . . . . .	199
32 -87235 . . . . .	242	50 -879345T77 . . . . .	40, 44
87399A 2 . . . . .	237, 238, 239	879346A31 . . . . .	58
87399A 3 . . . . .	237, 239	879346A32 . . . . .	58
25 -87400A 2 . . . . .	238, 239	879346A33 . . . . .	58
87411A 3 . . . . .	239	879346A34 . . . . .	58
87411A 6 . . . . .	239	879346A35 . . . . .	58
87412A 3 . . . . .	239	879346A36 . . . . .	58
32 -87558 . . . . .	243	879346A37 . . . . .	58
32 -87559 . . . . .	243	879346A38 . . . . .	59
1397- 8760 . . . . .	163, 167	879346A39 . . . . .	59
1397- 8767Q . . . . .	165	879346A40 . . . . .	59
1397- 8767T . . . . .	165	879346A41 . . . . .	59
339-877807A 2 . . . . .	5, 11, 12	879346A42 . . . . .	59
84 -878074A 2 . . . . .	61	879346A43 . . . . .	59
43 -878087A 2 . . . . .	229, 233	879346A44 . . . . .	59
43 -878087A 4 . . . . .	229, 233	879346A45 . . . . .	59
398-878143T05 . . . . .	28, 31, 32, 33	879346A46 . . . . .	59
878453 . . . . .	127, 135, 136	879346A47 . . . . .	60
26 -878461 2 . . . . .	62	879346A48 . . . . .	60
26 -878461 3 . . . . .	61	879346A49 . . . . .	60
26 -878461 4 . . . . .	61	879346A50 . . . . .	60
26 -878462 . . . . .	62	879346A51 . . . . .	60
26 -878463 2 . . . . .	61	879346A52 . . . . .	60
26 -878463 3 . . . . .	61	879346A53 . . . . .	60
26 -878463 4 . . . . .	62	879539 . . . . .	248
26 -878463 6 . . . . .	62	27 -879855A04 . . . . .	125, 133, 134
26 -878464 2 . . . . .	62	27 -880552A07 . . . . .	125, 136
26 -878464 6 . . . . .	62	339-880615T01 . . . . .	5, 12
26 -878464 8 . . . . .	62	43 -880805A 1 . . . . .	42, 44
26 -878465 . . . . .	62	880890A02 . . . . .	69
26 -878466 . . . . .	61	880890T 1 . . . . .	69, 70
43 -878617A 2 . . . . .	229, 233	339-880892001 . . . . .	5, 12
878823A 1 . . . . .	246	339-880892T . . . . .	5, 12
878951A 2 . . . . .	247	339-880893T10 . . . . .	6, 12
878952A 2 . . . . .	247	84 -881262A 2 . . . . .	58
879012 . . . . .	246	398-881336A03 . . . . .	34, 35
879014 . . . . .	246	398-881336T 2 . . . . .	28, 35

## Part Number to Page Number Reference

881352T	47, 49	27 - 889924A02	210
881356001	47, 49	27 - 889924A03	210
50 - 881368T 2	38, 44	89031A 1	65, 69, 70
881370T	44	89031A 2	65, 70, 71
881371T 1	41, 44	89031A 3	65, 69, 70
91 - 881814A 1	61	89031A 4	65, 71
882751	46, 49, 160	891730A01	85, 87
882751A04	48, 49, 160	891736T	235
882751A 1	46, 48, 49, 50, 51, 52, 53, 54, 55, 56, 57, 160	27 - 89221 1	73
882751A 3	47, 49	27 - 89221A80	122, 135, 136
88302A 1	213	27 - 89221A88	122, 135
883166A 2	236	50 - 892339T01	39, 44
883169A 1	236	26 - 89238A 2	140, 145, 146
43 - 883473A 2	221, 223, 224	50 - 893886T	39, 44
43 - 883473A 3	221, 223, 224	50 - 893887T	39, 44
43 - 883473A 4	221, 223, 224	50 - 893888T	39, 44
43 - 883476A 2	221, 223, 224	50 - 893890T	39, 44
43 - 883476A 3	221, 223, 224	50 - 893891T	39, 43, 44
43 - 883476A 4	220, 223, 224	50 - 893892T	39, 43, 44
43 - 883479A 2	221, 223, 224	50 - 893893	39, 43
43 - 883479A 3	221, 223, 224	895338	117
43 - 883479A 4	221, 223, 224	23 - 89574	241
27 - 883599A02	125, 132, 133	895764A01	139
26 - 88397A 1	225, 227	27 - 896142A07	125, 135, 136
884391	135, 136	32 - 89653	181
84 - 88439A25	23	89690T	195
84 - 88439A26	23	32 - 896998	190
84 - 88439A50	23	32 - 896999	190
27 - 88449A32	122, 132, 133	32 - 897142	190
27 - 887810A03	125, 136	32 - 897145	187
27 - 887810A04	125, 136	32 - 89718 1	179
27 - 887848002	129, 136	32 - 89718 3	179
27 - 887848003	129, 136	32 - 89730 1	191
43 - 887903A 1	221, 223, 224	32 - 89749 1	192
43 - 887906A 1	221, 223, 224	27 - 897534A07	126, 133, 134
43 - 887909A 1	221, 223, 224	898101288	85
32 - 88794	182	24 - 898101316	118
32 - 88795	181	27 - 898101928	122, 129
32 - 88795 2	185	898101T01	28, 31
1397- 8880	166	27 - 898101T41	129, 131
339- 888309	6, 12	898103245	85
888320T	47, 49	27 - 898103A67	126, 129
50 - 888333T 1	38, 44	898103A68	85
888335	44	339- 898103T	6, 11
888339A 1	41, 44	898103T58	6, 10
54 - 888441	120	898253T23	155, 157
27 - 888658A03	141, 146	898253T24	6, 18, 19, 20
27 - 888658A04	141, 146	898253T28	153, 157
888686T	104, 106	50 - 898265001	40, 44
888687A 1	106	50 - 898265003	40, 44
47 - 888689	97, 106	50 - 898265005	40, 43
54 - 888988019	120	50 - 898265008	40, 44
889246A16	104	50 - 898265009	40, 44
889275T	172	50 - 898265010	38, 40, 43
27 - 889924A01	210	898265015	43, 44

## Part Number to Page Number Reference

898265016 . . . . .	43, 44	8M0058164 . . . . .	171
43 - 898440A03 . . . . .	230, 233	8M0058226 . . . . .	23
43 - 898441A01 . . . . .	233	22 - 8M0058388 . . . . .	138
392 - 8989 . . . . .	235	22 - 8M0058389 . . . . .	138
899106T . . . . .	67	26 - 8M0058390 . . . . .	138
899106T01 . . . . .	66, 67, 68	26 - 8M0058391 . . . . .	138
89977A 1 . . . . .	66, 67	43 - 8M0060003 . . . . .	221, 223, 224
47 - 89980 . . . . .	95, 107, 108	43 - 8M0060004 . . . . .	221, 223, 224
47 - 89980T 1 . . . . .	99, 107, 108	43 - 8M0060005 . . . . .	221, 223, 224
47 - 89981 . . . . .	95, 107, 108	8M0061040 . . . . .	94, 106
47 - 89981T 1 . . . . .	99, 107, 108	8M0061335 . . . . .	154, 157
47 - 89982 . . . . .	96, 108	8M0061975 . . . . .	251
47 - 89982T 1 . . . . .	99, 108	84 - 8M0062009 . . . . .	160
47 - 89983T . . . . .	96, 109, 110, 111, 114	84 - 8M0062010 . . . . .	160
47 - 89983T 1 . . . . .	100, 109, 110, 111	84 - 8M0062011 . . . . .	160
47 - 89984Q 5 . . . . .	112, 177	84 - 8M0062012 . . . . .	161
47 - 89984T 3 . . . . .	96, 97	84 - 8M0062013 . . . . .	161
47 - 89984T 4 . . . . .	96, 110, 111, 112, 113, 177	84 - 8M0062014 . . . . .	161
47 - 89984T 5 . . . . .	96, 100, 110, 111, 112, 113, 177	84 - 8M0062015 . . . . .	161
899883229 . . . . .	9, 14, 15	84 - 8M0062016 . . . . .	161
27 - 8M0024565 . . . . .	129, 133, 134, 135, 136	84 - 8M0062017 . . . . .	161
57 - 8M0028573 . . . . .	201	84 - 8M0062018 . . . . .	161
27 - 8M0033476 . . . . .	129, 136	84 - 8M0062019 . . . . .	161
50 - 8M0033984 . . . . .	41, 44	84 - 8M0062020 . . . . .	161
8M0044575 . . . . .	78, 85, 86	84 - 8M0062021 . . . . .	161
8M0044576 . . . . .	78, 86	84 - 8M0062022 . . . . .	162
8M0044577 . . . . .	78, 86	84 - 8M0062023 . . . . .	162
300 - 8M0044991 . . . . .	6, 11, 12	84 - 8M0062024 . . . . .	162
300 - 8M0045124 . . . . .	6, 11	84 - 8M0062025 . . . . .	162
57 - 8M0045227 . . . . .	202	84 - 8M0062026 . . . . .	162
27 - 8M0045278 . . . . .	128, 132, 133	84 - 8M0062027 . . . . .	162
3310 - 8M0045397 . . . . .	166	8M0062084 . . . . .	152, 157
27 - 8M0045578 . . . . .	210	32 - 8M0062309 . . . . .	194
8M0045696 . . . . .	199	32 - 8M0062614 . . . . .	194
57 - 8M0045986 . . . . .	201	32 - 8M0062634 . . . . .	194
27 - 8M0046714 . . . . .	126, 135	32 - 8M0062665 . . . . .	194
27 - 8M0046715 . . . . .	126, 135	32 - 8M0062666 . . . . .	193
35 - 8M0046751 . . . . .	174	8M0065064 . . . . .	142, 145, 146
35 - 8M0046752 . . . . .	174	8M0065070 . . . . .	240, 241
3310 - 8M0047212 . . . . .	169	8M0065258 . . . . .	44
8M0047313 . . . . .	7, 14	8M0069808 . . . . .	206
27 - 8M0049885 . . . . .	128, 131	32 - 8M0071007 . . . . .	179
8M0050085 . . . . .	60	8M0073435 . . . . .	170
8M0050324 . . . . .	60	27 - 8M0077448 . . . . .	142, 143
8M0050786 . . . . .	164, 169	339 - 8M0077471 . . . . .	5, 11, 12, 19, 20, 21, 22
8M0051206 . . . . .	204	339 - 8M0077473 . . . . .	6, 21, 22
8M0051418 . . . . .	205	8M0078858 . . . . .	94, 106
27 - 8M0052705 . . . . .	128, 130, 131	27 - 8M0079064 . . . . .	126, 131
8M0052921 . . . . .	139	8M0080264 . . . . .	99, 107
8M0054761 . . . . .	251	43 - 8M0080756 . . . . .	219, 222
8M0056334 . . . . .	24, 29	8M0082721 . . . . .	154, 156
8M0056379 . . . . .	11	27 - 8M0082878 . . . . .	142, 143
8M0057697 . . . . .	49	27 - 8M0082881 . . . . .	142, 143
8M0057716 . . . . .	142, 145	27 - 8M0082882 . . . . .	142, 143
27 - 8M0057763 . . . . .	126, 135	27 - 8M0082883 . . . . .	142, 143



## Part Number to Page Number Reference

27 -8M0082884 . . . . .	142, 143	50 - 90892A 2 . . . . .	118
22 -8M0083059 . . . . .	138	392- 9089Q . . . . .	151
22 -8M0083060 . . . . .	138	392- 9089T . . . . .	151, 156, 157
8M0084173 . . . . .	23	1395- 9169 1 . . . . .	83, 86, 87
3310-8M0084193 . . . . .	166	91755T . . . . .	79, 90
3310-8M0084194 . . . . .	167	43 - 92320T . . . . .	232, 233
27 -8M0084273 . . . . .	123, 131	1395- 9258 1 . . . . .	81, 85, 86, 87, 88
21 -8M0084275 . . . . .	63, 67, 68	1395- 9262 1 . . . . .	76, 85, 86, 87, 88
21 -8M0084276 . . . . .	63, 68, 69	32 - 92837 . . . . .	187
21 -8M0084277 . . . . .	63, 69, 70	92864 . . . . .	171
8M0085593 . . . . .	218	1395- 9293 . . . . .	83, 86, 87
300-8M0088059 . . . . .	29, 34, 35	93224A 1 . . . . .	103, 107, 108
50 -8M0088064 . . . . .	41, 44	93247A 7 . . . . .	235
8M0088080 . . . . .	142, 145	32 - 93436 . . . . .	185
8M0088081 . . . . .	143, 145	35 - 93568 . . . . .	165
8M0088351 . . . . .	23	57 - 93658Q . . . . .	201
8M0090764 . . . . .	78, 85	3302- 9407 . . . . .	166, 167
27 -8M0090776 . . . . .	129, 133, 134	57 - 94290Q . . . . .	201
8M0094529 . . . . .	94, 106	94500M . . . . .	79, 90
8M0094530 . . . . .	101, 106	393- 9459Q 1 . . . . .	154
8M0095485 . . . . .	216, 217	393- 9459T 1 . . . . .	154, 156
50 -8M0096343 . . . . .	41, 44	94993A12 . . . . .	213
8M0096940 . . . . .	160	27 - 94996Q 2 . . . . .	215, 217
8M2001321 . . . . .	172	27 - 94996T 2 . . . . .	215
57 -8M2018590 . . . . .	201	27 - 95220A 1 . . . . .	143, 144
57 -8M2018984 . . . . .	202	95259 . . . . .	84, 85
27 -8M6000366 . . . . .	135	95263 1 . . . . .	85
8M6001106 . . . . .	156, 157	95263A 1 . . . . .	81
8M6001217 . . . . .	157	47 - 95289 2 . . . . .	96, 107
8M6001218 . . . . .	156	24 - 95484M . . . . .	119
8M6001219 . . . . .	151, 156, 157	47 - 95533M . . . . .	98, 115
8M6001221 . . . . .	151, 157	47 - 95611M . . . . .	98, 114, 115
8M6001222 . . . . .	153, 157	95661T . . . . .	102, 115
8M6001224 . . . . .	152, 157	1395- 9594 . . . . .	83, 87, 88
8M6001249 . . . . .	156, 157	89 - 96054T . . . . .	45, 50, 51, 52, 53, 54, 55, 56, 57, 159
8M6001250 . . . . .	151, 157	43 - 96084A 4 . . . . .	229, 233
8M6001251 . . . . .	151, 156	43 - 96084A 7 . . . . .	229, 233
8M6001252 . . . . .	153, 157	398- 9610A19 . . . . .	27, 36, 37
8M6001253 . . . . .	152, 157	398- 9610A 5 . . . . .	27, 36, 37
8M6001254 . . . . .	151, 156	46 - 96148A 8 . . . . .	110, 111, 112, 113, 176, 177
23 - 90203 . . . . .	241	46 - 96148Q 8 . . . . .	176
1395- 9022 . . . . .	82, 86, 87	46 - 96148T 1 . . . . .	103, 110, 111, 112, 113
1395- 9023 . . . . .	76, 87	46 - 96148T 8 . . . . .	176
1395- 9024 . . . . .	75, 80, 87	89 - 96158T . . . . .	45, 50, 51, 52, 53, 54, 55, 56, 57, 159, 236
1395- 9026 . . . . .	76, 86	32 - 96246A 4 . . . . .	185
1395- 9027 . . . . .	74, 86	27 - 96281T01 . . . . .	127, 134, 135
90363A 1 . . . . .	65, 71	47 - 96305M . . . . .	97, 114
27 - 90430 1 . . . . .	73	27 - 96324M . . . . .	140, 146
3302- 9046 . . . . .	166, 167	96325T . . . . .	101, 114
27 - 90484A88 . . . . .	122, 134, 135	1395- 9648 1 . . . . .	76, 86
26 - 90562 . . . . .	226	1395- 9650 . . . . .	76, 87
90643 . . . . .	42, 43, 44	1395- 9651 . . . . .	75, 87
90643 1 . . . . .	42, 44	3302- 9655 1 . . . . .	166, 167, 168
90643 2 . . . . .	42, 44	96562 . . . . .	41, 43, 44
90645 . . . . .	42, 43, 44	96563T . . . . .	44

**Not all parts listed are available for the European, C.I.S., Africa and Middle East Markets.**  
**For more information, please contact your local Mercury, Mariner, MerCruiser or Quicksilver Office.**

## Part Number to Page Number Reference

1397- 9669 . . . . .	166, 167, 168, 169	NLA . . . . .	169
57 - 96834Q . . . . .	201		
47 - 97108M . . . . .	98, 115		
32 - 97385 2 . . . . .	192		
32 - 97385 3 . . . . .	192		
97432A 2 . . . . .	203		
1395- 9761 1 . . . . .	64, 66, 67, 74, 80, 86, 87		
97667T . . . . .	80, 90		
392- 9766Q 1 . . . . .	156		
392- 9766T 1 . . . . .	155, 157		
97793T . . . . .	101, 115		
10 - 97934A 1 . . . . .	213		
32 - 98033A 3 . . . . .	181		
98337T . . . . .	206		
98337T 6 . . . . .	206		
98703A10 . . . . .	238, 239		
98703A26 . . . . .	239		
98703A 3 . . . . .	238, 239		
98703T . . . . .	238, 239		
98704A10 . . . . .	238, 239		
98704A26 . . . . .	239		
98704A 3 . . . . .	238, 239		
98704T . . . . .	238, 239		
398- 9873A38 . . . . .	26, 32, 33		
398- 9873A 4 . . . . .	28, 36, 37		
27 - 98769 1 . . . . .	64		
1399- 99 . . . . .	72		
99155T 1 . . . . .	178		
99155T 2 . . . . .	178		
46 - 99157A02 . . . . .	103, 105, 108, 109		
46 - 99157T 2 . . . . .	94, 105, 108, 109		
23 - 99291T . . . . .	241		
99356A 1 . . . . .	195		
99356A 2 . . . . .	196		
99370A 2 . . . . .	200		
27 - 99386A96 . . . . .	211		
32 - 99904K . . . . .	243		
32 - 99904Q . . . . .	243		
47 - 99971M . . . . .	98, 115		
F10265 . . . . .	83, 87		
F12044 . . . . .	2		
F12139-1 . . . . .	2		
F12181-1 . . . . .	2		
F15190 . . . . .	44		
27 -F433168 . . . . .	74		
27 -F433406 . . . . .	74		
47 -F436065-2 . . . . .	97		
27 -F440906 . . . . .	74		
47 -F462065 . . . . .	97		
27 -F481836 . . . . .	74		
F528068 . . . . .	116		
F664068 . . . . .	116		
47 -F84065 . . . . .	97		
FK1061 . . . . .	139		
FK1063-2 . . . . .	139		

**OE to Quicksilver Cross Reference**

**Chris Craft**

OE Part No.	Description	QS Part No.
<b>Chris Craft</b>		
16.69-00039	Points	8M6001250
16.69-00049	Points	34235T
16.69-00051	Rotor	8M6001251
16.69-00051	Rotor	58217Q
16.69-00052	Distributor Cap	393- 9459Q 1
16.69-00149	Rotor	8M6001224
16.83-90006	Fuel Pump Filter	35- 49088Q 2
16.96-00049	Points	34235Q
F16900148	Distributor Cap	391- 5075Q 1

**Chrysler Inboard**

OE Part No.	Description	QS Part No.
<b>Chrysler Inboard</b>		
18495A26	Switch Box Assy.	18495A26
21-42990-A10	Diaphragm Kit	21-857005A 1
21-42990-A9	Diaphragm Kit	21-857005A 1
2421173	Points	8M6001219
2421820	Points	8M6001250
2808870	Points	8M6001219
332-7778A6	Switch Box Assembly	332- 7778A12
332-7778A9	Switch Box Assembly	332- 7778A12
339-7370A13	Ignition Coil	339-832757A 4
398-8320755A4	Ignition Stator Kit	398-832075A21
398-8320755A6	Ignition Stator Kit	398-832075A 6
4142817	Distributor Cap	392- 9766Q 1
47-19453	Water Pump Impeller	47- 19453T
47-42038-2	Water Pump Impeller	47- 42038Q02
47-43026-2	Water Pump Impeller	47- 43026T 2
47-803631T	Water Pump Impeller	47- 89984T 4
47-85089-3	Water Pump Impeller	47- 85089 10
47-F694065	Water Pump Impeller	47- 89984T 4
694065	Water Pump Impeller	47- 89984T 4
868096	Rotor	8M6001224
90643	Drive Retainer Kit	90643
90644	Drive Retainer Kit	90643
F0101790	Inlet Needle & Seat Assembly	1395- 9258 1
F016311	Carburetor Repair Kit	809449A 1
F12042-1	Condenser	394- 1130A 1
F15100	Drive Retainer Kit	90643
F664068	Thermostat	75692

**Crusader**

OE Part No.	Description	QS Part No.
<b>Crusader</b>		
20117	Points	8M6001250
20222	Distributor Cap	391- 5075Q 1
20223	Rotor	8M6001224
3000121	Distributor Cap	393- 4988T 2
3000122	Rotor	65864
3000124	Points	8M6001221

OE Part No.	Description	QS Part No.
<b>Crusader</b>		
32722	Fuel Pump	32722
38070	Distributor Cap	808483T 3
38071	Rotor	8M6001253
41058	Points	8M6001219
41074	Rotor	392- 9089T
41074	Rotor	392- 9089Q
41076	Distributor Cap	392- 9766Q 1
41089	Rotor	392- 9089T
41089	Rotor	392- 9089Q
45334	Carburetor Repair Kit	823426A 1

**Honda Marine**

OE Part No.	Description	QS Part No.
<b>Honda Marine</b>		
19210-ZW1-003	Water Pump Impeller	47- 43026T 2
19210-ZWL-303	Water Impeller Repair Kit	47- 43026Q06

**McCulloh/Scott-Atwater**

OE Part No.	Description	QS Part No.
<b>McCulloh/Scott-Atwater</b>		
38850115	Condenser	F12181-1

**Outboard Marine Corp.**

OE Part No.	Description	QS Part No.
<b>Outboard Marine Corp.</b>		
172527	Tune-Up Kit	34235Q 1
173619	Tune-Up Kit	391- 5090Q 1
173690	Tune-Up Kit	392- 6325Q 1
173829	Tune-Up Kit	392- 6324Q 1
176745	Fuel Line Connector	22-802196Q
310953	V-Belt	57- 48120Q 1
311606	V-Belt	57- 69143Q
311606	V-Belt	57- 64032Q 1
312456	Fuel Pump Filter	35- 49088Q 2
336405	Carburetor Nozzle Gasket	879014
338813	Float Bowl Gasket	878823A 1
338880	Float Bowl Gasket	879012
338881	Carburetor Nozzle Gasket	879014
343512	Carburetor Nozzle Gasket	879014
378065	Thermostat	75692
379313	Needle and Seat	802119A 1
380538	Points	34235T
380541	Distributor Cap	393- 9459Q 1
381690	Fuel Pump Filter	35- 49088Q 2
382135	Points	8M6001250
383087	Float Assembly	1395- 9594
383615	Carburetor Repair Kit	823427A 1
383918	Carburetor Repair Kit	823426A 1
384735	Rotor	8M6001251
384735	Rotor	58217Q

# REFERENCE & INDEX

OE Part No.	Description	QS Part No.
<b>Outboard Marine Corp.</b>		
384743	Carburetor Repair Kit	823426A 1
3850809	Fuel Pump - Electric	861155A 6
3850810	Fuel Pump - Electric	861155A 6
3850812	Cross & Bearing	75832T 1
3853548	Ignition Coil	898253T24
3853801	Rotor	392- 9089T
3853801	Rotor	392- 9089Q
3853815	Distributor Cap	392- 9766Q 1
3853818	Anode	802474T
3854127	U-Joint Bellows	8M0054761
3854260	Distributor Cap	811635T 3
3854261	Rotor	8M6001254
3854311	Rotor	8M0062084
3854331	Distributor Cap	850484T 2
3854548	Distributor Cap	808483T 3
3854549	Rotor	8M6001253
3854620	Fuel Pump - Electric	861155A 6
3855411	Anode	802474T
3857985	Fuel Pump - Electric	861155A 6
3857986	Fuel Pump - Electric	861155A 6
3858261	Fuel Pump - Electric	861155A 6
385949	Starter Drive	68575 3
386084	Impeller	802332
387683	Starter Drive	13310T 1
393023	Anode	802470T
393354	Drive Retainer Kit	90643
393659	Thermostat	75692
395060	Water Pump Repair Kit w/o Housing	879029
395289	Impeller	802115
395864	Impeller	802125
396522	Needle and Seat	802119A 1
396701	Carburetor Kit	879054A 1
397131	Impeller	802125
398319	Inline Fuel Filter	802128A 1
434421	Water Pump Repair Kit	802502A 1
434841	Thermostat	75692
435442	Carburetor Kit	878952A 2
435676	Carburetor Kit	878951A 2
435677	Carburetor Kit	878951A 2
435678	Carburetor Kit	878951A 2
435752	Carburetor Kit	878951A 2
435821	Impeller	802125
435929	Water Pump Repair Kit	879539
436745	Anode	802470T
437327	Carburetor Kit	878951A 2
438079	Carburetor Kit	878951A 2
438996	Carburetor Kit	878952A 2
439076	Carburetor Kit	879055A01
439078	Carburetor Kit	878951A 2
5001594	Impeller	802125
5001594	Water Pump Repair Kit	802502A 1
5001594	Water Pump Repair Kit w/o Housing	879029
5001595	Impeller	802125
5001595	Water Pump Repair Kit	879539
502905	Water Separating Fuel Filter	8M0061975

OE Part No.	Description	QS Part No.
<b>Outboard Marine Corp.</b>		
508105	Cobra Outdrive Gasket Set	802172A 1
508626	Thermostat	75692
509395	Fuel Pump	86234A05
509404	Fuel Pump	8M0058164
509407	Fuel Pump	8M0073435
509408	Fuel Pump	862077A 1
509409	Fuel Pump	86246T
509410	Fuel Pump	86247T
582995	Ignition Coil	802371A 1
584477	Ignition Coil	802371A 1
772681	Fitting	802182A 1
85R-4541	Carburetor Repair Kit	1396- 5238
908034	Carburetor Fuel Filter	35- 53336Q
909818	V-Belt	57- 96834Q
909818	V-Belt	57- 13458Q
909971	V-Belt	57- 48120Q 1
910305	Hose - Molded	32- 52481
910305	Hose - Molded	32- 41940
910305	Hose - Molded	32- 87117 1
910305	Hose - Molded	32- 16021 1
910305	Hose - Molded	32- 19403
910305	Hose - Molded	32- 89730 1
910305	Hose - Molded	32- 89749 1
910305	Hose	32-8M0062614
912418	V-Belt	57- 96834Q
912424	Hose - Molded	32- 52481
912424	Hose - Molded	32- 41940
912424	Hose - Molded	32- 87117 1
912424	Hose - Molded	32- 16021 1
912424	Hose - Molded	32- 19403
912424	Hose - Molded	32- 89730 1
912424	Hose - Molded	32- 89749 1
912424	Hose	32-8M0062614
912714	V-Belt	57- 37619Q
912714	V-Belt	57- 13458Q
912793	Hose - Molded	32- 88795
912793	Hose - Molded	32- 92837
912793	Hose - Molded	32- 12817
912793	Hose - Molded	32-848956
913488	Hose - Molded	32- 52481
913488	Hose - Molded	32- 41940
913488	Hose - Molded	32- 87117 1
913488	Hose - Molded	32- 16021 1
913488	Hose - Molded	32- 19403
913488	Hose - Molded	32- 89730 1
913488	Hose - Molded	32- 89749 1
913488	Hose	32-8M0062614
915717	Cross & Bearing	75832T 1
915735	Ignition Coil	898253T24
979659	Carburetor Repair Kit	823426A 1
980152	Distributor Cap	33765T
980893	Points	8M6001219
982063	Fuel Pump	62092T
982209	Distributor Cap	391- 5075Q 1
982211	Rotor	8M6001224

OE Part No.	Description	QS Part No.
<b>Outboard Marine Corp.</b>		
982240	Fuel Pump	86234A05
982384	Carburetor Repair Kit	823427A 1
982537	Carburetor Repair Kit	1396- 4656
982538	Carburetor Repair Kit	1396- 4656
982539	Carburetor Repair Kit	1396- 5238
982880	Rotor	392- 9089T
982880	Rotor	392- 9089Q
983864	Carburetor Repair Kit	823426A 1
983871	Float Assembly	1395- 9594
983895	Impeller - Cobra	879141
983973	U-Joint Bellows	8M0054761
984401	Distributor Cap	392- 9766Q 1
984461	Water pump kit w/o Hsg	879142
984513	Anode	802474T
985064	Solenoid	89- 76416A 1
985602	Fuel Pump	86234A05
985603	Fuel Pump	86234A05
986643	Distributor Cap	811635T 3
986651	Rotor	8M6001254
986865	Fuel Pump - Electric	861155A 6
987136	Points	8M6001219
987467	U-Joint Bellows	8M0054761
987894	Points	8M6001219
987925	Tune-Up Kit	392- 6325Q 1
987926	Tune-Up Kit	392- 6324Q 1

**Pleasure Craft**

OE Part No.	Description	QS Part No.
<b>Pleasure Craft</b>		
R103001	Rotor	8M6001224
R103004	Rotor	392- 9089T
R108001	Distributor Cap	391- 5075Q 1
R114001	Points	8M6001250
R114002	Points	8M6001219
R114004	Points	8M6001250
R130001	Solenoid	89- 76416A 1
RA108003	Distributor Cap	393- 4988T 2
RA108003	Distributor Cap	392- 9766Q 1
RN0116	Carburetor Repair Kit	1396- 4656
RN0116-2	Carburetor Repair Kit	1396- 4656
RN0118	Carburetor Repair Kit	1396- 5238
RN0120	Carburetor Repair Kit	1396- 5238
RO85035	Power Trim Hose	32- 86036Q

**Suzuki**

OE Part No.	Description	QS Part No.
<b>Suzuki</b>		
65750-95510	Fuel Line Connector	22-804225Q

**Volvo Penta North America, Inc.**

OE Part No.	Description	QS Part No.
<b>Volvo Penta North America, Inc.</b>		
3850809	Fuel Pump - Electric	861155A 6
3850810	Fuel Pump - Electric	861155A 6
3850812	Cross & Bearing	75832T 1
3853801	Rotor	392- 9089T
3853815	Distributor Cap	392- 9766Q 1
3853818-7	Anode	802474T
3854260-1	Distributor Cap	811635T 3
3854261-9	Rotor	8M6001254
3854311-2	Rotor	8M0062084
3854331-0	Distributor Cap	850484T 2
3854548-9	Distributor Cap	808483T 3
3854549-7	Rotor	8M6001253
3854620	Fuel Pump - Electric	861155A 6
3855411-9	Anode	802474T
3857265-7	Trim Pump Assembly	865380A13
3857985	Fuel Pump - Electric	861155A 6
3857986	Fuel Pump - Electric	861155A 6
3858261	Fuel Pump - Electric	861155A 6
826423	Hose - Molded	32- 88795
826423	Hose - Molded	32- 92837
826423	Hose - Molded	32- 12817
826423	Hose - Molded	32-848956
829207	V-Belt	57- 48120Q 1
834985-4	Carburetor Repair Kit	823426A 1
835304-7	Points	8M6001250
835576-0	Carburetor Fuel Filter	35- 53336Q
835705-5	Points	8M6001219
838513	Hose - Molded	32- 89653
841070-6	Distributor Cap	392- 9766Q 1
841907-9	Rotor	392- 9089T
841907-9	Rotor	392- 9089Q
845792	Hose - Molded	32- 88795
845792	Hose - Molded	32- 92837
845792	Hose - Molded	32- 12817
845792	Hose - Molded	32-848956
852928	Trim Pump Assembly	865380A13
855845-4	Rotor	392- 9089T
855845-4	Rotor	392- 9089Q
855845-4	Rotor	8M6001224
855846-2	Points	8M6001219
855889-2	Carburetor Repair Kit	823426A 1
856306	Hose - Molded	32- 89653
875848-4	Exhaust Bellows Kit	803402A 1
950813	V-Belt	57- 64032Q 1
950818	V-Belt	57- 48120Q 1
952141	V-Belt	57- 96834Q

**Yamaha Motor Corp.**

OE Part No.	Description	QS Part No.
<b>Yamaha Motor Corp.</b>		
646-44352-01-00	Impeller	47- 80395M
648-24411-00-00	Fuel Pump Diaphragm	80606M
662-44352-00-00	Impeller	47- 95611M

Not all parts listed are available for the European, C.I.S., Africa and Middle East Markets.  
For more information, please contact your local Mercury, Mariner, MerCruiser or Quicksilver Office.

# REFERENCE & INDEX

OE Part No.	Description	QS Part No.
<b>Yamaha Motor Corp.</b>		
662-44352-01-00	Impeller	47- 95611M
663-24411-00-00	Fuel Pump Diaphragm	84141M
663-W0078-00-00	Repair Kit	84188T
663-W0078-A0-00	Repair Kit	84188T
677-24411-02-00	Fuel Pump Diaphragm	84262M
677-24471-01-00	Fuel Pump Diaphragm	84265M
679-W0078-A0-00	Repair Kit	84363T
682-44352-01-00	Impeller	47- 84027T
682-W0078-A1-00	Repair Kit	46- 84277T
689-44352-02-00	Impeller	47- 84797M
689-W0078-04-00	Repair Kit	97793T
689-W0078-04-00	Repair Kit	42431M
689-W0078A3-00	Repair Kit	97793T
689-W0078-A4-00	Repair Kit	42431M
689-W0078-A6-00	Impeller	47- 95611M
689-W0078-A6-00	Repair Kit	95661T
696-W0093-02-00	Carburetor Repair Kit	84419M
6E0-44352-00-00	Impeller	47- 96305M
6E5-44352-00-00	Impeller	879126
6E7-W0093-04-00	Carburetor Repair Kit	814481M
6EO-W0078-A2-00	Repair Kit	96325T
6F5-44352-00-00	Impeller	47- 99971M
6G0-44352-00-00	Water Pump Impeller	47- 95533M
6G1-24471-00-00	Fuel Pump Diaphragm	11497M
6G1-44352-00-00	Impeller	47- 11590M
6G1-W0078-A1-00	Repair Kit	11656T
6G1-W0093-00-00	Carburetor Repair Kit	11502M
6H3-44352-00-00	Impeller	47- 81423M
6H3-44352-00-00	Water Pump Impeller	47- 97108M

**A**

Adaptor CDM Kit . . . . .	9
Adaptor Kit CDM . . . . .	9
Alternator Harness Service End . . . . .	58
Anchor Front Pin . . . . .	240, 241
Anchor Front Pin Kit . . . . .	239
Anchor Front Pin Rear . . . . .	240
Anchor Kit Front Pin . . . . .	239
Anchor Rear Pin . . . . .	240, 241
Anode . . . . .	248, 250, 251
Armature, P/T Pump Motor . . . . .	235

**B**

Base Kit Water Pump . . . . .	176, 177
Base Water Pump Kit . . . . .	176, 177
Battery Cable . . . . .	23
Battery Cable Kit . . . . .	23
Bearing Cross . . . . .	218
Bearing Kit Seal . . . . .	225, 226
Bearing Seal Kit . . . . .	225, 226
Bell Housing Hose . . . . .	194
Bellows Exhaust Kit . . . . .	250
Bellows Kit Exhaust . . . . .	250
Bellows Shift Cable . . . . .	216
Bellows U-Joint . . . . .	251
Belt Kit Serpentine . . . . .	202
Belt Serpentine . . . . .	201, 202
Belt Serpentine Kit . . . . .	202
Bolt Engine Kit . . . . .	213
Bolt Kit Engine . . . . .	213
Boost Pump Kit . . . . .	172
Brush Kit . . . . .	10
Brush Set . . . . .	235

**C**

Cable Battery . . . . .	23
Cable Battery Kit . . . . .	23
Cable Shift . . . . .	214
Cable Shift Bellows . . . . .	216
Cable Shift Kit . . . . .	214

Cap Kit Rotor . . . . .	153, 154
Cap Rotor Kit . . . . .	153, 154
Carburetor Float Assembly . . . . .	85
Carburetor Fuel Filter . . . . .	165
Carburetor Gasket Kit . . . . .	164
Carburetor Gasket Nozzle . . . . .	246
Carburetor Gasket Set . . . . .	75
Carburetor Kit . . . . .	247
Carburetor Kit Gasket . . . . .	164
Carburetor Kit Repair . . . . .	76–80, 163, 164
Carburetor Nozzle Gasket . . . . .	246
Carburetor Repair Kit . . . . .	76–80, 163, 164
CDI Unit . . . . .	8, 9
CDM Adaptor Kit . . . . .	9
CDM Assembly Module . . . . .	9
CDM Harness Seal . . . . .	61
CDM Module Assembly . . . . .	9
Check Valve Kit . . . . .	63
Circulating Hose Pump . . . . .	179, 180
Circulating Pump Hose . . . . .	179, 180
Clamp Hose . . . . .	120
Clamp Hose Kit . . . . .	120
Coil . . . . .	5, 6
Coil, Ignition Charging . . . . .	24
Coil Harness Seal Ignition . . . . .	61
Coil Ignition . . . . .	2–6, 246
Coil Ignition Harness Seal . . . . .	61
Coil Ignition Kit . . . . .	7
Coil Kit Ignition . . . . .	7
Commutator Head . . . . .	235, 236
Complete Water Pump . . . . .	94
Condenser . . . . .	2
Connector Fuel Line . . . . .	246, 249
Cooler Oil . . . . .	195–199
Coupler Engine . . . . .	202, 203
Cover Assembly . . . . .	103
Cover Float Bowl Gasket . . . . .	72
Crank Sensor Harness . . . . .	61
Crimping Tool . . . . .	120
Cylinder Head Gasket . . . . .	129
Cylinder Trim Kit O-Ring . . . . .	237, 238

**D**

DDT Harness Seal . . . . .	61
Diaphragm Fuel Pump . . . . .	64, 80, 81
Diaphragm Gasket Kit . . . . .	64, 74, 75, 80
Diaphragm Kit . . . . .	64, 65, 80
Direct Harness Injector . . . . .	60
Direct Harness Injector Seal . . . . .	62
Direct Injector Harness . . . . .	60
Direct Injector Harness Seal . . . . .	62
Distributor Cap . . . . .	154–156
Drain Gasket Screw . . . . .	138
Drain Screw . . . . .	138
Drain Screw, Gear Case . . . . .	138
Drain Screw Gasket . . . . .	138
Drain Screw Seal . . . . .	138
Drive Installation Kit . . . . .	215
Drive Kit . . . . .	42, 43
Driven Gear . . . . .	221
Drive Retainer Kit . . . . .	42

**E**

Electric Fuel Pump . . . . .	172, 173
Engine Bolt Kit . . . . .	213
Engine Coupler . . . . .	202, 203
Engine Drive Plate . . . . .	203, 204
Engine Mount Rear . . . . .	213
Exhaust Bellows Kit . . . . .	250

**F**

Filter Fuel . . . . .	246, 249
Filter Fuel Pump . . . . .	174
Filter Fuel Water Separating . . . . .	251
Fitting . . . . .	246
Float Assembly . . . . .	83–85
Float Bowl Gasket . . . . .	246
Front Anchor Pin . . . . .	240, 241
Front Anchor Pin Kit . . . . .	239
Front Anchor Pin Rear . . . . .	240
Fuel Connector Line . . . . .	246, 249
Fuel Filter . . . . .	173, 246, 249
Fuel Filter Carburetor . . . . .	165

Fuel Filter Pump . . . . .	174
Fuel Filter Water Separating . . . . .	251
Fuel Injector Harness . . . . .	60
Fuel Line Connector . . . . .	246, 249
Fuel Pump . . . . .	65, 170–173
Fuel Pump/Cooler Kit . . . . .	173
Fuel Pump Assembly . . . . .	66
Fuel Pump Diaphragm . . . . .	64, 80, 81
Fuel Pump Electric . . . . .	172, 173
Fuel Pump Filter . . . . .	174

**G**

Gasket . . . . .	10, 64, 72–74, 128
Gasket, Cylinder Head . . . . .	129
Gasket Carburetor Kit . . . . .	164
Gasket Carburetor Nozzle . . . . .	246
Gasket Carburetor Set . . . . .	75
Gasket Cover Float Bowl . . . . .	72
Gasket Diaphragm Kit . . . . .	64, 74, 75, 80
Gasket Drain Screw . . . . .	138
Gasket Float Bowl . . . . .	246
Gasket Float Bowl Cover . . . . .	72
Gasket Head . . . . .	127–129
Gasket Kit Carburetor . . . . .	164
Gasket Kit Diaphragm . . . . .	64, 74, 75, 80
Gasket Outdrive Set . . . . .	251
Gasket Overhaul Set . . . . .	207–211
Gasket Set . . . . .	74, 75, 120–126, 140, 210–212
Gasket Set, Lower Unit . . . . .	141, 142
Gasket Set Carburetor . . . . .	75
Gasket Set Outdrive . . . . .	251
Gasket Set Overhaul . . . . .	207–211
Gasket Water Pump . . . . .	211
Gear . . . . .	230
Gear Case Drain Screw . . . . .	138
Gearcase Seal Kit . . . . .	142
Gear Drive . . . . .	222
Gear Driven . . . . .	221
Gear Kit . . . . .	219–221
Gear Pinion . . . . .	231, 232
Gear Repair Kit . . . . .	218, 219, 228, 229



Gear Set . . . . . 229–231  
 Gimbal Ring Kit . . . . . 213

**H**

Harness Alternator Service End . . . . . 58  
 Harness Connector . . . . . 58–60  
 Harness DDT Seal . . . . . 61  
 Harness Direct Injector . . . . . 60  
 Harness Direct Seal Injector . . . . . 62  
 Harness Fuel Injector . . . . . 60  
 Harness Repair . . . . . 58–60  
 Harness Repair Kit . . . . . 160–162  
 Harness Sensor Crank . . . . . 61  
 Harness Sensor Seal MAP . . . . . 61  
 Harness Wiring . . . . . 24  
 Head Commutator . . . . . 235, 236  
 Head Gasket . . . . . 127–129  
 Head O-Ring . . . . . 126, 127  
 Head Seal . . . . . 127  
 Hose . . . . . 180–194  
 Hose Bell Housing . . . . . 194  
 Hose Circulating Pump . . . . . 179, 180  
 Hose Clamp . . . . . 120  
 Hose Clamp Kit . . . . . 120  
 Hose Kit Clamp . . . . . 120  
 Hose Power Trim . . . . . 242, 243  
 Housing, Upper . . . . . 103, 104  
 Housing, Water Pump . . . . . 103

**I**

Ignition Assembly Stator . . . . . 24, 25, 27, 28  
 Ignition Charging Coil . . . . . 24  
 Ignition Coil . . . . . 2–6, 246  
 Ignition Coil Kit . . . . . 7  
 Ignition Harness Coil Seal . . . . . 61  
 Ignition Module . . . . . 9  
 Ignition Stator Assembly . . . . . 24, 25, 27, 28  
 Ignition Stator Kit . . . . . 25, 26, 28  
 Impeller . . . . . 97, 98, 247–249, 251  
 Impeller Kit . . . . . 98, 99, 175  
 Impeller Pump Kit . . . . . 96, 99, 100, 176, 177

Impeller Repair Kit . . . . . 98–101  
 Impeller Water Pump . . . . . 94–98  
 Injector Fuel Harness . . . . . 60  
 Injector Harness Fuel . . . . . 60  
 Inlet Needle Assembly . . . . . 82, 83  
 Inlet Seat Needle Assembly . . . . . 81  
 Installation Hardware, Sterndrive . . . . . 214  
 Installation Kit, Drive . . . . . 215

**M**

MAP Harness Sensor Seal . . . . . 61  
 Module Assembly CDM . . . . . 9  
 Motor Armature, P/T Pump . . . . . 235  
 Motor Assembly Starter . . . . . 38–41  
 Motor Starter Assembly . . . . . 38–41  
 Motor Starter Kit . . . . . 38

**N**

Needle Inlet Assembly . . . . . 82, 83  
 Needle Inlet Seat Assembly . . . . . 81  
 Needle Seat . . . . . 247  
 Nozzle Carburetor Gasket . . . . . 246

**O**

Oil Cooler . . . . . 195–199  
 Oil Pump . . . . . 205, 206  
 Oil Pump Harness Seal . . . . . 62  
 Oil Pump Seal Harness . . . . . 62  
 O-Ring Cylinder Kit Trim . . . . . 237, 238  
 O-Ring Cylinder Trim Kit . . . . . 237, 238  
 O-Ring Kit Trim Cylinder . . . . . 237, 238  
 O-Ring Trim Cylinder Kit . . . . . 237, 238  
 Outdrive Gasket Set . . . . . 251  
 Overhaul Gasket Set . . . . . 207–211  
 Overhaul Kit Repair . . . . . 236  
 Overhaul Kit Trim Cylinder . . . . . 237  
 Overhaul Repair Kit . . . . . 236  
 Overhaul Set Gasket . . . . . 207–211

**P**

P/T Pump Motor Armature . . . . . 235

Pick Up Tube . . . . . 206

Pinion Gear . . . . . 231, 232

Pin Kit, Rear Anchor . . . . . 239, 240

Points . . . . . 2, 150, 151

Powerhead Gasket Set . . . . . 121, 123, 126

Power Steering Oil Cooler . . . . . 199

Power Trim Hose . . . . . 242, 243

Power Trim Kit Relay . . . . . 47

Power Trim Relay . . . . . 46, 47, 160

Power Trim Relay Kit . . . . . 47

Power Trim Sender . . . . . 237

Power Trim Solenoid . . . . . 45, 46, 159

Pump Assembly Trim . . . . . 235

Pump Base Kit Water . . . . . 176, 177

Pump Circulating Hose . . . . . 179, 180

Pump Fuel . . . . . 170–173

Pump Fuel Diaphragm . . . . . 64, 80, 81

Pump Fuel Electric . . . . . 172, 173

Pump Fuel Filter . . . . . 174

Pump Gasket Water . . . . . 211

Pump Hose Circulating . . . . . 179, 180

Pump Impeller Kit . . . . . 96, 99, 100, 176, 177

Pump Impeller Water . . . . . 94–98

Pump Kit, Boost . . . . . 172

Pump Kit Base Water . . . . . 176, 177

Pump Kit Housing . . . . . 176

Pump Kit Impeller . . . . . 96, 99, 100, 176, 177

Pump Kit Repair . . . . . 248

Pump Kit Repair Water . . . . . 94, 176, 248

Pump Motor . . . . . 235

Pump Oil . . . . . 205, 206

Pump Oil Harness Seal . . . . . 62

Pump Oil Seal Harness . . . . . 62

Pump Repair Kit . . . . . 248

Pump Repair Kit Water . . . . . 94, 176, 248

Pump Seal Fuel Harness . . . . . 62

Pump Seal Harness Oil . . . . . 62

Pump Seal Oil Harness . . . . . 62

Pump Water . . . . . 92–94

Pump Water Impeller . . . . . 94–98

**R**

Rear Anchor Pin Kit . . . . . 239, 240

Rectifier . . . . . 23

Regulator Voltage . . . . . 23

Relay . . . . . 46–48, 160

Relay Kit Power Trim . . . . . 47

Relay Starter . . . . . 45

Repair Kit . . . . . 101, 102

Repair Kit, Carburetor . . . . . 78

Repair Kit, Harness . . . . . 160–162

Repair Kit Carburetor . . . . . 76–80, 163, 164

Repair Kit Gear . . . . . 218, 219, 228, 229

Repair Kit Impeller . . . . . 98–101

Repair Kit Overhaul . . . . . 236

Repair Kit Pump . . . . . 248

Repair Kit Pump Water . . . . . 94, 176, 248

Repair Kit Transom Seal . . . . . 216

Repair Kit Water Impeller . . . . . 98–100

Repair Kit Water Pump . . . . . 94, 176, 248

Repair Overhaul Kit . . . . . 236

Repair Pump Kit . . . . . 248

Repair Pump Kit Water . . . . . 94, 176, 248

Repair Pump Water Kit . . . . . 94, 176, 248

Repair Seal Transom Kit . . . . . 216

Reservoir . . . . . 236

Reservoir Kit . . . . . 236

Reservoir Kit Update . . . . . 236

Reservoir Update Kit . . . . . 236

Retainer Kit Drive . . . . . 42, 43

Reverse Gear . . . . . 232, 233

Rotor . . . . . 10, 151–153

Rotor Cap Kit . . . . . 153, 154

Rotor Sender Kit . . . . . 237

**S**

Seal Harness Fuse . . . . . 62

Seal Harness Injector Direct . . . . . 62

Seal Harness Kit . . . . . 61

Seal Kit . . . . . 139–143, 225, 226

Seal Kit Bearing . . . . . 225, 226

Seal Kit Harness . . . . . 61

Seal Kit Propshaft . . . . . 226  
 Seal Kit Transom Repair . . . . . 216  
 Seal MAP Harness Sensor . . . . . 61  
 Seal MAP Sensor Harness . . . . . 61  
 Sender Kit Rotor . . . . . 237  
 Sender Kit Temperature . . . . . 116  
 Sender Power Trim . . . . . 237  
 Sender Rotor Kit . . . . . 237  
 Sensor Crank Harness . . . . . 61  
 Separating Water Fuel Filter . . . . . 251  
 Serpentine Belt . . . . . 201, 202  
 Serpentine Belt Kit . . . . . 202  
 Shift Cable . . . . . 214  
 Shift Cable Bellows . . . . . 216  
 Shift Cable Kit . . . . . 214  
 Shutter Water . . . . . 200  
 Solenoid . . . . . 45, 46, 159, 160, 236  
 Solenoid Power Trim . . . . . 45, 46, 159  
 Solenoid Starter . . . . . 45  
 Spring Set . . . . . 235  
 Starter Drive . . . . . 41, 42  
 Starter Drive Assembly . . . . . 41–43  
 Starter Gear . . . . . 41, 42  
 Starter Motor . . . . . 40, 41  
 Starter Motor Assembly . . . . . 38–41  
 Starter Motor Kit . . . . . 38  
 Starter Relay . . . . . 45  
 Starter Solenoid . . . . . 45  
 Stator . . . . . 29  
 Stator Harness Seal . . . . . 62  
 Stator Ignition Assembly . . . . . 24, 25, 27, 28  
 Stator Ignition Kit . . . . . 25, 26, 28  
 Sterndrive Installation Hardware . . . . . 214  
 Switch Box Assembly . . . . . 7–9

**T**

Thermostat . . . . . 116, 117  
 Thermostat Kit . . . . . 178  
 Tool Crimping . . . . . 120  
 Transom Repair Seal Kit . . . . . 216  
 Trim Cylinder Kit O-Ring . . . . . 237, 238

Trim Cylinder Kit Overhaul . . . . . 237  
 Trim Cylinder O-Ring Kit . . . . . 237, 238  
 Trim O-Ring Cylinder Kit . . . . . 237, 238  
 Trim Pump Assembly . . . . . 235  
 Tube, Pick Up . . . . . 206  
 Tune-Up Kit . . . . . 150

**U**

U-Joint Bellows . . . . . 251  
 Upper Housing . . . . . 102–104

**V**

V-Belt . . . . . 201  
 Voltage Regulator . . . . . 23

**W**

Water Impeller Repair Kit . . . . . 101  
 Water Inlet Plug Kit . . . . . 139  
 Water Pump . . . . . 92–94  
 Water Pump, Complete . . . . . 94  
 Water Pump Base Kit . . . . . 176, 177  
 Water Pump Gasket . . . . . 211  
 Water Pump Housing . . . . . 103  
 Water Pump Impeller . . . . . 94–98  
 Water Pump Kit . . . . . 93, 94  
 Water Pump Kit Base . . . . . 176, 177  
 Water Pump Kit Repair . . . . . 94, 176, 248  
 Water Pump Repair Kit . . . . . 94, 176, 248  
 Water Pump Upper Repair Kit . . . . . 94  
 Water Repair Impeller Kit . . . . . 98–100  
 Water Separating Fuel Filter . . . . . 251  
 Water Shutter . . . . . 200  
 Water Temperature Sender . . . . . 115, 116  
 Wiring Harness . . . . . 24  
 Wtr Hsg pump . . . . . 251  
 Wtr pump Hsg . . . . . 251

